



**Before returning this product
to the store of purchase**

Contact Dee Zee if you experience the following problems:

- Missing Parts
- Installation Problems/Questions
- Warranty Questions

1.800.779.2102

Hours of operation: 8am - 5pm CST, Mon-Friday

Review complete warranty policy and register your product at:

www.deezee.com



Dee Zee Nerfstep Installation Instructions

Congratulations on your purchase of a quality Dee Zee product. Dee Zee is recognized as having the highest quality running boards and accessories on the market today. We have earned this reputation by offering our customers a product they can be proud to place on their vehicles. Dee Zee meets all the criteria of manufacturing a custom-fit product which guarantees it to be the easiest product to install.

Note: Please take time to read all of the instructions before beginning this installation.

Cleaning instructions: To maintain the bright finish of your Dee Zee nerfsteps, clean with a mild detergent and use a high grade automotive type wax. **DO NOT USE ABRASIVE CLEANERS ON THIS PRODUCT!**





If you should happen to have any questions with this product or you have an installation question, please feel free to call us at:

1-800-779-8222

If you would like to find out more information on Dee Zee's products, please feel free to visit our website at:

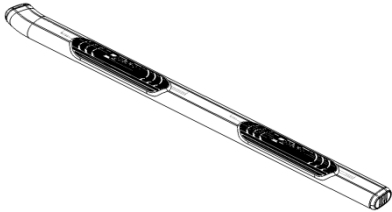
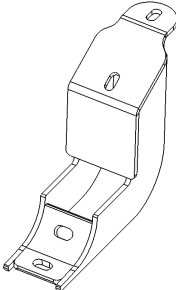
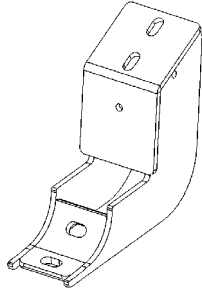
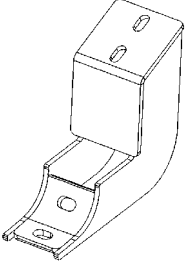
WWW.DEEZEE.COM

DZ 17060 / DZ 17560 (2007 – Current) Toyota Tundra Double Cab Pickup

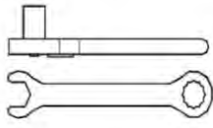
<p>A Nerfstep</p>  <p>NB 17060L/R NB 17560L/R 1LH / 1RH</p>	<p>B Front Mounting Bracket</p>  <p>B 1622P X2</p>	<p>C Middle Mounting Bracket (Holes in Front and Sides)</p>  <p>B 1619P X2</p>	
<p>D Rear Mounting Bracket</p>  <p>B 1616P X2</p>	<p>E 8mm X 25mm Flange Head Bolt</p>  <p>PN 525 X12</p>	<p>F 6mm Hex Flange Bolt</p>  <p>PN 846-CHY X12</p>	
<p>G 6mm Washer</p>  <p>PN 865B X12</p>			
<p>Tools Required</p> <p>Ratchet / Wrench 13mm / 10mm</p> 			

1 Driver Side Nerfstep:

Place the Front, Middle, and Rear Mounting Brackets (B, C, D) onto the Driver Side Nerfstep (A) as shown below and secure into place with the 6mm Hex Flange Bolts (F) and 6mm Washer (G). Leave loose for later adjustment.

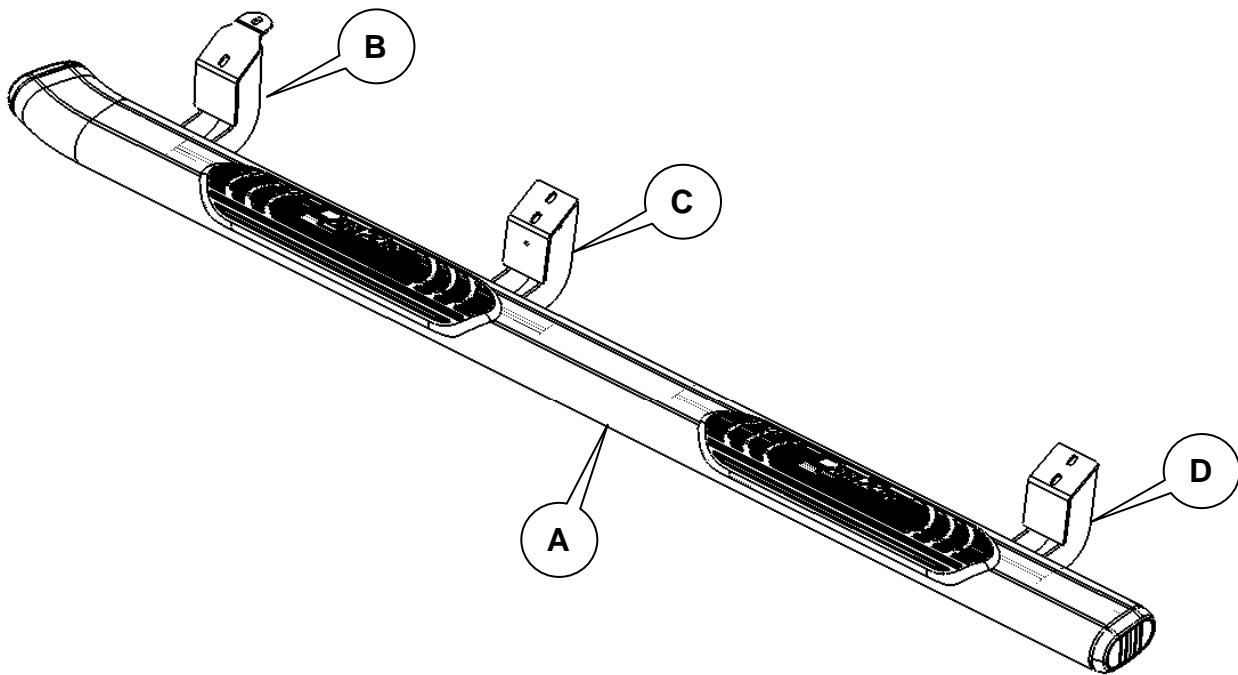

2

Installation Driver Side Step.

- (a) Remove the five (5) bolts located in the side step mounting holes under the vehicle and discard (Fig. 1-1).
- (b) Place the side step under the vehicle and line-up the mounting holes on the brackets with the mounting holes on the vehicle (Fig. 1-2).
- (c) By hand place the 8mm flange bolts (E) into the holes and hand tighten (Fig. 1-3).
- (d) Set the tube, by shifting the tube to the rear of the vehicle until the tube stops.
- (e) Tighten all six (6) flange bolts mounting the braces to the tube.
- (f) Tighten all six (6) flange bolts mounting the braces to the vehicle.

Install Passenger Side Step.

- (g) Repeat steps 1 and 2 for the passenger side.

