



**Before returning this product
to the store of purchase**

Contact Dee Zee if you experience the following problems:

- Missing Parts
- Installation Problems/Questions
- Warranty Questions

1.800.779.2102

Hours of operation: 8am - 5pm CST, Mon-Friday

Review complete warranty policy and register your product at:

www.deezee.com



Dee Zee Nerf step Installation Instructions

Congratulations on your purchase of a quality Dee Zee product. Dee Zee is recognized as having the highest quality running boards and accessories on the market today. We have earned this reputation by offering our customers a product they can be proud to place on their vehicles. Dee Zee meets all the criteria of manufacturing a custom-fit product which guarantees it to be the easiest product to install.

Note: Please take time to read all of the instructions before beginning this installation.

WARNING! Please check for wiring or other obstructions before drilling any holes into the vehicle. If it is necessary to drill any holes into the vehicle, Dee Zee recommends putting a sealant or rust inhibitor around all holes drilled into the body of the vehicle.

WARNING! It is the sole responsibility of the vehicle owner to check for tire clearance.

WARNING! It is unlawful and dangerous to ride on running boards or side box boards while the vehicle is in motion.

Cleaning instructions: To maintain the bright finish of your Dee Zee nerfsteps, clean with a mild detergent and use a high grade automotive type wax. DO NOT USE ABRASIVE CLEANERS ON THIS PRODUCT!

















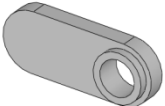

If you should happen to have any questions with this product or you have an installation question, please feel free to call us at:

1-800-779-8222

If you would like to find out more information on Dee Zee's products, please feel free to visit our website at:

WWW.DEEZEE.COM

**DZ 17132 / DZ 17632
(2002-2008) Dodge Ram 8' Box Pickup**

<p>A Nerf step</p>  <p>NB 17126R / NB 17626R NB 17126L / NB 17626L 1LH / 1RH</p>	<p>B Right Mounting Bracket - Front</p>  <p>B 1807RP X1</p>	<p>C Left Mounting Bracket - Front</p>  <p>B 1807LP X1</p>	<p>D Right Mounting Bracket - Rear</p>  <p>B 1808RP X1</p>
<p>E Left Mounting Bracket - Rear</p>  <p>B 1808LP X1</p>	<p>F 3/8 Hex Head Bolt</p>  <p>PN 114B X5</p>	<p>G 5/16 flat washer</p>  <p>PN 325B X14</p>	<p>H 3/8 Hex Nut</p>  <p>B 90B X5</p>
<p>I Long threaded plate Driver's Side Only</p>  <p>PN 554 X1</p>	<p>J Short threaded plate</p>  <p>PN 714 X5</p>	<p>K 3/8 lockwasher</p>  <p>PN 89B X10</p>	<p>L 8mm hex head bolt</p>  <p>PN 567 X5</p>
<p>M Left Nerf Step Bracket</p>  <p>B 1650LP X2</p>	<p>N Right Nerf Step Bracket</p>  <p>B 1650RP X2</p>	<p>O 6mm Hex Flange Bolt</p>  <p>PN 743 X8</p>	<p>P 3/8 Flat Washer</p>  <p>PN 569 X8</p>
<p>Q 1/4" Flat Washer</p>  <p>PN 72B X16</p>	<p>R 1/4 x 1 1/4" Hex Head Bolt</p>  <p>PN 78 X8</p>	<p>S 1/4" Hex Nut</p>  <p>PN 71B X8</p>	

Tools Required

Ratchet / Wrench
13mm / 10mm
7/16"
9/16"

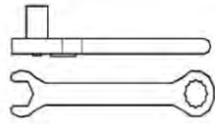

5/16" drill bit
5/8" drill bit

1

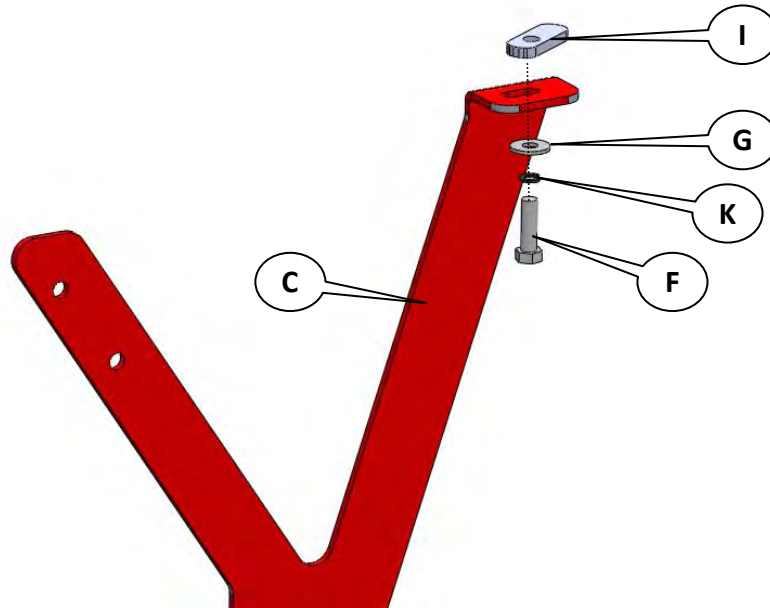

2



3



4

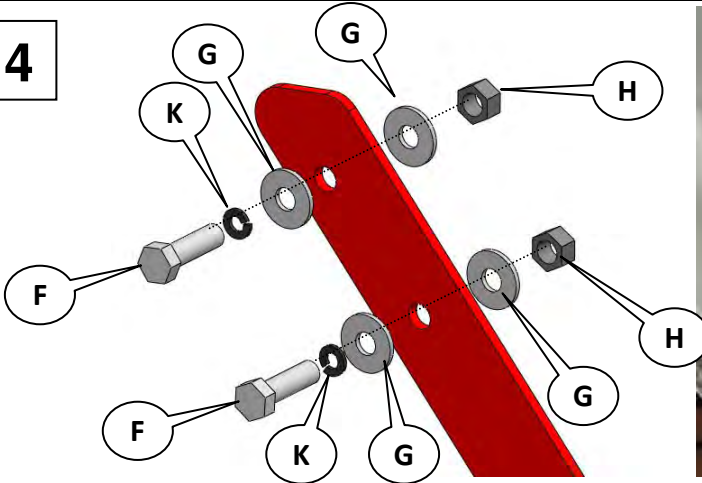

5

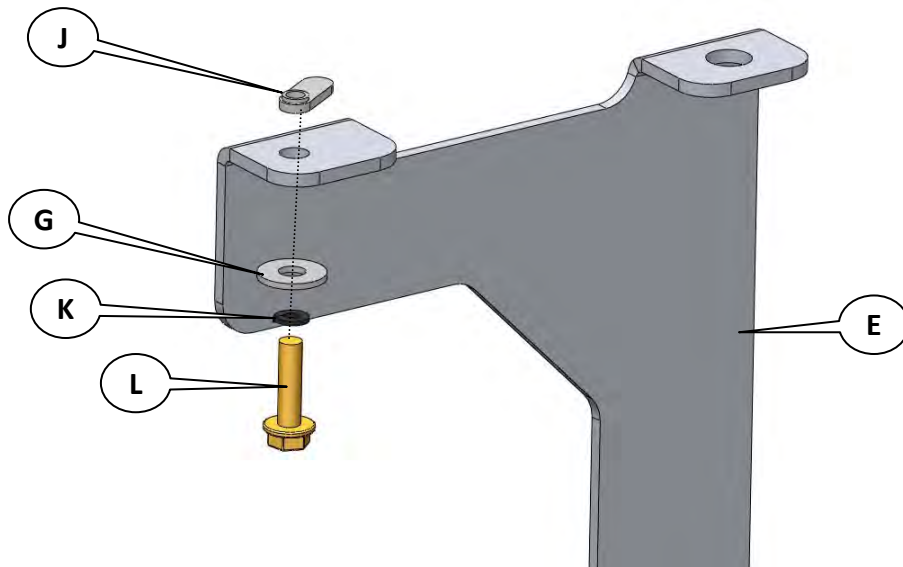

6

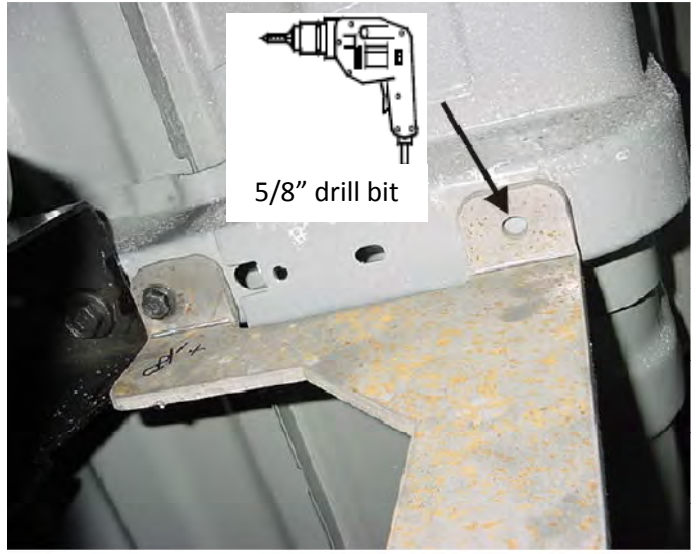

7

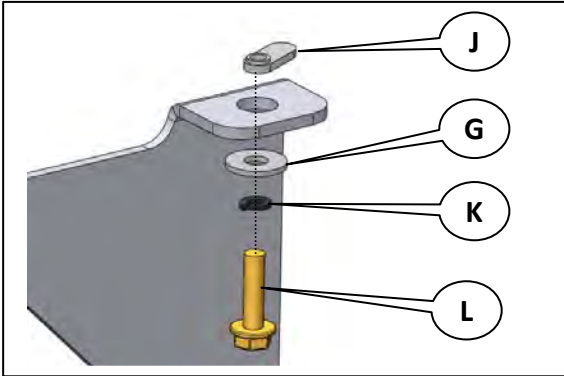

8

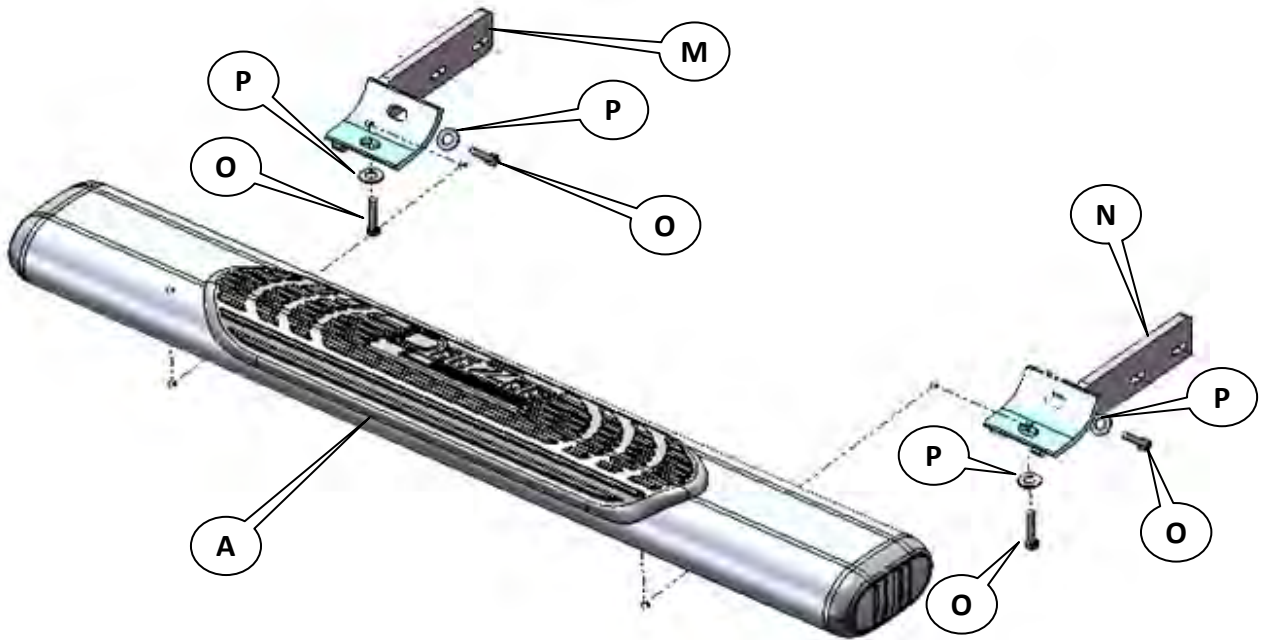

9

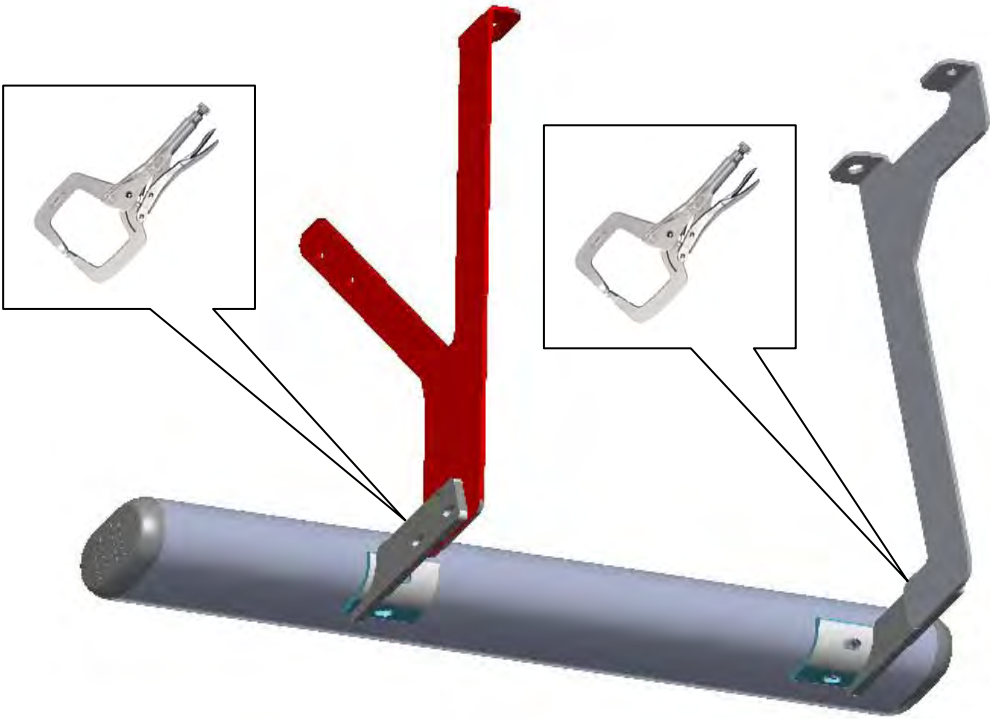

10

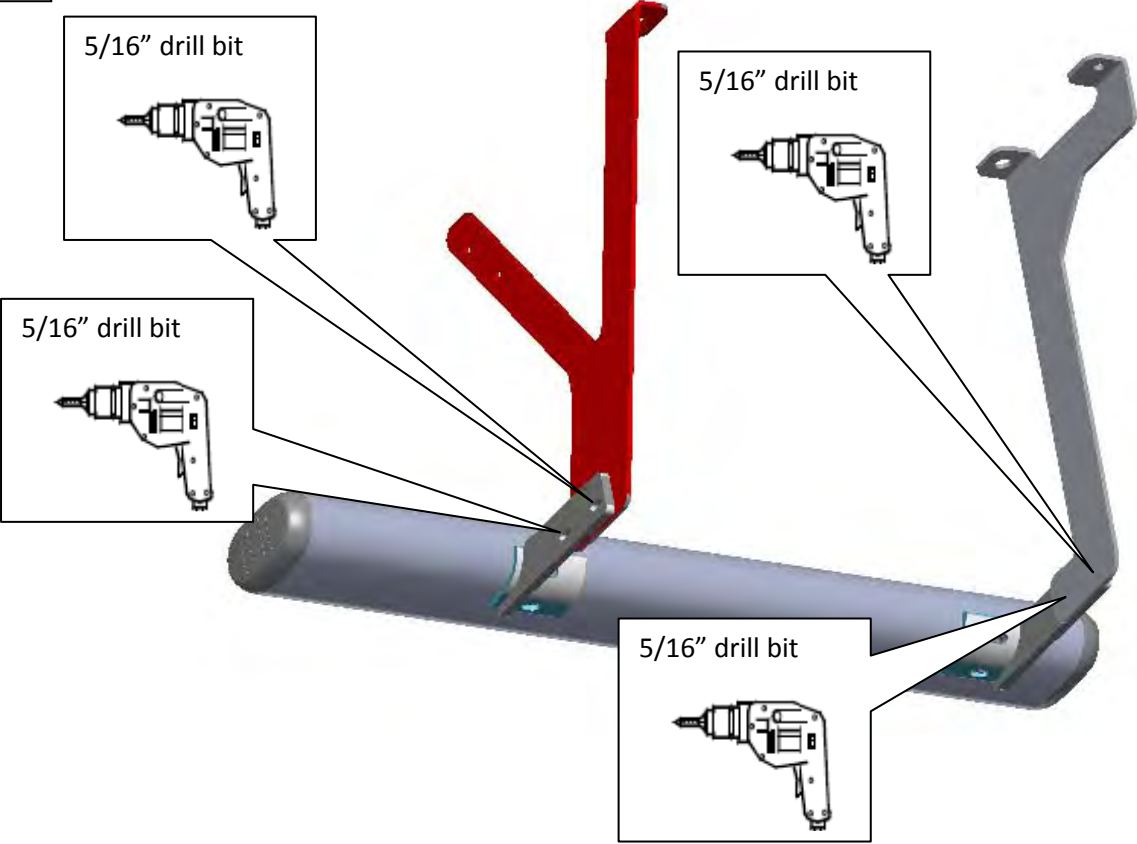

11

