

INSTALLATION INSTRUCTIONS

3" & 4" ROUND AND 4" OVAL SIDEBARS

09-10 DODGE RAM 1500 CREW CAB & QUAD CAB & 2010 RAM 2500/3500 CREW CAB

PART # DZ 372237/DZ 372239

PARTS LIST:

Qty	Description	Qty	Description
1	Driver/Left Sidebar	4	12mm x 40mm Bolt/10mm Nut Plates
1	Passenger/Right Sidebar	2	12mm x 40mm Bolt Plates
1	Driver/Left Front Mounting Bracket	6	12mm x 32mm x 3mm Flat Washers
1	Passenger/Right Front Mounting Bracket	6	12mm Lock Washers
1	Driver/Left Rear Mounting Bracket	6	12mm Hex Nuts
1	Passenger/Right Rear Mounting Bracket	6	11mm Plastic Retainers
4	1/2" x 2" Hex Bolts	4	10-1.50mm x 35mm Hex Bolts
4	1/2" Lock Washers	4	10mm x 27mm x 3mm flat washers
4	1/2" X 1-1/2" OD x 1/8" flat washers	4	10mm Lock Washers

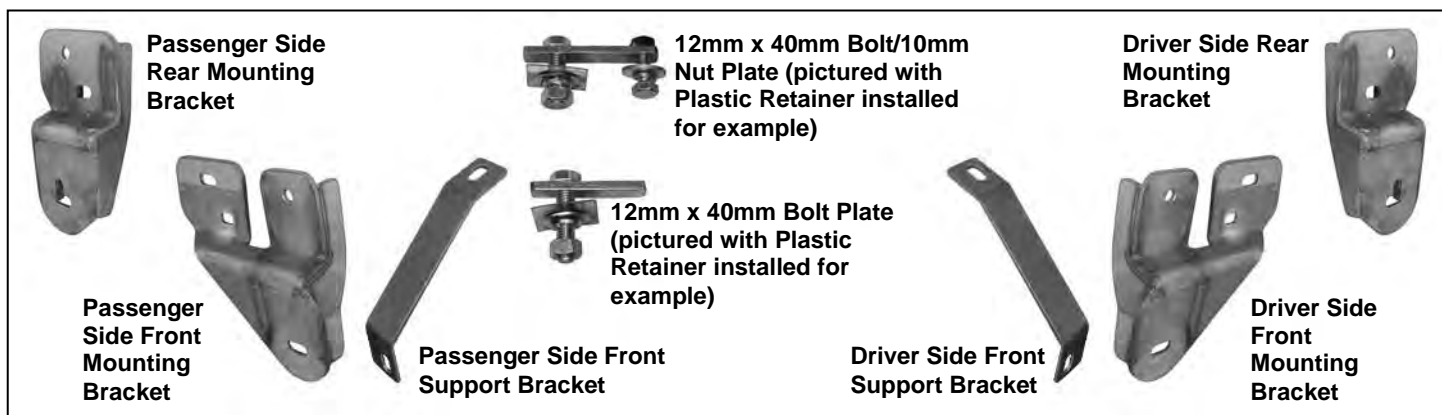

PROCEDURE:

- 1. REMOVE CONTENTS FROM BOX. VERIFY ALL PARTS ARE PRESENT. READ INSTRUCTIONS CAREFULLY BEFORE STARTING INSTALLATION.**
- Starting at the passenger side-front of the vehicle, remove the tape covering the factory oval holes in the passenger side inner panel located by the front tire.
- Next, partially thread a Plastic Retainer onto the threaded end of a Bolt and Nut Plate, **(Fig 1B)**.
- Once you have assembled the Plastic Retainer onto the Bolt and Nut Plate, insert the Bolt and Nut Plate into the factory oval hole. Once the Bolt and Nut Plate is inserted, hold the Bolt end with one hand and tighten the Plastic Retainer with your other hand. **NOTE:** Tighten the Plastic Retainer until it reaches the side panel, **(Figure 2)**.
- Next, select (1) 12mm Bolt Plate and partially thread a Plastic Retainer onto it. Insert the Bolt Plate into the oval hole and install in the forward, smaller oval hole as per step 4, **(Fig 1A)**.
- Select the passenger side front Mounting Bracket. Position the Mounting Bracket onto the installed Bolt Plates. Secure it with (2) 12mm Flat Washers, (2) 12mm Lock Washers and (2) 12mm Hex Nuts, **(Figure 3)**. Do not tighten at this time. Rotate the Bolt and Nut plate until the Nut end lines up with the remaining hole in the Mounting Bracket and body. Thread (1) 10mm x 35mm Hex Bolt, (1) 10mm Flat Washer and (1) 10mm Lock Washer into the threaded nut. Snug but do not tighten hardware at this time.
- Remove the passenger side front factory body bolt. Select the passenger side Front Support Bracket. Insert the factory body bolt through the Support Bracket and up into its original position, **(Figure 3)**. Line the other end of the Support Bracket up with the oval hole in the Front Mounting Bracket. Snug but do not tighten hardware.

8. Moving to the passenger side rear of the vehicle, remove the tape covering the factory oval hole in the inner body panel. Thread a Plastic Retainer onto the threaded end of a Bolt and Nut Plate, (**Figure 1A**). Insert the Bolt and Nut Plate into the factory hole. Once the Bolt and Nut Plate is inserted, hold the Bolt end with one hand and tighten the Plastic Retainer with your other hand, (**Figure 4**). **NOTE:** Tighten the Plastic Retainer until it reaches the side panel.
9. Select the passenger side rear Mounting Bracket. Position the Mounting Bracket onto the installed Bolt and Nut Plate. Secure it with (1) 12mm Flat Washer, (1) 12mm Lock Washer and (1) 12mm Hex Nut, (**Figure 5**). Do not tighten at this time. Rotate the Bolt and Nut plate until the Nut end lines up with the remaining hole in the Mounting Bracket and body. Thread (1) 10mm x 35mm Hex Bolt, (1) 10mm Flat Washer and (1) 10mm Lock Washer into the threaded nut. Snug but do not tighten hardware at this time.
10. Next, select the passenger sidebar and fasten it to the front Mounting Bracket and Support Bracket with the included (1) 1/2" x 2" Hex Head Bolt, (1) 1/2" Lock Washer, and (1) 1/2" Flat Washer (**Figure 6**). Do not tighten at this time. Repeat this step for rear Sidebar mounting.
11. Level and align Sidebar properly; then tighten all hardware at this time.
12. Repeat steps 2-11 for driver Sidebar.
13. Do periodic inspections to the installation to make sure all hardware is secure and tight.

To protect your investment, wax this product after installing. Regular waxing is recommended to add a protective layer over the finish. Do not use any type of polish or wax that may contain abrasives that could damage the finish.

For stainless steel: Aluminum polish may be used to polish small scratches and scuffs on the finish. Mild soap may be used also to clean the Sidebar.

For gloss black finishes: Mild soap may be used to clean the Sidebar.

PASSENGER SIDE INSTALLATION PICTURED

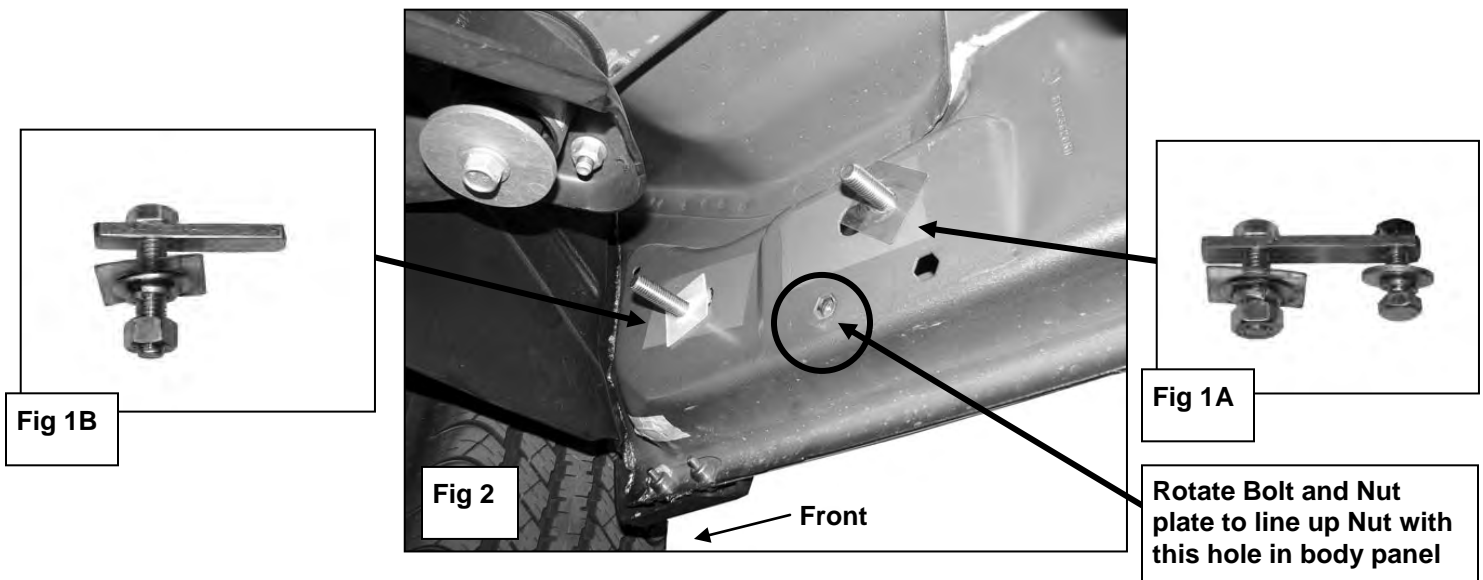

PASSENGER SIDE INSTALLATION PICTURED

