

INSTALLATION SHEET

CLASSIC
PLATINUM & BLACKMAX™

extang
AMERICA'S BEST
SELLING TONNEAUS

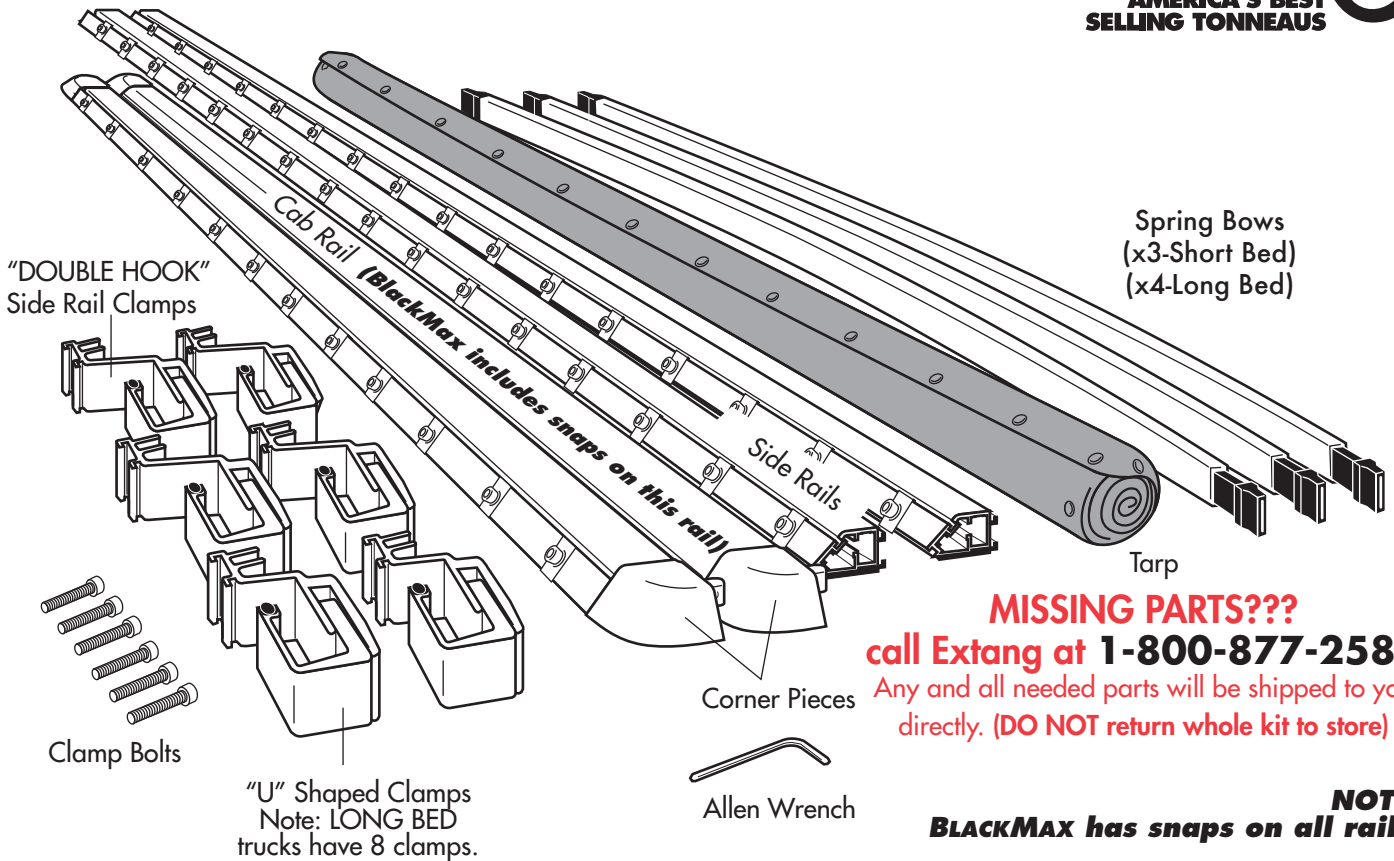

MISSING PARTS???
call Extang at **1-800-877-2588**
Any and all needed parts will be shipped to you directly. (DO NOT return whole kit to store)

NOTE:
BLACKMAX has snaps on all rails.

PARTS INCLUDED IN YOUR KIT. You may want to lay them out in this manner for accessibility.

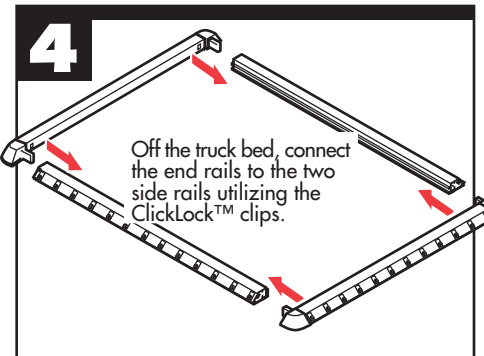
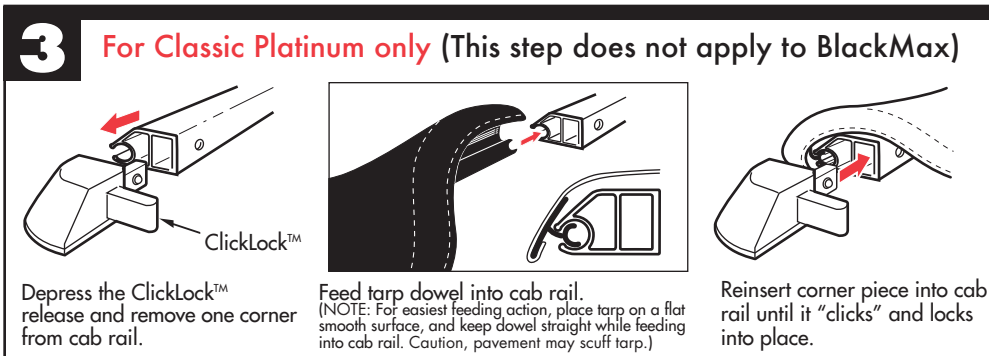

Extang Corporation
5400 S. State Road
Ann Arbor, MI 48108
734 677-0444, Fax: 734 677-8409

0213

Register your warranty at:
extang.com

Item No. 0016-1403 RH Printed in U.S.A.

5

Place the rail assembly over the side of the truck box. Center rails evenly between cab and tailgate.

(NOTE: Some applications have rubber risers (rectangular rubber pads.) A riser must go toward tailgate. Some applications will have a riser at both ends, (most have no riser).

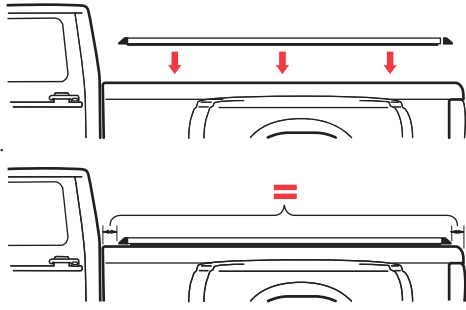

6

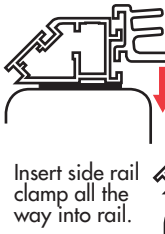

Insert side rail clamp all the way into rail.

Clamp Spacing (Same for each side)
See the stickers located on each side rail for clamp position, or refer to the dimensions given below.
Note: Remove stickers after installation.

Place Clamp Here
STICKER

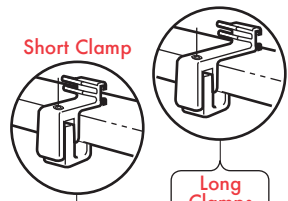
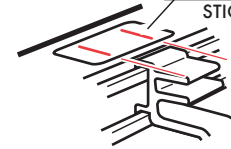

SHORTBED (3 clamps)

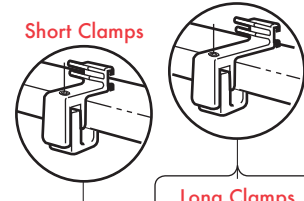

LONGBED (4 clamps)

Longer Clamps

Some trucks use different sizes of clamps to fit curved sidewalls. Longer clamps go in the forwardmost (Cab) positions while the shorter clamps hold the rails at the rear (tailgate) end.

FOR INSTALLATION IN THE FOLLOWING TRUCK MODELS:

- Ford HD Long-Bed
- Ford HD Short-Bed

7

STANDARD CLAMP

IMPORT CLAMP

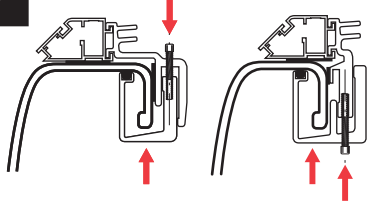

Attach "U" clamp to side rail clamp with allen bolt. Insert side rail clamp all the way into rail.

8

Insert bow onto top or bottom peg.
(Top peg for performance, Bottom for good looks.)

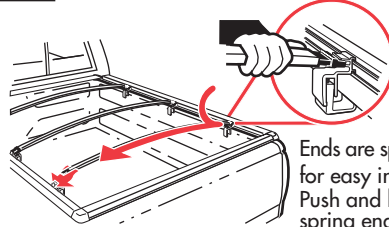

Ends are spring loaded for easy installation. Push and hold on spring end and let the other end slide on with the spring action.



SPECIAL FEATURE: Two pegs offer two height adjustments.



Do Not Place Between the Pegs

9

Start at Corners

Attach tarp by starting at the corners, and snap in place.

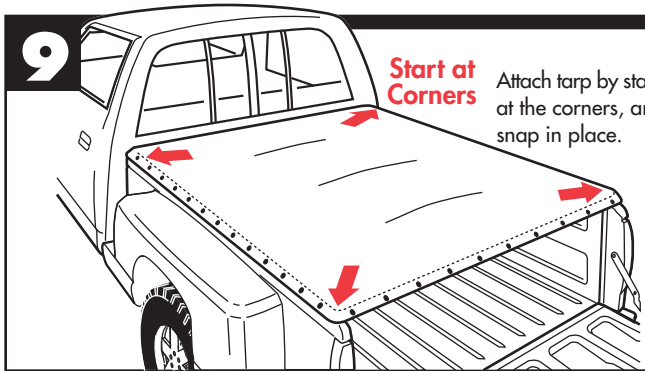

SPECIAL FEATURE Weather-adjustable Snaps

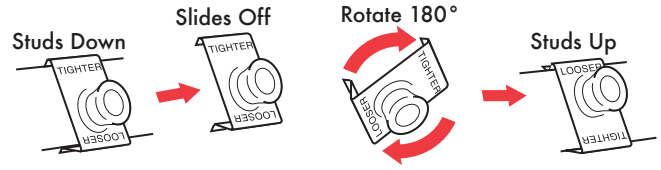

SUMMER SETTING
Takes up slack in tarp caused by warm weather.

WINTER SETTING
Allows more slack in tarp for cold temperatures.

For an OVER-THE-RAIL Bedliner

DIAGRAM A

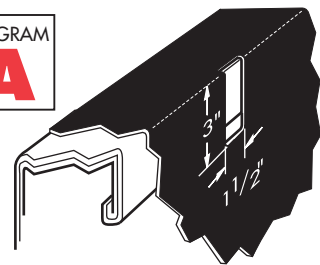
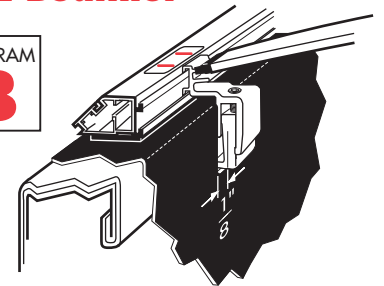

DIAGRAM B



EASY USE OF TRUCK BED

Tarp may be rolled up and secured with Velcro® for bulk hauling

For each clamp mark on your bedliner a 1-1/2" x 3" hole as shown above. Remove clamp. Cut holes in bedliner. Reinsert side rail clamp. Return to step 6.

Side rail clamped to bed with bow attached.



See Part Descriptions on Back

NOTE: To order replacement parts, it's best to contact our Customer Service Department for assistance, to ensure getting the correct part for your vehicle application. When ordering, xxx represents the 3 digit suffix, as referenced on the sales receipt or vehicle application list. Additional parts information can be found on our website, at <http://extang.com/how.html>.

Customer Service: 800-877-2588

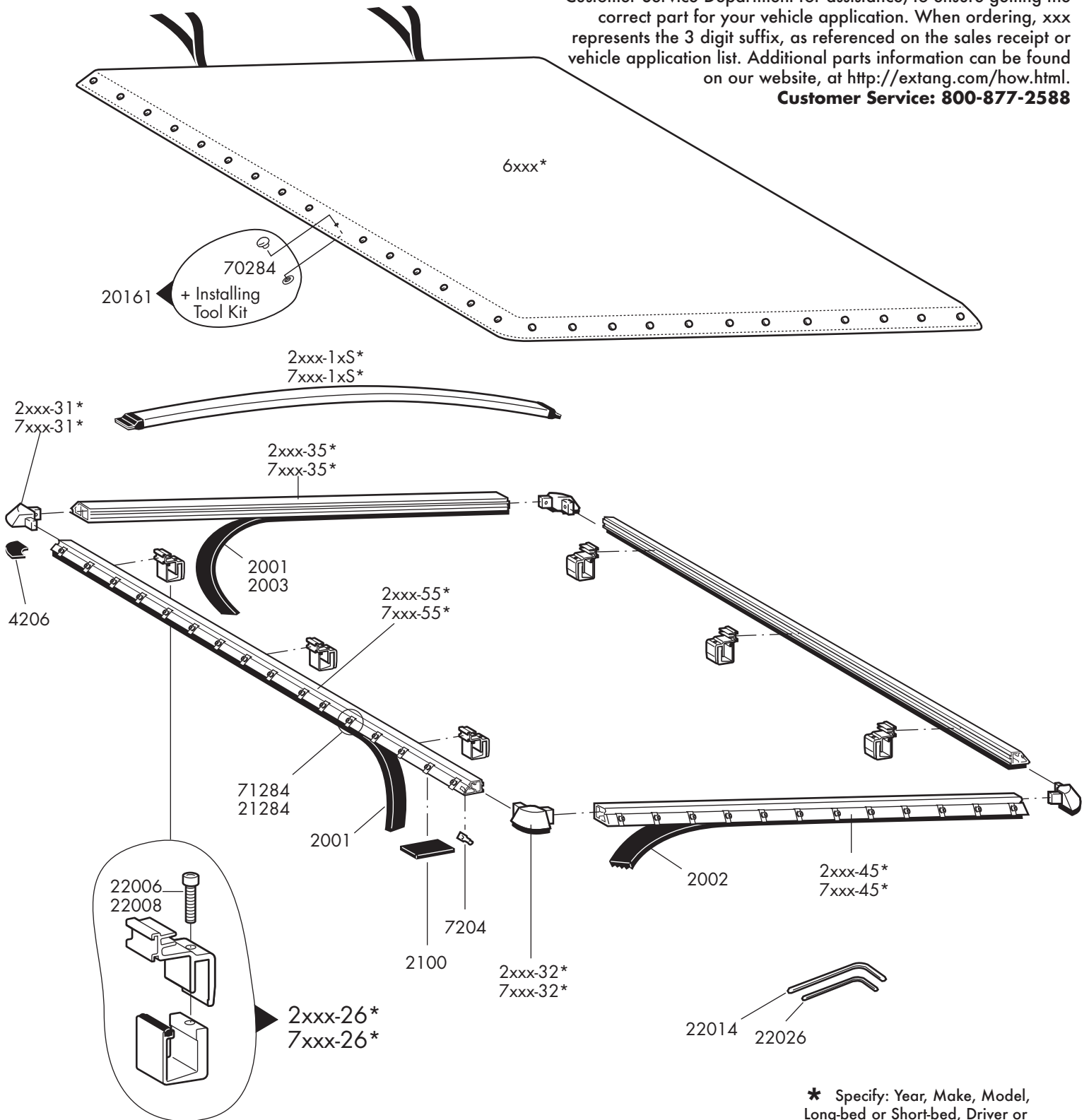

* Specify: Year, Make, Model, Long-bed or Short-bed, Driver or Passenger side.

NOTE: To order, xxx represents the 3-digit application # (vehicle type) following the 1- or 2-digit prefix, as referenced on the vehicle application list or sales receipt. Or call our Customer Service Department at 1-800-877-2588 for assistance.

Classic Platinum

- 6xxx* Black Replacement Tarp
 - 70284 Replacement Tarp Snaps (4)
 - 20161 Tarp Snap Tool Kit (w/4 Tarp Snaps)
- 7xxx-10S* Cab Bow w/Bow Ends (1)
- 7xxx-11S* Center Bow w/Bow Ends (1)
- 7xxx-12S* Cab Center Bow w/Bow Ends (L/B only) (1)
- 7xxx-13S* Tail Center Bow w/Bow Ends (L/B only) (1)
- 7xxx-14S* Tail Bow w/Bow Ends (1)
- 7xxx-26* Double-Hook Clamps (set of 2)
 - 22006 Clamp Bolt 1/4-20 x 1" SHCS (1)
 - 22008 Clamp Bolt 1/4-20 x 1 1/2" SHCS (1)
- 7xxx-31* Front Replacement Corners (2)
- 7xxx-32* Rear Replacement Corners (2)
 - 4206 Replacement Corner Pads (4)
- 7xxx-35* Cab Rail Replacement Assembly
 - 2001 3/16" Black Cab/Side Rail Foam (30' rl.)
 - 2003 3/8" Gray Cab Rail Foam (8' rl.)
- 7xxx-45* Tailgate Rail Replacement Assembly
 - 2002 Tailgate Rail Foam (6' rl.)
- 7xxx-55* Side Rail Replacement Assembly
 - 2001 3/16" Black Cab/Side Rail Foam (30' rl.)
 - 2100 Side Rail Rubber Risers (2)
 - 7204 Snap Stopper (4)
 - 71284 Metal Rail Snaps (4)

BlackMax

- 1xxx* Black Replacement Tarp
 - 1xxx-92* Bright White Replacement Tarp
 - 70284 Replacement Tarp Snaps (4)
 - 20161 Tarp Snap Tool Kit (w/4 Tarp Snaps)
- 2xxx-10S* Cab Bow w/Bow Ends (1)
- 2xxx-11S* Center Bow w/Bow Ends (1)
- 2xxx-12S* Cab Center Bow w/Bow Ends (L/B only) (1)
- 2xxx-13S* Tail Center Bow w/Bow Ends (L/B only) (1)
- 2xxx-14S* Tail Bow w/Bow Ends (1)
- 2xxx-26* Double-Hook Clamps (set of 2)
 - 22006 Clamp Bolt 1/4-20 x 1" SHCS (1)
 - 22008 Clamp Bolt 1/4-20 x 1 1/2" SHCS (1)
- 2xxx-31* Front Replacement Corners (2)
- 2xxx-32* Rear Replacement Corners (2)
 - 4206 Replacement Corner Pads (4)
- 2xxx-35* Cab Rail Replacement Assembly
 - 2001 3/16" Black Cab/Side Rail Foam (30' rl.)
 - 2003 3/8" Gray Cab Rail Foam (30' rl.)
- 2xxx-45* Tailgate Rail Replacement Assembly
 - 2002 Tailgate Rail Foam (6' rl.)
- 2xxx-55* Side Rail Replacement Assembly
 - 2001 3/16" Black Cab/Side Rail Foam (30' rl.)
 - 2100 Side Rail Rubber Risers (2)
 - 7204 Snap Stopper (4)
 - 21284 BlackMax Rail Snaps (4)

Miscellaneous

- 22014** 3/16" Hex Key
- 22026** 3/32" Hex Key

* Specify: Year, Make, Model, Long-bed or Short-bed, Driver or Passenger side.

MAXIMUM STRENGTH WARRANTY

LIFETIME FRAME & 10 YEAR TARP

READ CAREFULLY - KEEP IN A SAFE PLACE

PLEASE ATTACH AND SAVE YOUR SALES RECEIPT.
ACTIVATE YOUR WARRANTY ONLINE AT EXTANG.COM.

Maximum Strength Warranty - Lifetime frame & 10 year tarp
warranty covers the following tonneaus:

CLASSIC
PLATINUM **BLACKMAX™** **FULLTILT™** **TUFF TONNO**

■ **WARRANTY DURATION:**

Lifetime Frame – Extang offers a lifetime warranty against defective materials or workmanship on all tonneau rails, aluminum components, clamps, bows, hardware. **10 Year Tarp** – Extang offers a 10 year warranty against defective materials or workmanship on the vinyl covering.

■ **WARRANTY CONDITIONS:**

This warranty is against defective materials or workmanship. The warranty is void if the product has been damaged by accident, unreasonable use, neglect, improper service/installation/removal, modifications, normal wear and tear or other causes not arising out of defective materials or workmanship. Consequential and incidental damages are not covered under this warranty.

THE FOLLOWING CONDITIONS WILL ALSO VOID THE WARRANTY:

- **Wind whip damage** - Tarps must be secured at all points when vehicle is in motion. An unsecured tarp will flap, resulting in damage to the fabric.
- **Improper cleaning** - It is recommended to use the tested and approved Extang Tonno Tonic™ or clean with soap and water only. Do not use vinyl conditioners (i.e. Armor All®) because they will shrink the vinyl.
- **Overloading of cargo** - Cargo should not touch the tonneau's tarp at any point. Protrusions in the tarp will stress the fabric. Cargo may shift while traveling and cause it to push against the tarp fabric and damage it.

The warranty applies to the original consumer/purchaser. Warranty registration must be on file and/or proof of original purchase (detailed and dated receipt) required for warranty to be effective. Warranty coverage starts from the date of purchase.

■ **PERFORMANCE:**

Provided all warranty conditions are met Extang will either repair or replace (at Extang's option) the product or component. Extang may require the original item to be returned postage prepaid for final determination. Extang reserves the right to substitute and offer the respective warranty discount on an entire replacement system or provide other remedies than those listed in this warranty for discontinued products or other reasons. A return authorization number must be obtained from our customer service department prior to returning any product. Shipping charges will apply for any repair or replacement. This warranty gives you specific legal rights and you may also have other legal rights which vary from state to state.

HELPFUL ACCESSORIES

TONNO TONIC™

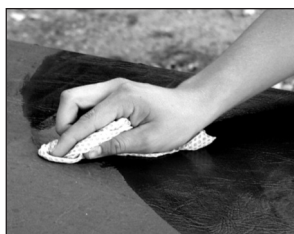

Extang has found through field experience and laboratory tests that most of the popular "vinyl conditioners" actually damage vinyl. After extensive testing, we have developed Tonno Tonic, a product that extends vinyl life and will keep your tonneau looking clean and new.

List Price \$15.95 (16 oz.)



REPLACEMENT PARTS

PRICES SUBJECT TO CHANGE

| | List Price |
|--|-------------------|
| Snaps, Corners, Foam | |
| Sliding Rail Snaps (package of 28) | \$14.25 |
| Sliding Rail Snaps (package of 4) | 2.95 |
| Snap Stopper (set of 4) | 10.95 |
| Corners (2) | 17.55 |
| Tarp Buttons (28) | 14.25 |
| Tool to Attach Tarp Buttons to Tarp with Buttons | 19.95 |
| Tailgate Ribbed Foam (6") | 10.95 |
| Siderail/Cabrail Foam (30' roll) | 10.95 |
| Monster Bows | |
| One Pair of Monster Bow Ends | \$10.95 |
| One Monster Bow with plastic ends | 19.75 |
| Tuff Clamps | |
| Clamps with Bolts (2) | \$19.75 |
| Clamps with bolts (6) | 37.35 |
| Cab Rail Assembly (Rail, Snaps, Foam, Corners) | 35.20 |
| Tail Rail Assembly (Rail, Snaps, Foam, Corners) | 35.20 |
| Side Rail assembly (Rail, Snaps, Foam) | 29.25 |
| Replacement Tonneau Tarp | \$99.00 |

Order today, direct from our customer service department:

1-800-877-2588

5400 S. STATE ROAD, ANN ARBOR, MI 48108
VOICE: **734-677-0444** or **800-877-2588**
FAX: 734-677-8409 EMAIL: info@extang.com
WEB SITE: extang.com



MAXIMUM STRENGTH WARRANTY

LIFETIME FRAME & TARP

READ CAREFULLY - KEEP IN A SAFE PLACE

PLEASE ATTACH AND SAVE YOUR SALES RECEIPT.
ACTIVATE YOUR WARRANTY ONLINE AT EXTANG.COM.

Maximum Strength Warranty - Lifetime frame and tarp warranty covers the following tonneaus: Revolution, Express, Trifecta and eMAX.

■ WARRANTY DURATION:

Lifetime Frame – Extang offers a LIFETIME warranty against defective materials or workmanship on the Revolution, Express, Trifecta and eMAX rails, aluminum components, clamps, bows, hardware. **Lifetime Tarp** – Extang offers a LIFETIME warranty against defective materials or workmanship on the Revolution, Express, Trifecta and eMAX vinyl covering.

■ WARRANTY CONDITIONS:

This warranty is against defective materials or workmanship. The warranty is void if the product has been damaged by accident, unreasonable use, neglect, improper service/installation/removal, modifications, normal wear and tear or other causes not arising out of defective materials or workmanship. Consequential and incidental damages are not covered under this warranty.

THE FOLLOWING CONDITIONS WILL ALSO VOID THE WARRANTY:

- **Wind whip damage** - Tarps must be secured at all points when vehicle is in motion. An unsecured tarp will flap, resulting in damage to the fabric.
- **Improper cleaning** - It is recommended to use the tested and approved Extang Tonno Tonic™ or clean with soap and water only. Do not use vinyl conditioners (i.e. Armor All®) because they will shrink the vinyl.
- **Overloading of cargo** - Cargo should not touch the tonneau's tarp at any point. Protrusions in the tarp will stress the fabric. Cargo may shift while traveling and cause it to push against the tarp fabric and damage it.

The warranty applies to the original consumer/purchaser. Warranty registration must be on file and/or proof of original purchase (detailed and dated receipt) required for warranty to be effective. Warranty coverage starts from the date of purchase.

■ PERFORMANCE:

Provided all warranty conditions are met Extang will either repair or replace (at Extang's option) the product or component. Extang may require the original item to be returned postage prepaid for final determination. Extang reserves the right to substitute and offer the respective warranty discount on an entire replacement system or provide other remedies than those listed in this warranty for discontinued products or other reasons. A return authorization number must be obtained from our customer service department prior to returning any product. Shipping charges will apply for any repair or replacement. This warranty gives you specific legal rights and you may also have other legal rights which vary from state to state.



HELPFUL ACCESSORIES



The MaxSeal Tailgate Seal creates a tight seal along sides and bottom of your tailgate to keep out dust, rain and snow. Quick and easy to install: just cut, peel and stick.



B-Light, Tonneau Lighting System works well with soft and hard tonneau covers. Contains 8 high-intensity LED units. Simple and easy to install and comes with a 1 year warranty.

Order today, direct from our customer service department:

1-800-877-2588

5400 S. STATE ROAD, ANN ARBOR, MI 48108
VOICE: **734-677-0444** or **800-877-2588**
FAX: 734-677-8409 EMAIL: info@extang.com
WEB SITE: extang.com

extang

Item No. 0030-11.13RRE
Printed in U.S.A.

SAVE GAS, YOUR EXTANG TONNEAU MAY PAY FOR ITSELF!

DID YOU KNOW?

**EXTANG TONNEAUS
MAY IMPROVE GAS
MILEAGE UP TO 10%**



HERE'S HOW:

There are conservatively 850,000 Extang Tonneaus on the road everyday and based on the average gas savings, Extang tonneaus save America 102 million gallons of gas per year or approximately \$382,500,000.

Studies show the average truck owner drives 18,000 miles per year. At 15 mpg that comes to 1,200 gallons of gas. At a minimum 10% savings you would save around 120 gallons of gas a year. You can see why it would not take too many months to have your new tonneau pay for itself.

"...adding a tonneau could mean an improvement in fuel mileage that is the equivalent of a free gallon of gas for every 20 gallons used."

- Auto Trim & Restyling News, August 2001

| MILES DRIVEN PER YEAR | MPG | AVERAGE GAS COST | ANNUAL GAS SAVINGS | ANNUAL COST SAVINGS | 3 YEARS COST SAVINGS | 5 YEARS COST SAVINGS | MONTHS FOR TONNO PAY BACK |
|-----------------------|-----|------------------|--------------------|---------------------|----------------------|----------------------|---------------------------|
| 12,000 | 15 | \$3.75 | 80 gal. | \$300 | \$900 | \$1,500 | 12 |
| 15,000 | 15 | \$3.75 | 100 gal. | \$375 | \$1,125 | \$1,875 | 9 |
| 18,000 | 15 | \$3.75 | 120 gal. | \$450 | \$1,350 | \$2,250 | 8 |
| 20,000 | 15 | \$3.75 | 133 gal. | \$498 | \$1,494 | \$2,490 | 7 |
| 22,000 | 15 | \$3.75 | 146 gal. | \$547 | \$1,641 | \$2,735 | 6 |

Results are based on an estimated tonneau price of \$300.00 and rounded to the nearest whole number. Savings may vary and are not guaranteed.

SOMETHING DAMAGED? MISSING PARTS?

CALL US FIRST
800-877-2588

WE CAN HELP YOU QUICKLY AND EASILY OVER THE PHONE



Experienced Customer Service staff
to answer all your tonneau questions

CUSTOMER SERVICE HOURS:
8:30 TO 5 EST, MONDAY - FRIDAY

| | |
|---|-------|
| Tonno Model: | _____ |
| Purchase Date: | _____ |
| Lot Code: | _____ |
| <small>Lot code can be found on underside of cover.</small> | |

extang
AMERICA'S #1
SELLING TONNEAU