



Supercharger Installation Manual

Ford Shelby GT500 Mustang 5.4L 32 Valve

Engine: Ford 5.4L 32 Valve
Mustang Model Years: 2007-2011
FRPP SUPERCHARGER 750 HP KITS

CALIFORNIA AIR RESOURCE BOARD EXECUTIVE ORDER #D-231-33

Table of Contents

Introduction	3
Kit Components	3
Supercharger Oil	3
Recommended Tools	3
Pre-Installation Checklist	4
Supercharger Installation Instructions	5
Illustrated Installation Guide	6
Maintenance and Service	31
Maintenance	31
Servicing Your Supercharger	32
Post-Installation Checklist	33
Checklist Review	33

Symbol Key

Throughout this installation guide you will see the following symbols used:

↻ NOTE

Used to indicate tips and information to aid in installation, maintenance, or use of the supercharger.

!! CAUTION !!

Used to indicate precautions that must be taken to avoid damage to the supercharger and associated components.

⚠ WARNING!!

Used to indicate precautions that must be taken to avoid bodily injury as well as damage to the supercharger and associated components.

Introduction

This supercharger was created for the 5.4L Ford 32 valve engine, model years of 2007-2011. It has been designed and tested specifically for this application. Before beginning installation of this supercharger, first **read this section carefully** then complete the **Pre-Installation Checklist**.

Kit Components

Before beginning installation, be sure you have identified all components of your Whipple FRPP Supercharger Kit. Check the supplied packing slip.

PCM Flash (Complete Kits Only)

Your system includes a FRPP voucher. Follow the voucher instructions to get your flash tool shipped to you. It's important to get this before you start your installation.

Supercharger Oil

As described in the **Illustrated Installation Guide**, the supercharger must be filled with oil prior to use. This supercharger is shipped without oil inside. The oil is in a separate bottle supplied with your kit and you will be instructed to add it in the **Illustrated Installation Guide**.



Warning label attached to Supercharger housing

!! CAUTION !!

Do not attempt to start the engine before adding the supplied Supercharger Oil to the supercharger!

Recommended Tools and Supplies

The following items are not included in this supercharger kit and it is strongly recommended that they're used for ease of installation or maximum performance:

Torque Wrench



You will need a quality torque wrench to ensure proper tightening of bolts.

Tie Straps

These will be useful for securing the wiring harness away from the installation area as directed in the **Illustrated Installation Guide**. They are inexpensive and will be very handy during installation.

Sealants

Blue Loctite™ #242 or equivalent, Red Loctite™ #271 or equivalent. All bolts that need Loctite™ are marked with:

 **Loctite™ (#242 blue) threads** and  **Loctite™ (#271 red) threads**. Thread sealant such as pipe Teflon must be used on all pipe threads.

Chemicals and lubricants

You will need some cleaner/degreaser such as carb cleaner.

You'll be required to fill your intercooler system with approx. 1 gallon of distilled water and Ford approved engine coolant. Red Line Water Wetter is also a great additive, Whipple recommends using 4 bottles during installation. This is not supplied in the system, you can find the coolant and Redline at any local auto parts store.

Motor oil will be useful as a lubricant and should be readily available during installation.

Vacuum

A vacuum is necessary to clean up any debris resulting from grinder use.

Clean Shop Towels

Use these to keep the installation area clean.

Pre-Installation Checklist

Before installing your Whipple Ford Racing Supercharger Kit, complete the following checklist.

!! CAUTION !!

Failure to complete the Pre-Installation Checklist may result in severe engine damage after installation is complete.

1. Verify Condition of Vehicle: Before the supercharger kit is installed, ensure the engine runs smoothly and that the factory malfunction indicator light (MIL) is off. Only install the supercharger kit if the engine runs smoothly *and* the MIL is off.

!! CAUTION !!

This product is intended for use only on stock, unmodified, well-maintained engines. Installation on a worn-out or modified engine is not recommended without factory computer and fuel system modifications. Custom engine configurations could require custom tuning and other supporting modifications.

2. Verify Fuel Octane: Ensure fuel of 91-octane or higher is in the vehicle fuel tank. If the octane grade is not known, drain the fuel tank completely and fill to 1/8th with fuel of 91-octane or higher.

!! CAUTION !!

Use only 91 octane fuel or higher. If fuel of less than 91-octane is present in the vehicle fuel tank, the tank must be completely drained and refilled with 91 or higher octane to 1/8th of a tank.

3. Verify that your fuel level is below a ¼ full. When changing the fuel pump, this will be very important. If fuel level is above a 1/4 tank, then you will be required to drain fuel until you reach a ¼ tank or less.
4. Assess Cleanliness of Installation Area: Make sure your work area and the underhood area are free from debris. This supercharger is a high-quality, close-tolerance compressor and must not be subjected to contamination by dirt or any type of foreign material. If necessary, vacuum around engine to remove any foreign material.

!! CAUTION !!

DO NOT remove the protective seal on the supercharger prior to installation. Foreign material entering the supercharger will automatically void all warranties.

5. Identify Supercharger Kit Components: Before beginning installation, identify all the components of your Whipple Supercharger Kit and ensure all items are present and undamaged.
6. Read Illustrated Installation Guide: Be sure to read through the **Illustrated Installation Guide** starting on page 6 *before* beginning supercharger installation. Familiarize yourself with the components and tools you will use and the procedures before you start for faster and easier installation.

Supercharger Installation Instructions

Vehicle: 07-11 Shelby GT500

Engine: 5.4L 32V

Before you begin installing the Whipple Ford Racing 5.4L 32V Supercharger, make sure you have completed the **Pre-Installation Checklist**. Be sure you have:

1. Verified the Condition of the Vehicle
2. Verified the Fuel Octane
3. Verified that the fuel level is below a ¼ tank (**complete kits only**)
4. Assessed the Cleanliness of the Installation Area
5. Identified the Supercharger Kit Components
6. Read and Understood the Illustrated Installation Guide

Have you completed all items in the **Pre-Installation Checklist**?

➔ NOTE

****NOTICE:** Installation of Whipple Supercharger products signifies that you have read this document and have agreed to the terms stated within.

It's the purchaser's responsibility to follow all installation instruction guidelines and safety procedures supplied with the product as it's received by the purchaser to determine the compatibility of the product with the vehicle or the device the purchaser intends to install the product on.

Whipple Superchargers assumes no responsibility for damages occurring from accident, misuse, abuse, improper installation, improper operation, lack of reasonable care or all previously stated reasons resulting from incompatibility with other manufacturer's products.

There are no warranties expressed or implied for engine failure or damage to the vehicle in any way, loss of use or inconvenience or labor reimbursement. This includes merchantability and fitness.

 **NEVER SMOKE DURING THE INSTALLATION OF THE SC, THERE WILL BE FLAMMABLE FUMES AND LIQUID AROUND THE VEHICLE**

Be sure you have read and understand the **Introduction** section and have completed the **Pre-Installation Checklist**, then proceed to the **Illustrated Installation Guide**.

Illustrated Installation Guide

It is strongly recommended that you read through this guide before you begin installing the Whipple Supercharger.

1. Using an air hose, blow off any loose dirt or debris from engine compartment. If really dirty, then steam clean the engine compartment before proceeding to the next step.
2. Release fuel system pressure.

2011 . fuel pump relay



2010 fuel pump relay



- The fuel pump relay can be found in the bussed electrical center located on the passenger side, front of engine compartment fuse panel. The fuel pump relay is located in position 21 as shown in the inside cover of the bussed electrical center. Remove the fuel pump relay. (2011 bused electrical center has changed see inside cover for fuel pump relay position)
- Start the engine and allow it to idle until it stalls. If engine does not start, proceed to next step.
- After the engine stalls, crank the engine for approximately 5 seconds to make sure the fuel injection supply manifold pressure has been released.
- Turn the ignition switch to the OFF position.

⚠ WARNING!! Batteries normally produce explosive gases. Therefore, do not allow flames, sparks or lighted substances to come near the battery. When charging or working near a battery, always shield your face and protect your eyes. Always provide ventilation. Failure to follow these instructions may result in personal injury.

⚠ WARNING!! Keep out of the reach of children. Batteries contain sulfuric acid. Avoid contact with skin, eyes or clothing. Also, shield your eyes when working near the battery to protect against possible splashing of the acid solution. In case of acid contact with the skin or eyes, flush immediately with water for a minimum of 15 minutes and get prompt medical attention. If acid is swallowed, call a physician immediately. Failure to follow these instructions may result in personal injury.

3. Disconnect ground cable from battery using an 8mm wrench.
4. Disconnect power cable from battery using an 8mm wrench.
5. Remove battery strap and remove battery from vehicle.
6. Remove battery tray from vehicle.
7. Disconnect the following factory electrical connectors:
 - Mass Air Flow Sensor element. Carefully pull red tab out, squeeze the connector and then pull the connector away from connection.

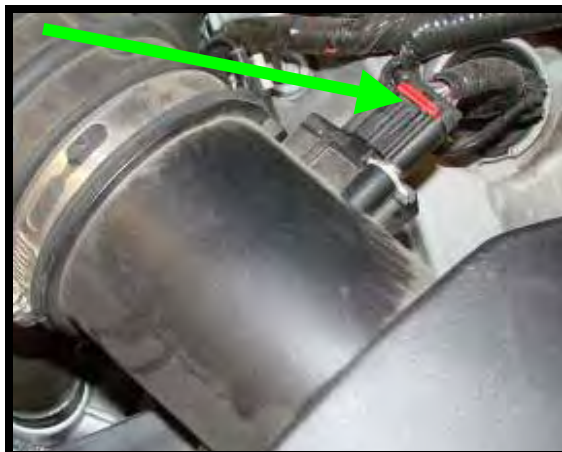

- ❑ Electronic Throttle Control motor. Carefully pull red tab out, squeeze the connector and then pull the connector away from connection.

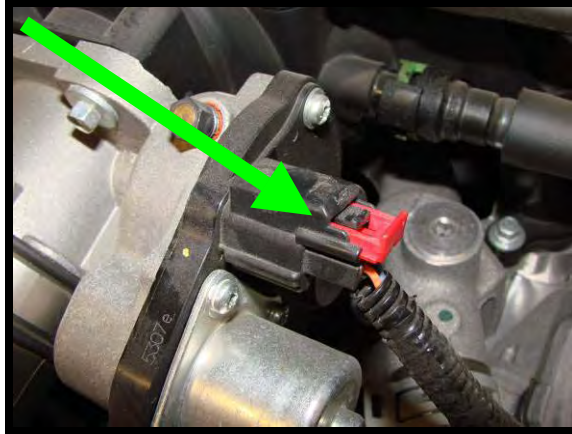

- ❑ Throttle Position Sensor. Carefully pull red tab out, squeeze the connector and then pull the connector away from connection.

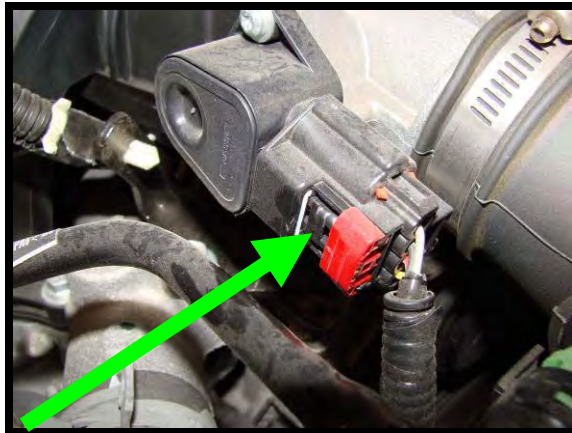

8. Disconnect plastic breather hose from passenger side valve cover to factory supercharger inlet. To release, push green tab on bottom side and then pull.

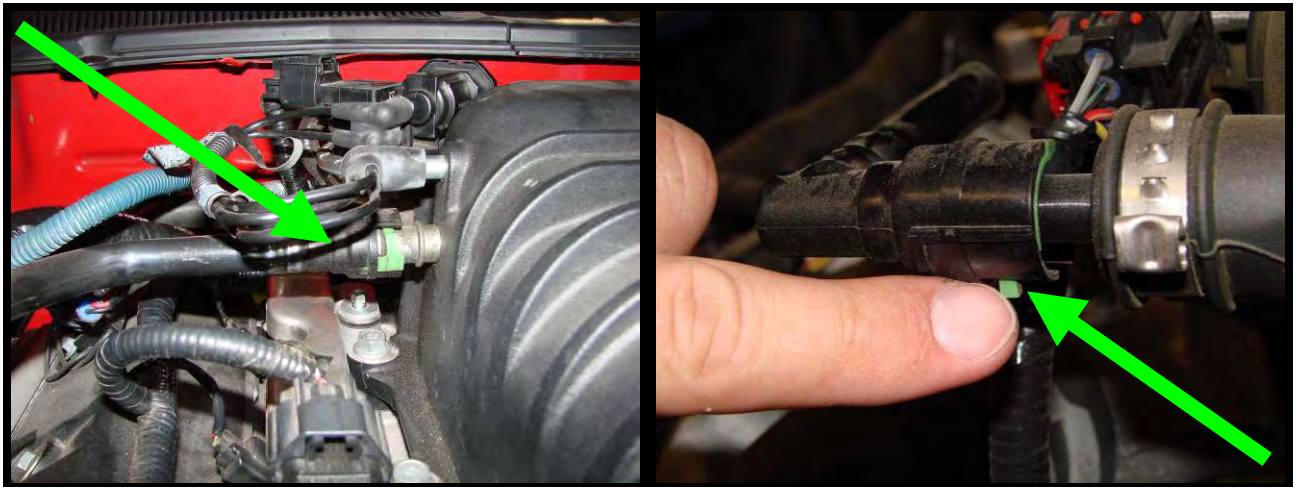

Installation Manual: GT500 FRPP Supercharger System (750HP) (A1R2)

Last Updated: Aug 2nd, 2010

9. Disconnect rubber 90deg fitting from air intake tube (Ford #7R3V 9E498 BB). This will not be used later. Will be removed from bypass nipple when SC is off.



10. Disconnect plastic PCV hose fitting from driver side of intake manifold. To release, push green tab on bottom side and then pull.



11. Remove the hose clamp securing the rubber inlet hose to throttle body and air box.
12. Remove plastic air inlet between MAF and throttle body.
13. Remove air box from vehicle.
14. Disconnect and remove EGR steel tube from EGR solenoid and exhaust manifold.

15. Disconnect rubber line from fuel PSI sensor.

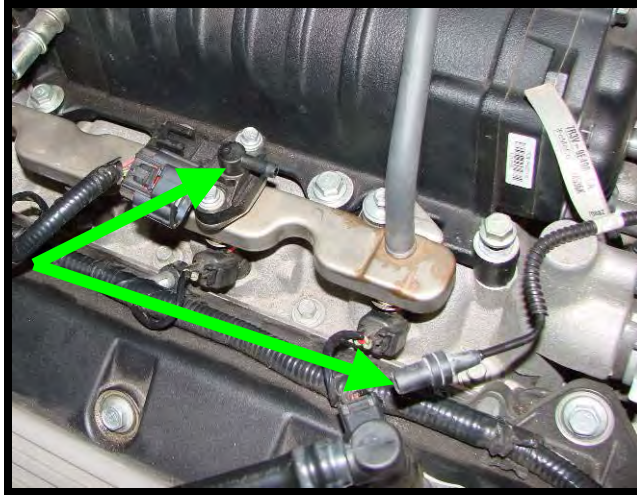

16. Disconnect electrical connector from fuel PSI sensor. Carefully pull red tab out, squeeze the connector and then pull the connector away from connection.

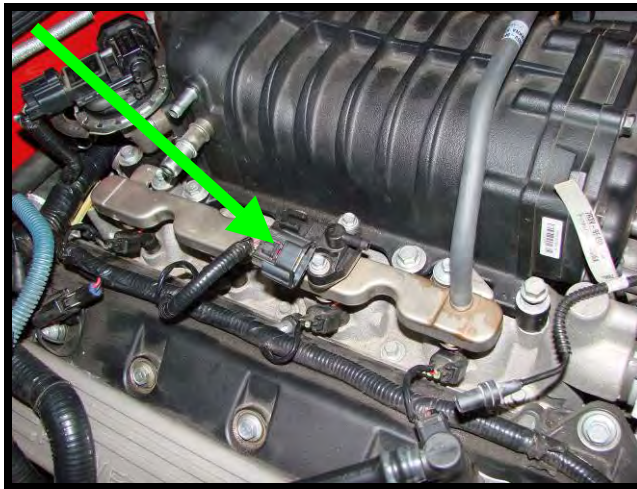

17. Disconnect the 3/8" ID rubber hose from rear/center of supercharger.

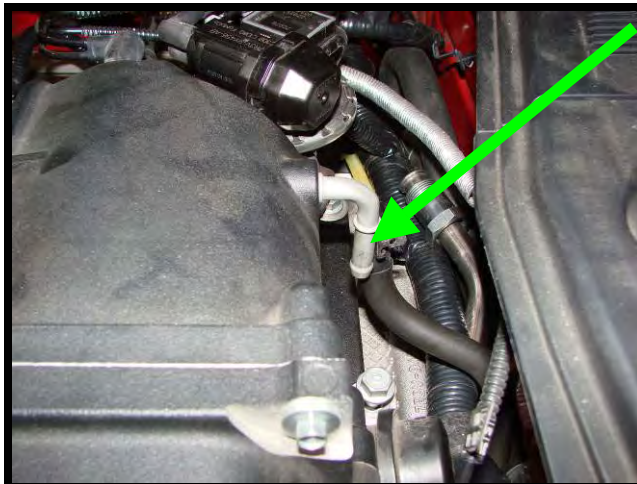

18. Disconnect the rubber line coming from the brake booster to the rear SC intake. To release, squeeze the clear plastic portion of the connector and pull.

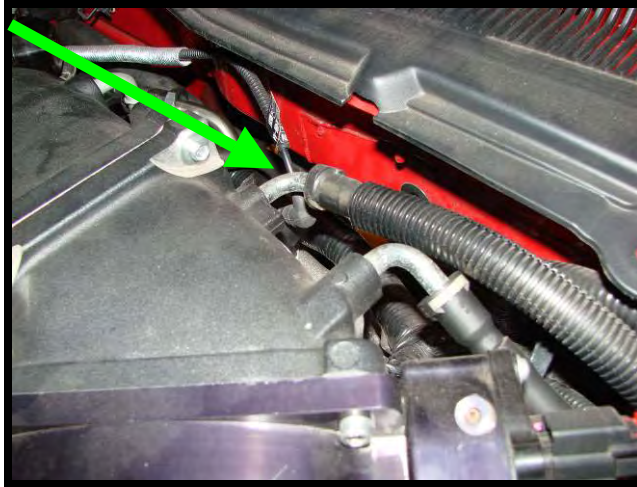

19. Disconnect the rubber line coming from box located on driver side inner fender to the rear/driver side of SC intake. To release, squeeze the clear plastic portion of the connector and pull.

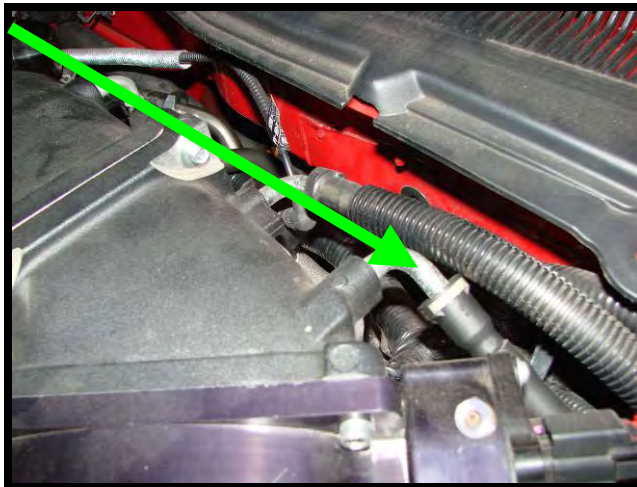

20. Disconnect the factory fuel line from fuel rail. To release, squeeze the clear plastic portion of the connector and pull.

Installation Manual: GT500 FRPP Supercharger System (750HP) (A1R2)

Last Updated: Aug 2nd, 2010

21. Disconnect the IAT2 temp sensor (manifold air temp sensor).

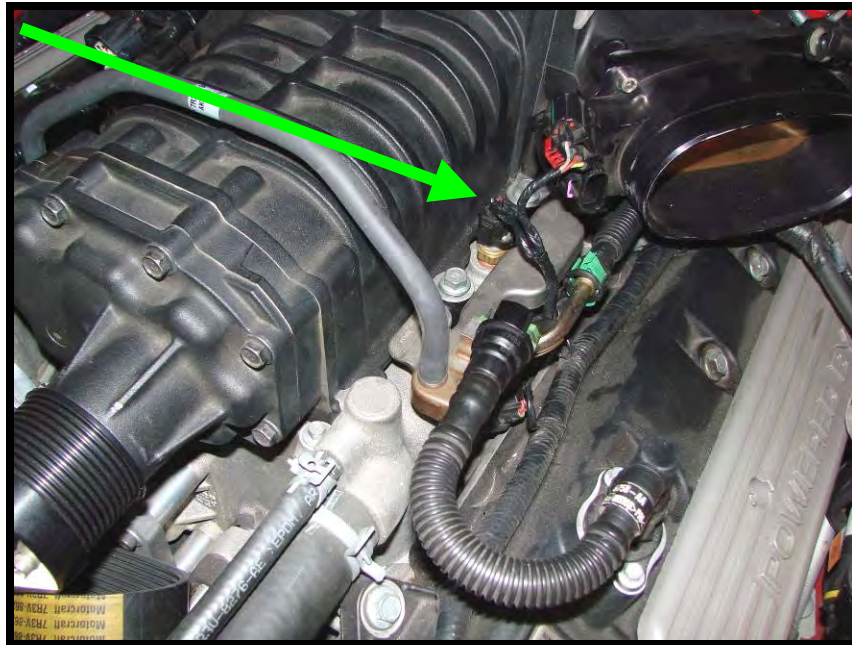

22. Remove the (2) bolts (6mm socket) holding the coolant reservoir on. Let the reservoir hang, this will give better access to the spring loaded tensioner.

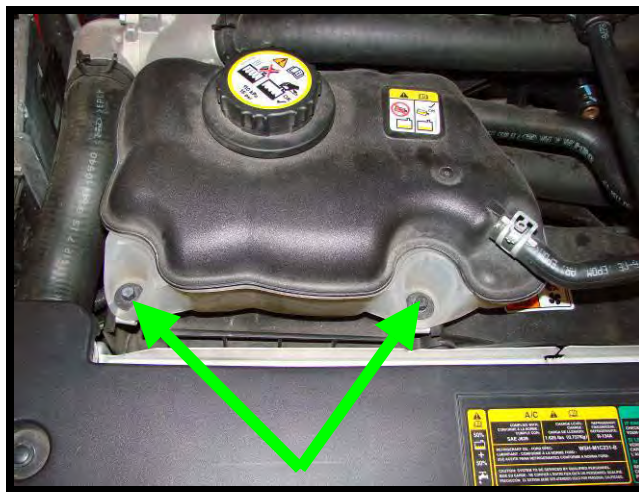

23. Remove the throttle body from SC inlet by removing the (4) bolts (8mm socket).

24. Remove the SC inlet from SC by removing the (4) bolts (8mm socket).



25. Remove the fuel rail from manifold by removing the (4) bolts (8mm socket).
26. Remove 10-rib SC belt from motor by using a 3/8" breaker bar or ratchet. Install breaker bar/ratchet into spring loaded tensioner and rotate in a clockwise rotation, remove belt from SC pulley. Let spring loaded tensioner return to relaxed position.
27. Remove (1) line from 90deg rubber boot that goes to air bypass nipple. This is the long 1/8" tube with the 90deg on the end that is routed to factory bypass valve.



28. Remove the SC from manifold by removing the (10) bolts (13mm socket).

Installation Manual: GT500 FRPP Supercharger System (750HP) (A1R2)

Last Updated: Aug 2nd, 2010

29. Remove the factory ground from driver side firewall and leave loose for now.



30. Install the supplied 3/8" plastic barb to the factory 3/8" hose. Install supplied 3/8" x 4" hose to plastic barb, route to the driver side by brake booster for later installation. Secure barb with (1) factory clamp and (1) supplied pinch clamp.



31. 2011 models only Substitute the harness with the supplied P clip and wrap the wires by the EGR tube with silver insulation.



32. DO NOT INSTALL DOW PINS, they are not needed for proper installation.
33. Preinstall (1) of the supplied 8mm x 25mm 6-point bolts so 12-15mm of thread/bolt is exposed in the further most/driver side bolt hole in intake manifold. You will not be able to install this after this point. All other bolts can be reached after SC install.



34. 2011 models only In some applications, the bypass actuator may need to be adjusted, to adjust loosen the 2 button head allen bolts and move away from firewall. Actuator needs a light amount of preload into the actuator. Re-tighten button head allen bolts torque to 20 ft/lbs.
35. 2011 models only In some applications , the SC system will hit the firewall. In this case, you will need to slide the engine forward. Loosen all bolts for the front suspension K-member and transmission. Slide forward, check the SC clearance. Once install is done the vehicle needs to be aligned.
36. 2011 models only Remove steel harness wire protector at the rear since it will not clear the motor. Locate the EGR wiring harness, pull from plastic loom so the wires have more access to the new location of EGR valve.
37. Apply approximately a 3mm bead of Black RTV silicone on top of factory oring (entire oring) to help prevent leaks between the manifold and the supercharger.
38. Install supercharger assembly by sliding adapter plate and SC assembly on. The rear holes are slotted to help guide the SC assembly into position. Make sure the rear 3/8" hose does not get pushed down, this needs to be pushed onto the back of the supercharger inlet.
39. Install the other supplied (1) 8mm x 25mm 6-point bolt (10mm socket) into rear/passenger side bolt hole, do not tighten yet.
40. Install the other supplied (8) 8mm x 30mm 6-point bolts (10mm socket). Tighten the (8) 8mm x 30mm 6-point bolts hand tight.

Installation Manual: GT500 FRPP Supercharger System (750HP) (A1R2)

Last Updated: Aug 2nd, 2010

41. Using a 10mm ratchet wrench, tighten the (1) 8mm x 25mm 6-point bolt you previously installed (under the inlet system/driver side). Get this snug, but not tight yet.
42. Follow the following torque sequence (3-8-2-7-4-9-1-6-5-10), first pass 18 ft/lbs, second pass 25 ft/lbs. Improvise for the 1 bolt that you must use the 10mm ratchet wrench. This must be similar to 25 ft/lbs.

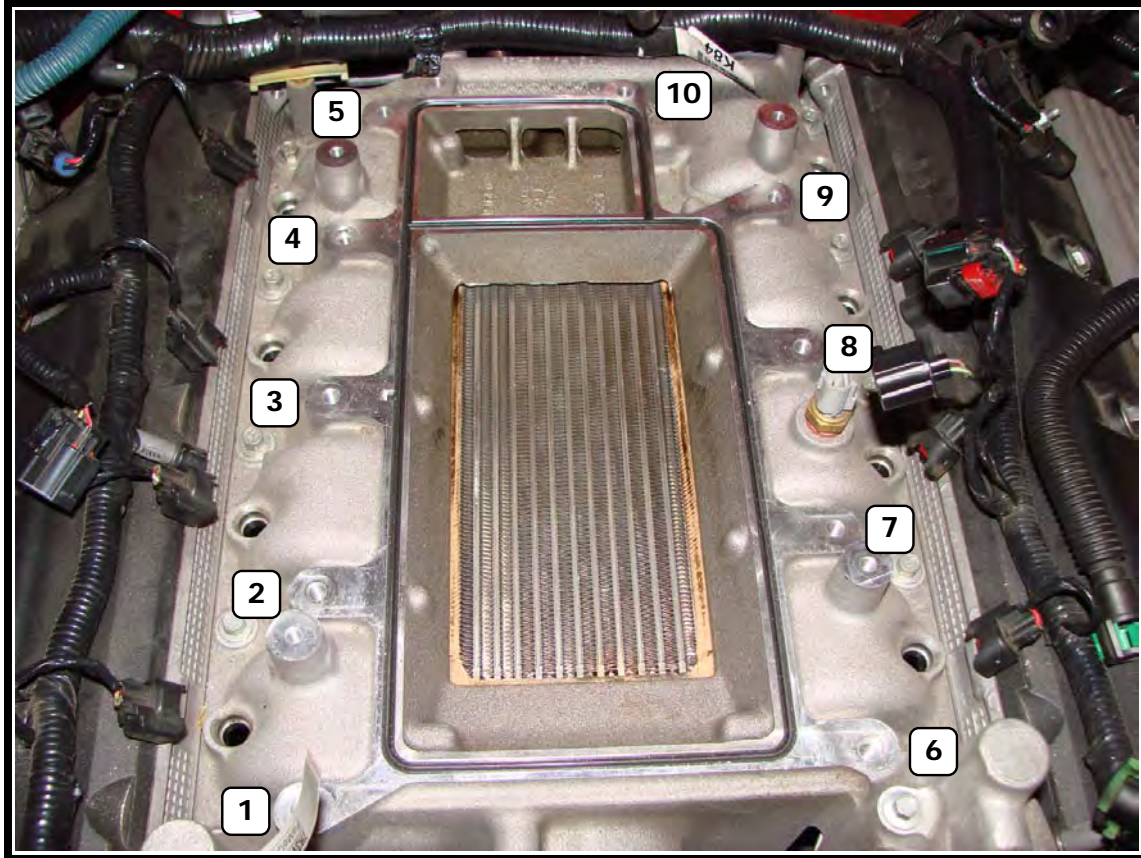

43. Install driver side fuel rail. To do this, remove all (4) of the fuel injectors. Apply grease to orings. Carefully place 1 injector in the back cylinder (let it lie in the injector boss, but do not push down yet. Route fuel rail under inlet. To get fuel injector in, tilt rail counter clockwise and the injector clockwise at the same time until you get injector oring started in the rail, then rotate the rail back in the clockwise rotation and push the injector into the rail. **Once the rear injector is installed, reinstall the safety clip to secure injector in place.** Reinstall the safety clip to secure injector. Now install the following (3) injectors and safety clips, then press into manifold injector bosses. Make sure injectors are pressed into rail and manifold all the way.
44. Secure driver side rail with (1) 6mm x 15mm hex head bolt with 6mm AN washer for the back boss, under the SC inlet. Utilize the supplied 6mm x 20mm socket head cap screw and 6mm allen to front bolt boss. Torque to 110 in/lbs.
45. Install passenger side fuel rail to manifold, secure with the factory 6mm bolts. Torque to 110 in/lbs.

Installation Manual: GT500 FRPP Supercharger System (750HP) (A1R2)

Last Updated: Aug 2nd, 2010

46. Apply light amount of black RTV silicone to EGR adapter surface. Install EGR billet adapter on SC using supplied (2) 6mm x 25mm socket head cap screws and torque to 89 in/lbs. **(2011)** Adjust the orientation of the EGR adaptor to ensure that the bolt clearance grooves are in the upward position.
47. Install new EGR tube to exhaust manifold and EGR. Leave loose for next instruction.
48. Install EGR to SC inlet using the supplied (2) 8mm x 20mm 6-point bolts. Tighten to 20 ft/lbs.
49. Tighten both ends of the EGR tube (at exhaust manifold and billet adapter).
50. Connect EGR electrical connector to EGR solenoid until it locks in place.



51. Install supplied plastic plug into 90deg rubber boot open hole (line pulled out that use to route to bypass valve).
52. Connect rubber/plastic lines to EGR solenoid and connect rubber 90deg boot to Whipple billet adapter.

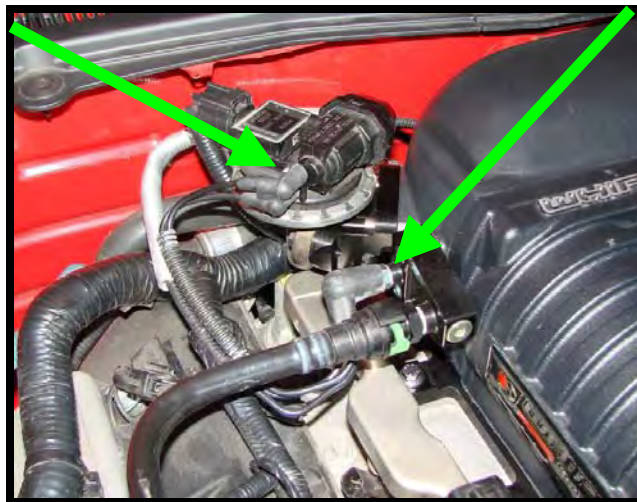

53. Connect EVAP line to quick connect fitting on passenger side intake.



54. Connect all 8 fuel injector connectors until they snap/lock in place.
55. Connect fuel psi sensor connector until it snap/locks in place.
56. Connect fuel PSI pressure hose from intake manifold back to sensor barb.

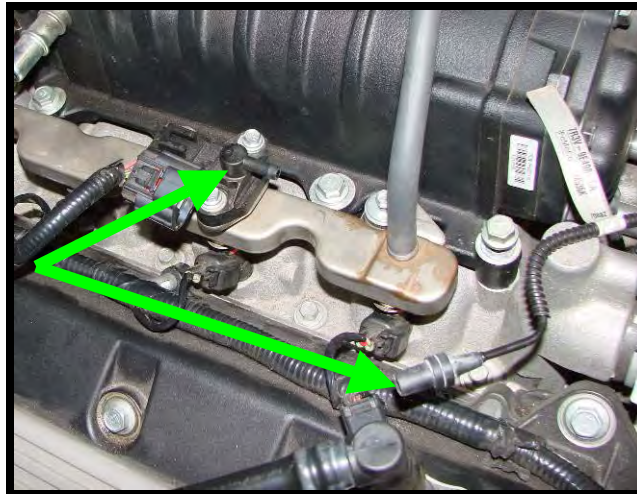

57. Connect rubber 3/8" line to SC inlet barb fitting you previously installed, secure with pinch clamp.

58. Locate rubber line coming from brake booster, route back towards driver side so hose makes complete U shape, then route to SC inlet. Connect the quick connect fitting from the brake booster to SC inlet quick connect male fitting (bottom). Make sure it snaps/locks in place.

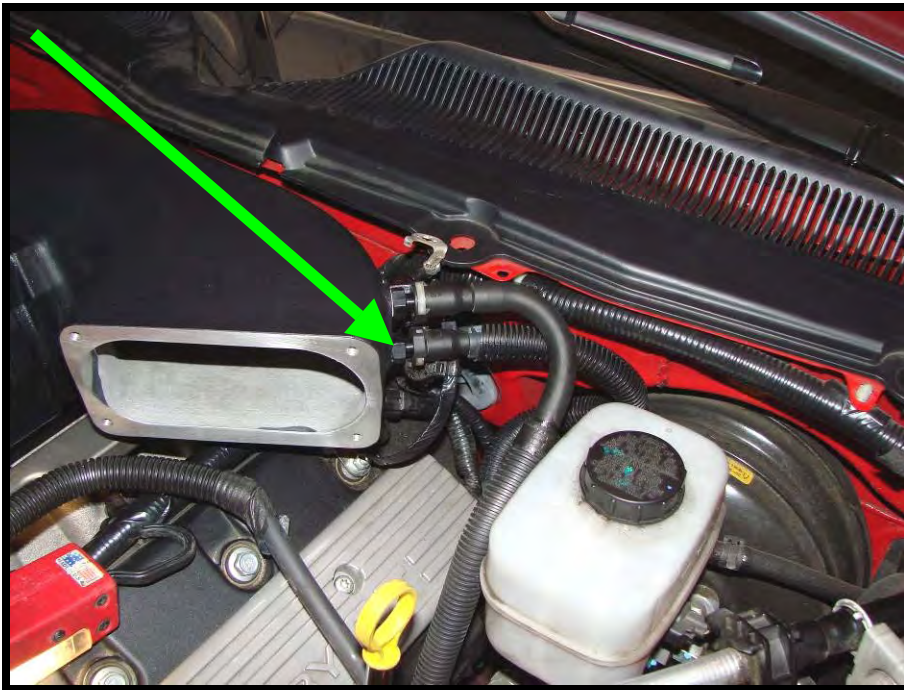

59. BVES valve instructions 2011 only

- Remove BVES valve from stock supercharger inlet.
- Slip valve into adapter then slip assembly into bracket bolt together with factory bolts.



- Install the bracket for the BVES valve by mounting it on the two bosses on the front of the driver's side head with (2) 8x16 low head allen bolts supplied.



- Lengthen the harness for the BVES valve with provided green & white wire. Cut solder & heatshrink the splices then cover with conduit.



- Connect the wiring takeout for the BVES valve. Have the takeout follow the cam sensor wiring loom along the intake/head mating area.
- Cut hard line as shown and splice together with billet adapter and clamps.



- Connect the BVES valve hard line to the aluminum chassis tube.



- Connect the supplied hose from the nipple on the adapter housing to the nipple on the blower intake housing.
- Keep all hoses away from the exhaust manifold.

60. Connect the quick connect fitting from the box located on the driver side inner fender to SC inlet quick connect male fitting (top). Make sure it snaps/locks in place.

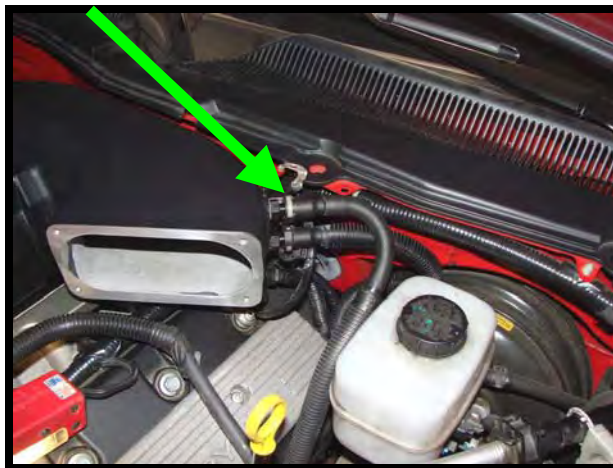

61. Reinstall the factory ground from driver side firewall and leave loose for now.



62. Connect the factory fuel line until it snaps/locks in place.
63. Remove the coil covers on the valve covers by removing (4) torx bolts (T30).
64. Remove the (8) ignition coils from engine. Remove the (8) mounting bolts (7mm socket). Pull coil packs up and out.
65. Remove the (8) spark plugs from engine (5/8 spark plug socket).
66. Gap supplied spark plugs to .025".
67. Install the new supplied spark plugs (5/8" spark plug socket) and torque to 25 ft/lbs.
68. Reinstall the (8) ignition coils and (8) 6mm mounting bolts (7mm socket), torque to 53 in/lbs.
69. Reconnect the (8) ignition coil electrical connectors, push until they click and lock in place.
70. Install supercharger belt, follow the matrix for proper belt selection:

W175AX PULLEY AND BELT MATRIX WITH STOCK CRANK PULLEY

SC Pulley	Belt length
2.500	Stock (84.0") with idler
2.625	Stock (84.0") with idler
2.750	Stock (84.0") with idler
2.875	Stock (84.0") with idler
3.000	Stock (84.0") with idler
3.125	Stock (84.0")
3.250	Stock (84.0")
3.385	Stock (84.0")

71. Apply 2mm bead of black RTV silicone to supercharger inlet to throttle body flange. Install the supplied billet throttle body to the supercharger intake. Secure with the factory fasteners, (4) 6mm bolts (8mm socket). Torque to 89 in/lbs.
72. Remove MAF element from factory airbox by removing the 2 torx bolts (T20 torx).
73. Install MAF element into new 123mm MAF housing using the supplied 5mm x 7mm socket head cap screw (3mm allen wrench), torque to 58 in/lbs.  **Loctite™ (#242 blue) threads.**



74. (2007-2009 Models only) install block off plate in SVT airbox place provided plate over hole in side of airbox drill holes and bolt in with button head bolts provided.



75. Install supplied SVT airbox with 123mm MAF housing into factory location. Secure with factory fasteners. allen wrench), torque to 100 in/lbs.  **Loctite™ (#271 red) threads.**



76. Reconnect the MAF connector to the MAF element.

- Install the supplied hump hose to the factory throttle body and secure to throttle body using the supplied (1) #72 hose clamp (5/16" nut driver).
- Install the supplied 4" silicone hose over the plastic inlet duct as well as the (2) supplied #64 hose clamps. Slide the silicone hose as far up as possible for easier installation of the plastic air inlet ducting.
- Install the oval end of the plastic air inlet duct to the throttle body/hump hose and lift up, install the vent hose to the 3/8" plastic barb. Line up the plastic duct with the MAF housing. Secure the hump hose side with the supplied (1) #72 hose clamp (5/16" nut driver) Secure the MAF to plastic duct hose with the supplied (2) #64 hose clamps (5/16"nut driver).

77. Reinstall coolant reservoir with factory hardware.

78. Fill the new s/c compressor with oil per supplied instructions.

!! CAUTION !!

Severe damage to the compressor will occur if you overfill the supercharger front gear case.

- Make sure the SC is sitting square/flat.
- Remove -4AN allen plug (3/16" allen wrench) and fill SC with **WHIPPLE SC OR FORD #XL-4 OIL ONLY!!**
- Fill to the middle of the sight glass. NOTE: The W175AX compressor takes a maximum of 5.8 fl/oz. and the W210ax takes a maximum of 6.8 fl/oz.
- Reinstall -4AN allen plug.
- NOTE: After running the SC, the oil level will lower due to oil filling the bearings. The proper level while **not running** should be between the bottom of the sight glass and the middle and will vary when running and not running.

- Change SC oil every 100,000 miles and only use **WHIPPLE SC OIL OR FORD XL-4 OIL ONLY!!**

!! CAUTION !!

Severe damage to the compressor will occur if you overfill the supercharger front gear case.

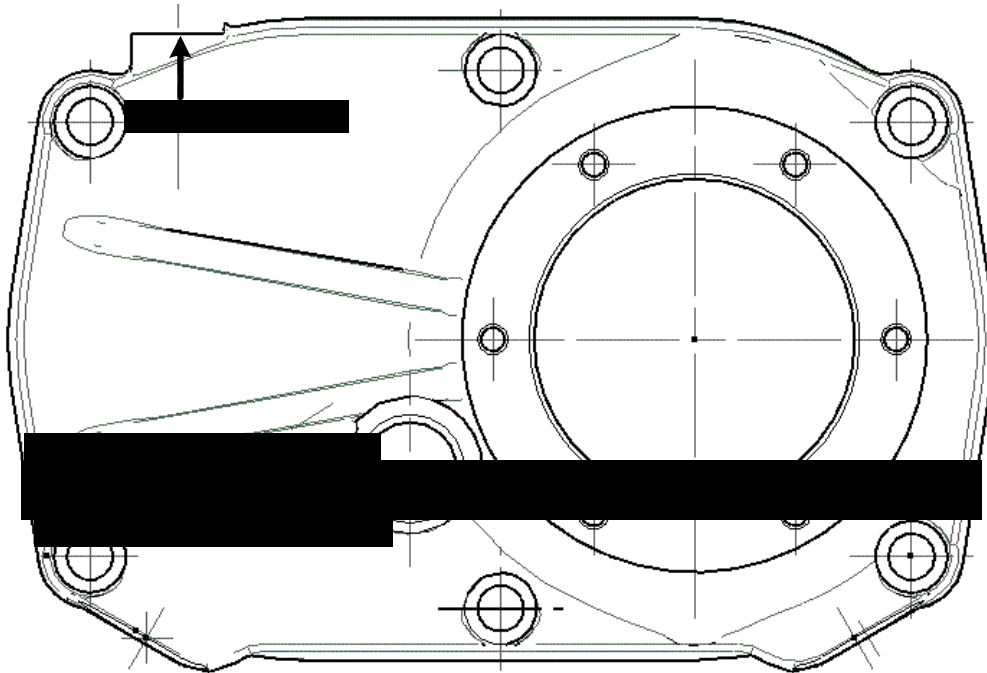

!! CAUTION !!

Severe damage to the compressor will occur if you overfill the supercharger front gear case.

79. Remove the bottom portion of the rear seat for access to the fuel pumps.
80. Remove the driver side fuel pump access cover by carefully lifting up with a flat head screw driver.



81. Disconnect the fuel pump electrical connector (driver side).

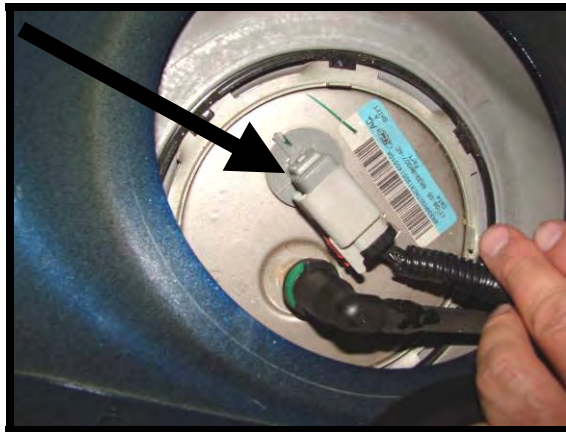

!! CAUTION !! If the liquid or vapor tube is damaged (torn, holes or delaminated), the affected tube assembly must be replaced with a new tube assembly. Do not use aftermarket sleeving. Do not re-adhere loose sleeving material.

!! CAUTION !! When reusing liquid or vapor tube connectors, make sure to use compressed air to remove any foreign material from the connector retaining clip area before separating from the tube. Apply clean engine oil to the end of the tube before inserting the tube into the connector.

!! CAUTION !! Fuel injection equipment is manufactured to very precise tolerances and fine clearances. It is therefore essential that absolute cleanliness be observed when working with these components. Always install blanking plugs to any open orifices or tubes.

82. Disconnect the fuel tube quick connect coupling on the fuel pump (driver side).

Press the fuel tube quick connect coupling button and pull the fuel tube to disconnect.

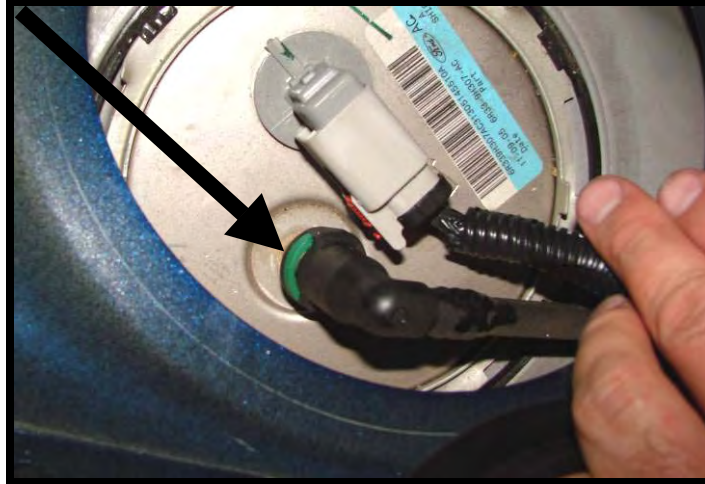

83. Using a fuel tank lock ring wrench or a brass punch, remove the fuel pump retaining lock ring.



!! CAUTION !! The fuel pump must be handled carefully to avoid damage to the float arm, filter, and the convolute hoses.

84. Carefully lift the fuel pump out of the fuel tank enough to access and release the fuel cross-over tube quick connect coupling from the fuel pump.



85. Completely remove the fuel pump from the fuel tank.



!! CAUTION !! Inspect the surfaces of the fuel pump mounting flange and fuel tank O-ring seal contact surfaces. Do not polish or adjust the O-ring seal contact area of the fuel tank flange or the fuel tank. Install a new fuel tank if the O-ring seal contact area is bent, scratched or corroded.

!! CAUTION !! Make sure to install a new fuel pump O-ring seal and lock ring.

86. 07 -2009 Fuel level sensor
The provided Dual fuel pump assembly is equipped with correct fuel level sensor for 2010 and newer cars, you must remove the sensor from your original fuel pump assembly and install on new modified pumps.

To remove sensor

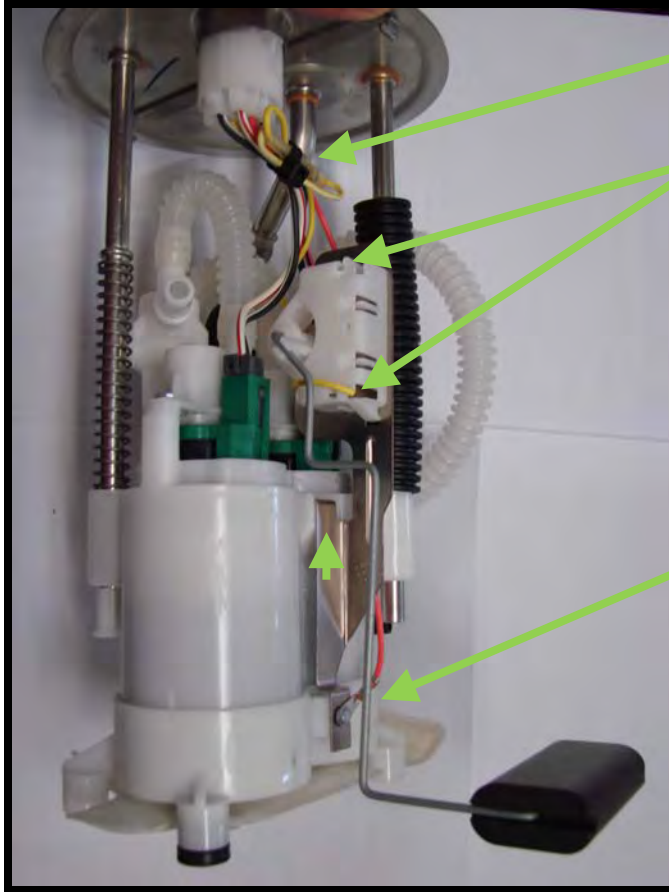

Cut zip tie holding wires together

2009 sensor shown yellow wire is on bottom of 07-09 units and on top on 2010 sensor.

Remove attachment screw holding bracket then slide bracket upwards to release Remove sensor assembly from pump.

87. Carefully cut clear tubing off yellow wire then depress tab and pull terminal apart

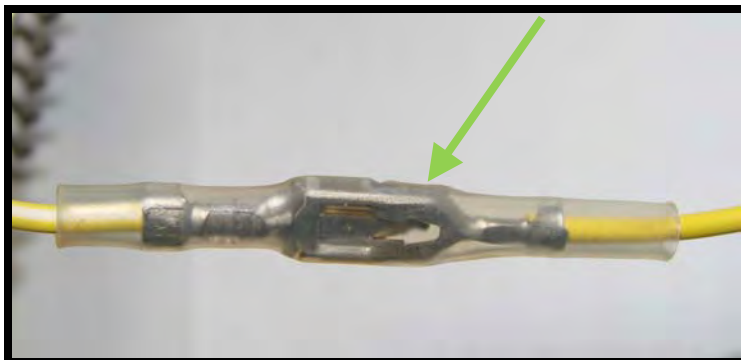

88. Remove sensor from new pump assembly .
89. Reverse process to install sensor use provided shrink tubing and zip tie, heat black tubing to shrink over terminal and tie wires up with zip tie (be careful that yellow wire is routed so it doesn't rub on bracket)
!!!CAUTION !!!
Be careful not to heat fuel lines when shrinking heat shrink they can be damaged by heat gun!

90. Install new fuel pump O-ring seal, apply clean engine oil to the O-ring seal



91. Position the high-flow dual fuel pump into the fuel tank.
92. Connect the cross-over fuel tube quick connect coupling to the fuel pump.
- Make sure the fuel tube clicks into place when installing the tube. To make sure that the fuel tube is fully seated, pull on the tube.**
93. Make sure the alignment arrows on the dual fuel pump and the fuel tank meet before tightening the dual fuel pump lock ring. Using the special tool or brass punch, install dual fuel pump with new lock ring.
- Tighten the lock ring until it meets the stops on the fuel tank. **NOTE:** The fuel pump is spring loaded into tank and may require slight pressure to install lock ring.
94. Connect the quick connect coupling on top of the dual fuel pump.
- Make sure the fuel tube clicks into place when installing the tube. To make sure that the fuel tube is fully seated, pull on the tube.**
95. Reconnect the battery ground connector using an 8mm socket.
96. Refill the engine coolant system with a 60% (distilled water)/40% (coolant such as Zerex G-05) mix of distilled water and **Ford approved engine coolant**. Whipple also recommends running 2 bottles of Redline Water Wetter which can be found at most automotive parts stores. **⚠ WARNING!! DO NOT USE TAP WATER OR ANY NON FORD APPROVED ENGINE COOLANT, THIS WILL CAUSE CORRISION IN THE SYSTEM. Start engine to completely fill system. Using a flat head screw driver, bleed the air-pockets from the cooling system. You must wait until the thermostat opens, which is after the designed temperature of the thermostat (stock 190deg F).**
97. Fill the IC system with a 70% (distilled water)/30% (coolant such as Zerex G-05) mix of distilled water and **Ford approved engine coolant**. Whipple also recommends running 2 bottles of Redline Water Wetter which can be found at most automotive parts stores. **⚠ WARNING!! DO NOT USE TAP WATER OR**

ANY NON FORD APPROVED ENGINE COOLANT, THIS WILL CAUSE CORROSION IN THE SYSTEM.

Start engine to completely fill system.

98. Install the supplied C.A.R.B. 50-state emissions sticker in a visible location on the factory radiator shroud. To properly install, use a light abrasive material such as scotch-brite to scuff the mounting area. Clean the area off with a cleaner that does not contain lubricants, then install the sticker.
99. Start engine and check for any fuel or coolant leaks.
100. **⚠ WARNING!!** Verify the bypass actuator is working properly. To monitor, look at the bypass arm when the motor is not running. Start engine and verify that the actuator arm has opened. This arm will be extended when the engine is above 1" of vacuum (boost) and will be open when there is more than 1" of engine vacuum

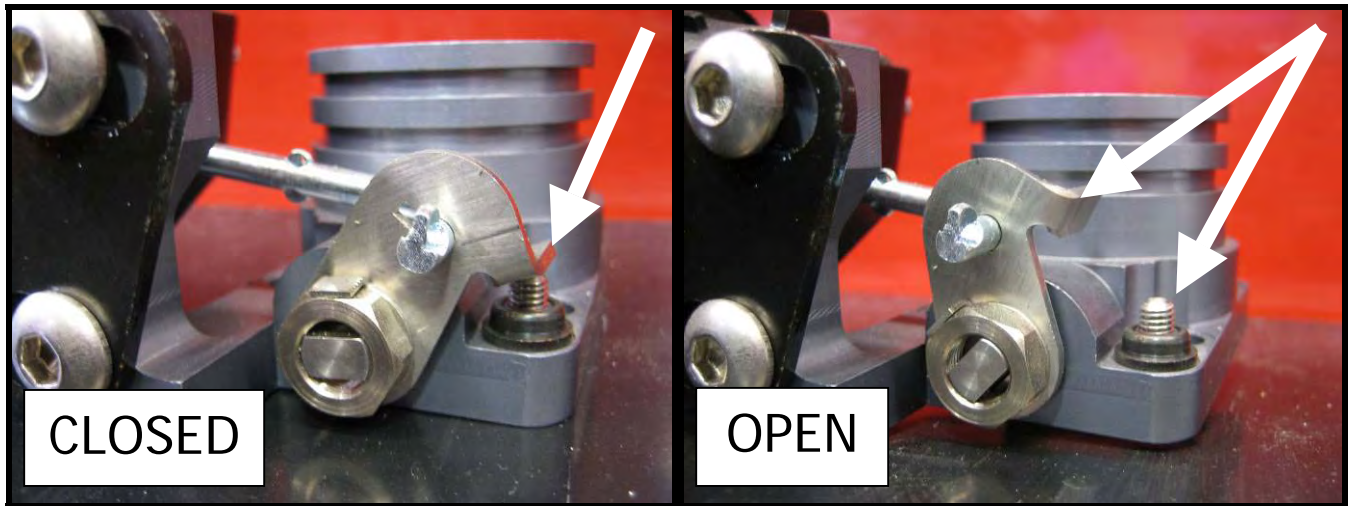

Maintenance and Service

Be sure to follow the maintenance and service recommendations below to optimize the life and performance of your Whipple-supercharged GT500.

Maintenance

For best performance and continued reliability it is essential to adhere to the following guidelines:

1. Use only premium grade fuel (91-octane or higher).
2. Always listen for any sign of spark knock or pinging. If present, discontinue use immediately and consult your vehicle owner's manual.
3. Do not overfill the supercharger front gear case.

!! CAUTION !!

Severe damage to the compressor will occur if you overfill the supercharger front gear case.

4. Do not operate the vehicle at large throttle opening if the MIL lamp is on steadily. This indicates an electronic engine control malfunction: reduce throttle opening and consult your vehicle dealer.
5. HIGH BOOST cars (19psi+) should inspect the actuator every 10,000 miles.
6. Inspect and clean your high-flow air filter element every 7,500 miles.
7. Inspect and replace spark plugs every 20,000 miles. Only run specified plugs such as NGK TR7IX for 12-18psi and NGK TR8IX for 19-25psi.
8. Follow your factory service intervals for oil changes and other typical maintenance items.

!! CAUTION !!

Any modification to your vehicle's new computer program may cause serious damage to the engine and/or drivetrain.

BYPASS ACTUATOR TESTING

⚠ WARNING!! MUST BE VERIFIED BEFORE TEST DRIVING

1. Plunge the actuator arm into the actuator.
2. Plug the top port with finger or rubber cap.
3. Release the actuator arm while still capping the top port.
4. Verify that the arm only slightly moved, if it went back to the closed position (resting on stop), then the actuator is ruptured/damaged and needs to be replaced IMMEDIATELY. If it checks ok, then re-install the 7/32" hose and secure with tie-wrap.

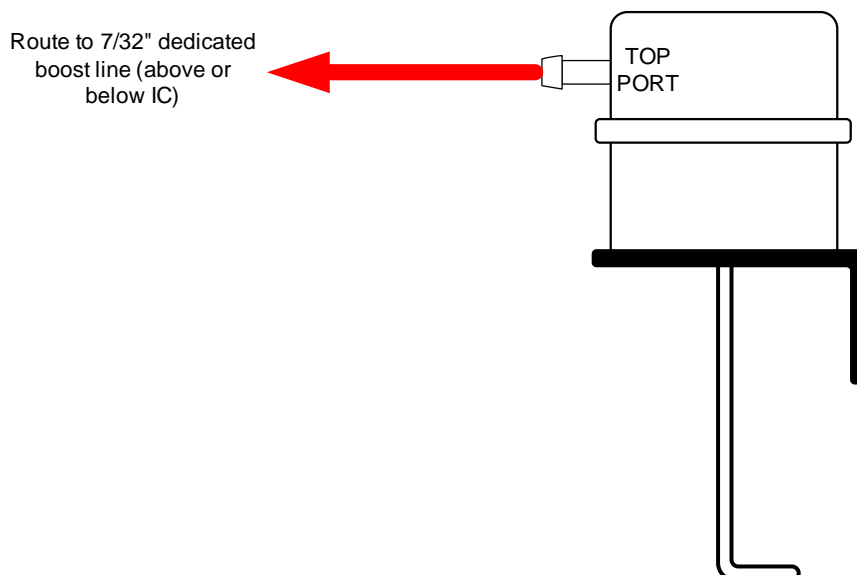

Servicing Your Supercharger

It is recommended that the following items be inspected at normal service intervals:

1. Check the supercharger oil level at every engine oil change. Add Whipple SC oil to the supercharger if required.
2. Check the supercharger/accessory drive belt. Adjust or replace as required.
3. Change the oil in the supercharger every 100,000 miles. Use Whipple SC oil or Ford #XL-4 oil only.

Follow these guidelines to properly maintain your Whipple-Supercharged GT500

Post-Installation Checklist

After installing the Whipple supercharger kit it is essential that the following checklist be completed.

!! CAUTION !!

Failure to complete the Post-Installation Checklist may result in severe engine damage.

1. Review the Maintenance and service section and familiarize yourself with the steps you must take to ensure your Whipple-supercharged vehicle will continue to operate with optimum performance.
2. Verify Fuel Octane: When you re-fuel your truck/SUV, ensure you use fuel of 91-octane or higher. It will always be beneficial to run 92-94 octane when available.

!! CAUTION !!

Use only 91-octane fuel or higher. If fuel of less than 91-octane is present in the vehicle fuel tank, the tank must be completely drained and refilled with 91 or higher octane to 1/8th of a tank.

3. Check Vehicle Fuel Pressure: Fuel pressure is critical to proper supercharger operation and must be checked during wide-open-throttle operation when the fuel tank is 1/8th full. Fuel pressure should meet all factory specifications.

Checklist Review

Have you completed the Post-Installation Checklist? Be sure you have:

1. Reviewed the Maintenance and Service Recommendations
 2. Verified the Fuel Octane
 3. Checked the Vehicle Fuel Pressure
- Have you completed all items in the **Post-Installation Checklist**?

NOTE

There are no warranties expressed or implied for engine failure or damage to the vehicle in any way during supercharger installation or use.

If you have completed the **Post-Installation Checklist**, you have successfully installed your Whipple FRPP Supercharger Kit.

Congratulations! Your supercharger installation is now complete.



LIMITED WARRANTY

All merchandise manufactured by Whipple Industries has a limited warranty against defects in workmanship and materials to the original purchaser of the Whipple Supercharger System for one calendar year from Whipple Industries ship date. The limited warranty must be signed, dated and returned to Whipple Industries within 30 days of the Whipple Industries ship date and must be accompanied by a copy of the original sales invoice. This warranty is non-transferable.

If an item is suspected of being defective, return it to Whipple Industries for inspection after obtaining the proper Return Authorization Number. If an item is determined to be defective, we will repair or replace it at our discretion within a period of one year from the shipping date on your invoice.

Whipple Industries Inc. limited warranty specifically does not apply to products which have been (a) modified or altered in any way, (b) subjected to adverse conditions such as misuse, neglect, accident, improper installation or adjustment, dirt, or other contaminants, water, corrosion or faulty repair; or (c) used in other than those specifically recommended by Whipple Industries Inc. All products designed for off-road use are considered racing parts and carry no warranty, either expressed or implied, as we have no control over how they are used.

On warranty items, repair/replacements will be limited to parts manufactured by Whipple Industries and will not include claims for labor or inconvenience. All other merchandise distributed by Whipple Industries is warranted in accordance with the respective manufacturer's own terms of warranty. This warranty is expressly made in lieu of any and all other warranties expressed or implied, including the warranties of merchantability and fitness.

Whipple Industries will not be responsible for any other expenses incurred by the customer under the terms of this warranty, nor shall it be responsible for any damages either consequential, special, contingent, expenses or injury arising directly or indirectly from the use of these products.

Whipple Industries reserves the right to determine whether the terms of the warranty, set out above, have been properly complied with. In the event that the terms are not complied with, Whipple Industries shall be under no obligation to honor this warranty. By signing this form, you understand and agree to the terms above.

NAME (Print) _____ ADDRESS _____

SIGNATURE _____ CITY _____ STATE _____ ZIP _____

DATE _____ PHONE _____

SC SERIAL # _____ EMAIL _____

(Found on compressor bearing plate) (Optional)

VIN # _____

CONGRATULATIONS

Your new Whipple Supercharger is engineered to significantly increase your engines power across a broad range of RPM's. It is Whipple and Ford Racings goal to improve your driving experience for many miles and years to come.

Whipple Superchargers operate as an air pump and contain internal rotors that are driven by the engine's crankshaft and serpentine belts. The supercharger compresses outside air and channels it into the engine's intake ports. Because of their design, superchargers may generate some additional noise over the standard, normally aspirated induction system.

At idle, you may hear a medium-pitch rattle from the supercharger main housing. This will diminish at about 400-500 rpm above idle.

You may also experience a muffled high-pitched whine during acceleration. This is caused by the pumping action of the supercharger compressing air and only occurs during boost conditions. It is inaudible during part-throttle acceleration.

These are normal noises associated with any supercharger and have no effect on supercharger performance or engine durability.

Your supercharger is warranted by Whipple Superchargers, please see your terms and conditions on the back of your invoice for more information in regards to the limited warranty. NOTE: Whipple Superchargers will not authorize any warranty repair work or supercharger replacement for normal noises.