



M-9603-CJ 123 mm Cold Air Kit for 5.4L 4V V8 Cobra Jet Mustang INSTALLATION INSTRUCTIONS

NO PART OF THIS DOCUMENT MAY BE REPRODUCED WITHOUT PRIOR AGREEMENT AND WRITTEN PERMISSION OF FORD RACING PERFORMANCE PARTS.

Please contact the Techline for the most current instruction information 1-800-367-3788.

!!! PLEASE READ THE FOLLOWING INSTRUCTIONS CAREFULLY PRIOR TO INSTALLATION !!!

OVERVIEW:

This kit is designed for use on 2008 Ford Mustang V8 Cobra Jet.

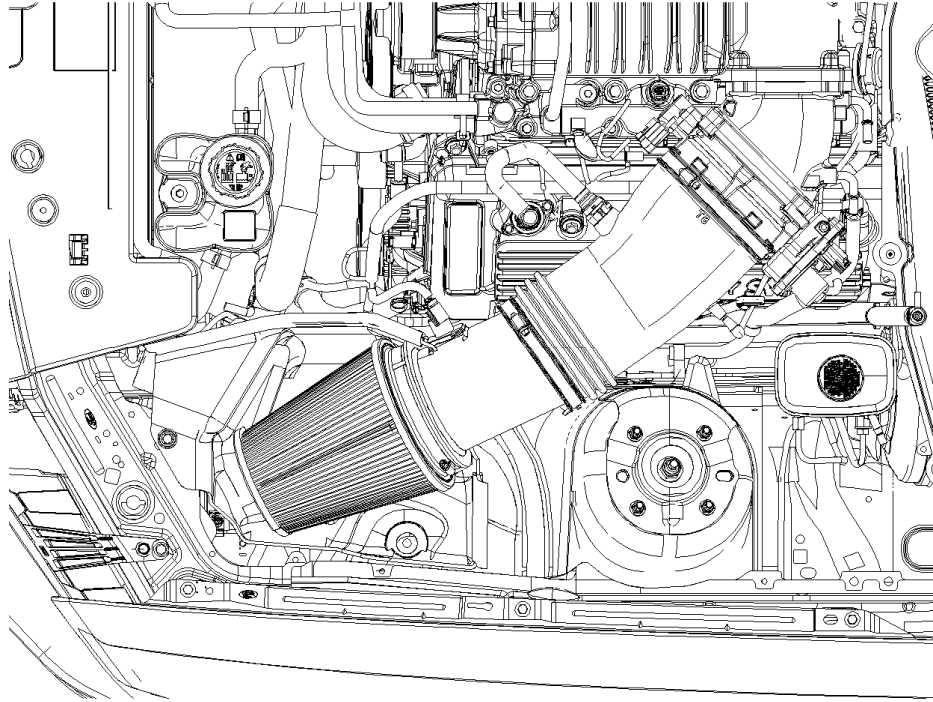

IMPROTANT NOTES:

- **Premium fuel required**
- **Vehicle requires a new calibration to correct air to fuel ratio. If vehicle is NOT calibrated correctly, engine failure will result. Installation of a wide-band A/F sensor is required to calibrate engine correctly.**
- **CALIBRATION REQUIRED, NOT INCLUDED!**

Please read the installation manual carefully and verify that all items are present. If you are missing hardware or have any questions, please contact the Ford Racing Techline at 1-800-367-3788.

- Premium fuel (91 octane or higher) is required to prevent "spark knock" or detonation under certain operating conditions. The use of fuel additives (i.e., octane boosters) is not recommended. There is a possibility that these chemicals can damage your engine and cause drivability issues with your vehicle.

Techline 1-800-367-3788

Factory Ford shop manuals are available from Helm Publications, 1-800-782-4356

IS-1850-0167



M-9603-CJ
123 mm Cold Air Kit for 5.4L 4V V8 Cobra Jet Mustang
INSTALLATION INSTRUCTIONS

NO PART OF THIS DOCUMENT MAY BE REPRODUCED WITHOUT PRIOR AGREEMENT AND WRITTEN PERMISSION OF FORD RACING PERFORMANCE PARTS.

KIT INCLUDES:



1



2



3

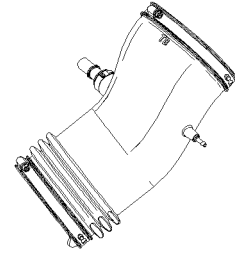

4

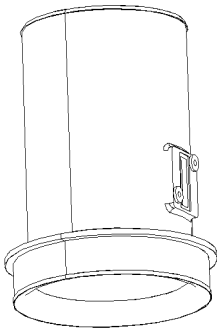

5



6



7



8

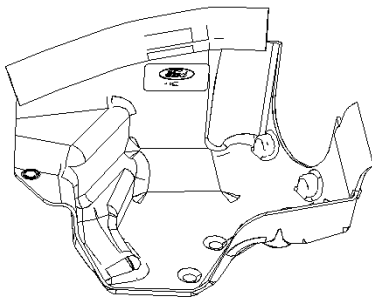

9

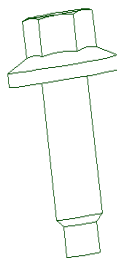

10



11



12

Techline 1-800-367-3788

Factory Ford shop manuals are available from Helm Publications, 1-800-782-4356



M-9603-CJ 123 mm Cold Air Kit for 5.4L 4V V8 Cobra Jet Mustang INSTALLATION INSTRUCTIONS

NO PART OF THIS DOCUMENT MAY BE REPRODUCED WITHOUT PRIOR AGREEMENT AND WRITTEN PERMISSION OF FORD RACING PERFORMANCE PARTS.

| <u>Item #</u> | <u>Qty</u> | <u>Part Number</u> | <u>Description</u> |
|---------------|------------|---|--------------------------------------|
| 1 | 1 | AR3V-9601-AA | FRT GT500 CAK Filter Element |
| 2 | 1 | 4G7Z-12B579-AB | MAF Sensor |
| 3 | 1 | 7R3Z-17C431-AA | Grommet for CJ CAK |
| 4 | 1 | 7R3Z-9B659-AA | Zip Tube for GT500 Crate Motor |
| 5 | 1 | CM-9600-CJ (Part of M-9600-CJ Kit) | Cobra Jet Billet Mass Air Meter Tube |
| 6 | 1 | CM-9600BRKT-CJ (Part of M-9600-CJ Kit) | CJ Air Cleaner Mounting Bracket |
| 7 | 1 | F5ZZ-9P686-AA | Insulator for CJ CAK |
| 8 | 1 | N605771-S439 | CJ Bracket to Tube and Airbox Bolt |
| 9 | 1 | R0713022-13-AA | CJ CAK Bucket |
| 10 | 2 | W505427-S301 | Bolt and Washer Assembly for CAK |
| 11 | 2 | W520812-S439 | J Clip |
| 12 | 2 | W709287-S300 | MAF MTG Bolts |

EQUIPMENT AND SUPPLIES REQUIRED:

- Metric Ratchet / Extension / Socket Set
- Torque Wrench
- T-20 Torx Bit Screwdriver or Socket

Techline 1-800-367-3788

Factory Ford shop manuals are available from Helm Publications, 1-800-782-4356

IS-1850-0167



M-9603-CJ 123 mm Cold Air Kit for 5.4L 4V V8 Cobra Jet Mustang INSTALLATION INSTRUCTIONS

NO PART OF THIS DOCUMENT MAY BE REPRODUCED WITHOUT PRIOR AGREEMENT AND WRITTEN PERMISSION OF FORD RACING PERFORMANCE PARTS.

SAFETY PRECAUTIONS:

!!! STOP! CAREFULLY READ THE IMPORTANT SAFETY PRECAUTIONS AND WARNINGS BEFORE PROCEEDING WITH THE INSTALLATION !!!

Appropriate disassembly and assembly methods and procedures are essential to ensure the personal safety of the individual performing the kit installation. Improper installation due to the failure to correctly follow these instructions could cause personal injury or death. Read each step of the installation manual carefully before starting the installation.

- Always wear safety glasses for eye protection.
- Place ignition switch in the OFF position.
- Always apply the parking brake when working on the vehicle.
- Block the front and rear tire surfaces to prevent unexpected vehicle movement.
- Operate the engine only in well-ventilated areas to avoid exposure to carbon monoxide.
- Do not smoke or use flammable items near or around the fuel system.
- Use chemicals and cleaners only in well-ventilated areas.
- Batteries can produce explosive hydrogen gas, which can cause personal injury. Therefore, do not allow flames, sparks or flammable sources to come near the battery.
- Keep hands and any other objects away from the radiator fan blades.
- Keep yourself and your clothing away from moving parts when the engine is running.
- Do not wear loose clothing or jewelry which can be caught in rotating or moving parts.

DISASSEMBLY INSTRUCTIONS:

The following section will guide you through the disassembly of the stock components. Special care should be taken to label fasteners and parts that are taken off during this procedure since many will be reused.

STEP 1: Cover both fenders with fender covers to protect the vehicle finish.

STEP 2: Disconnect the negative (-) and positive (+) connections to the battery. Cover the positive (+) battery terminal to prevent any contact.

Techline 1-800-367-3788

Factory Ford shop manuals are available from Helm Publications, 1-800-782-4356

NO PART OF THIS DOCUMENT MAY BE REPRODUCED WITHOUT PRIOR AGREEMENT AND WRITTEN PERMISSION OF FORD RACING PERFORMANCE PARTS.

STEP 3: Disconnect the MAF wiring from the airbox. Loosen the clean air tube clamp and disconnect the clean air tube from the airbox and throttle body.

STEP 4: Disconnect PCV tube and vacuum line and remove clean air tube.

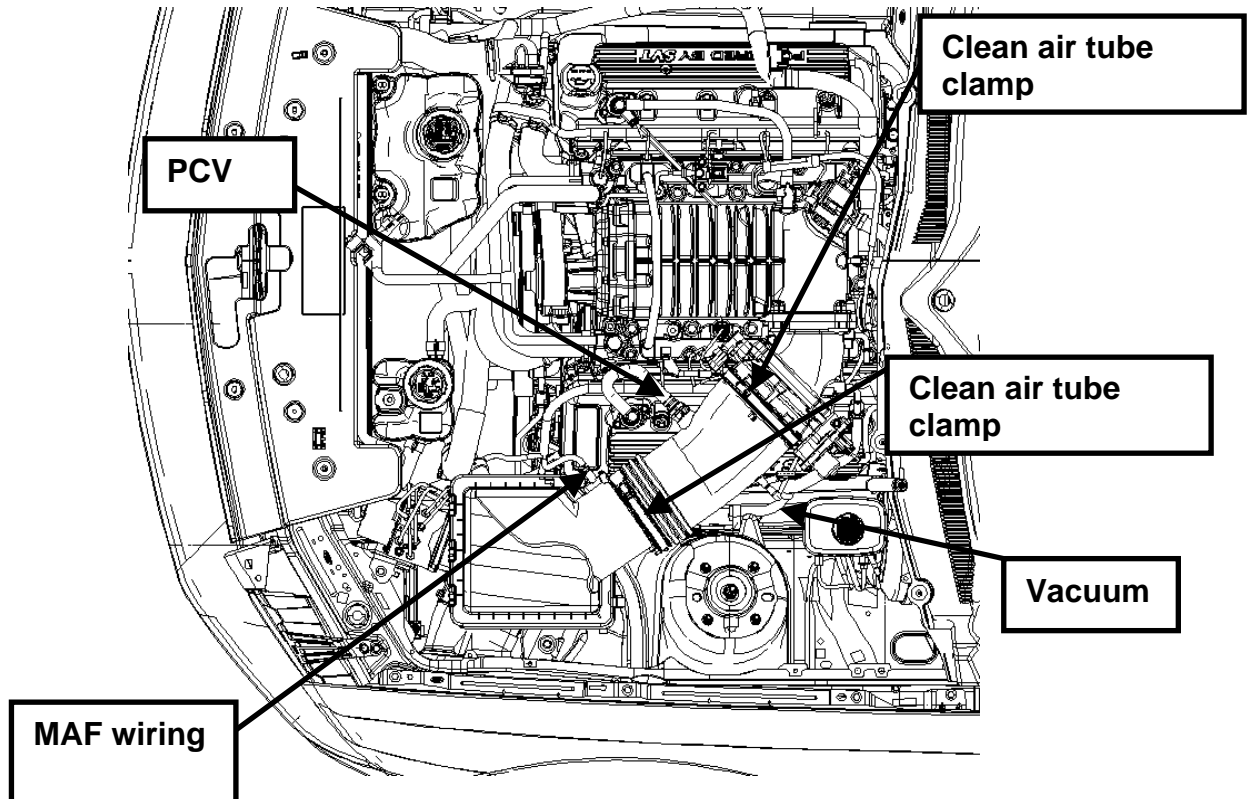

Techline 1-800-367-3788

Factory Ford shop manuals are available from Helm Publications, 1-800-782-4356



M-9603-CJ
123 mm Cold Air Kit for 5.4L 4V V8 Cobra Jet Mustang
INSTALLATION INSTRUCTIONS

NO PART OF THIS DOCUMENT MAY BE REPRODUCED WITHOUT PRIOR AGREEMENT AND WRITTEN PERMISSION OF FORD RACING PERFORMANCE PARTS.

STEP 5: Remove the airbox retainer bolt and airbox from the vehicle.

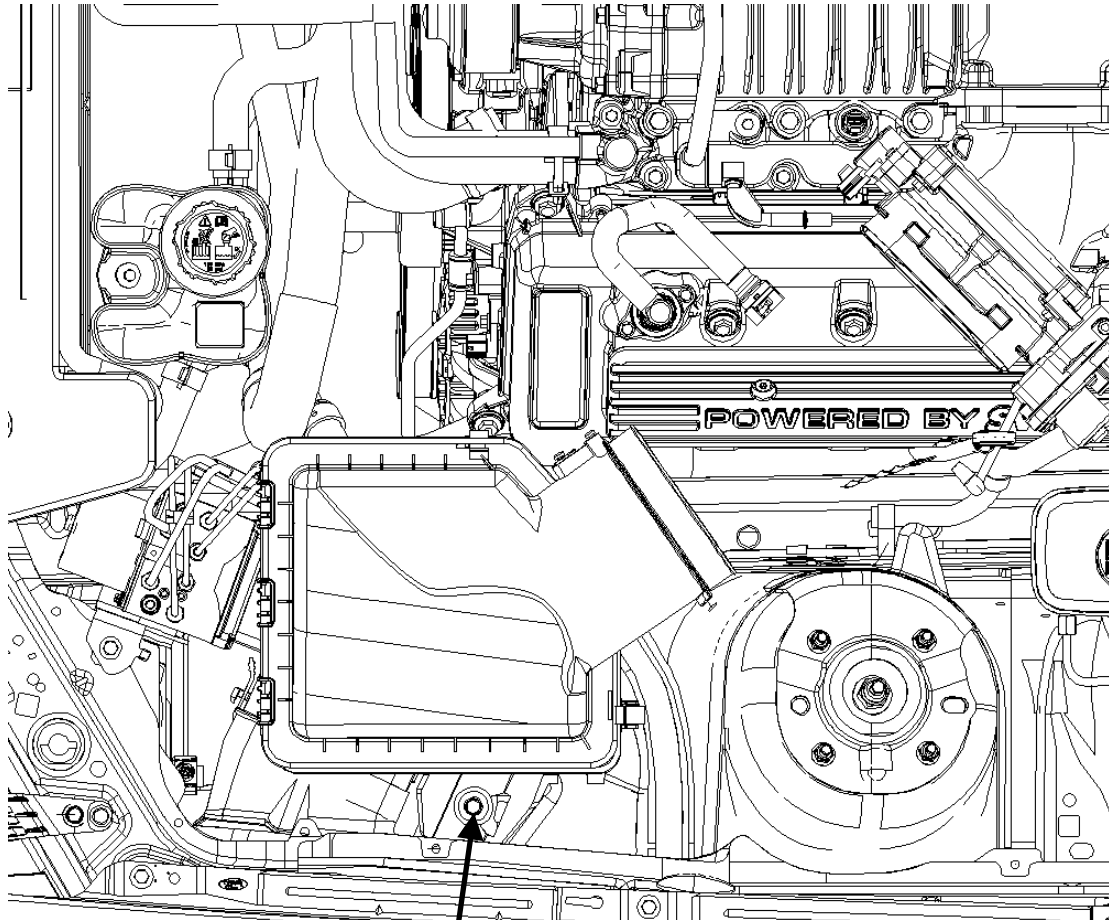

Remove airbox mounting bolt

Techline 1-800-367-3788

Factory Ford shop manuals are available from Helm Publications, 1-800-782-4356

IS-1850-0167



M-9603-CJ 123 mm Cold Air Kit for 5.4L 4V V8 Cobra Jet Mustang INSTALLATION INSTRUCTIONS

NO PART OF THIS DOCUMENT MAY BE REPRODUCED WITHOUT PRIOR AGREEMENT AND WRITTEN PERMISSION OF FORD RACING PERFORMANCE PARTS.

INSTALLATION INSTRUCTIONS:

The following section will guide you through the installation of this kit. If you need to stop during any part of the installation, make sure you cover the clean air tube inlet to prevent foreign material from contaminating your engine.

STEP 1: Install the MAF sensor and bolts from the kit into the new air intake meter assembly. Torque the bolts to 4 Nm (35 lb in).

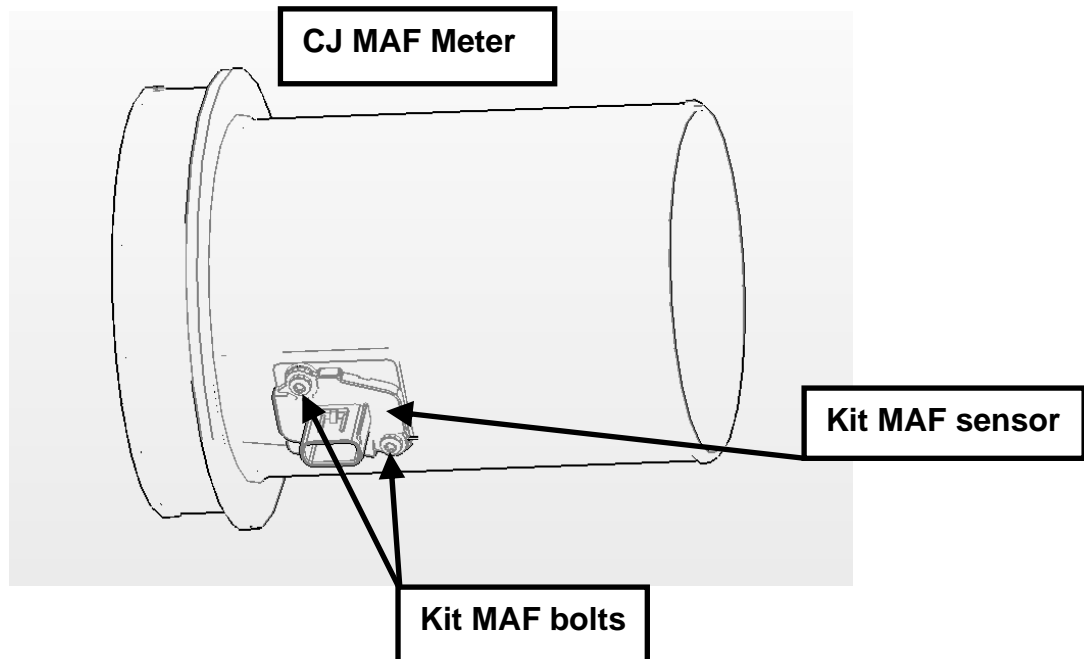

STEP 2: Trim air intake bucket using element outer diameter for template.

Techline 1-800-367-3788

Factory Ford shop manuals are available from Helm Publications, 1-800-782-4356

IS-1850-0167



M-9603-CJ 123 mm Cold Air Kit for 5.4L 4V V8 Cobra Jet Mustang INSTALLATION INSTRUCTIONS

NO PART OF THIS DOCUMENT MAY BE REPRODUCED WITHOUT PRIOR AGREEMENT AND WRITTEN PERMISSION OF FORD RACING PERFORMANCE PARTS.

STEP 3: Install CM-9600BRKT-CJ to bucket mounting hole outside edge. With bolt in this location, torque to 25 Nm (221 lb in).

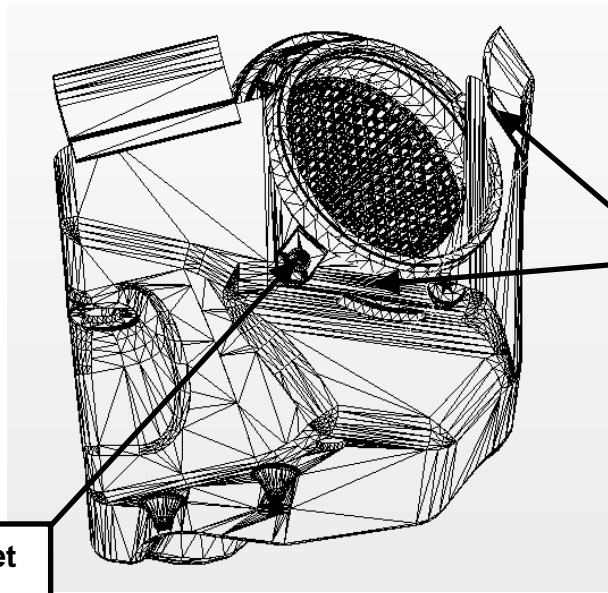

Install support bracket

Cut air intake bucket for larger MAF to fit

STEP 4: Lower the complete air intake bucket assembly into the vehicle using the two pegs as guides into the rubber grommets. Use the new air intake bucket bolt and newly supplied J-clips to secure the air intake bucket in the vehicle. Torque the M6 bolt to 8 Nm (70 lb in).

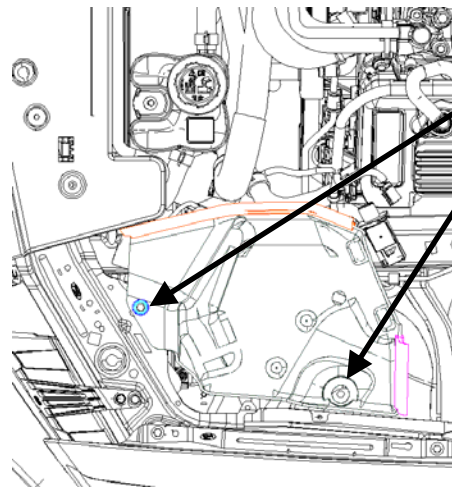

Mounting bolts and grommets through air intake bucket to J-clips in body

Techline 1-800-367-3788
Factory Ford shop manuals are available from Helm Publications, 1-800-782-4356



M-9603-CJ 123 mm Cold Air Kit for 5.4L 4V V8 Cobra Jet Mustang INSTALLATION INSTRUCTIONS

NO PART OF THIS DOCUMENT MAY BE REPRODUCED WITHOUT PRIOR AGREEMENT AND WRITTEN PERMISSION OF FORD RACING PERFORMANCE PARTS.

- STEP 5:** When installing the meter and element assembly, make sure to hook the element clamp over air filter mounting bracket.
- STEP 6:** Install the new rubber clean air tube onto the throttle body and air intake bucket assembly.
- STEP 7:** Tighten the worm-drive clamps and torque to 3 Nm (26 lb in).
- STEP 8:** Reinstall the MAF electrical connector onto the MAF sensor and reconnect the PCV and vacuum hose.

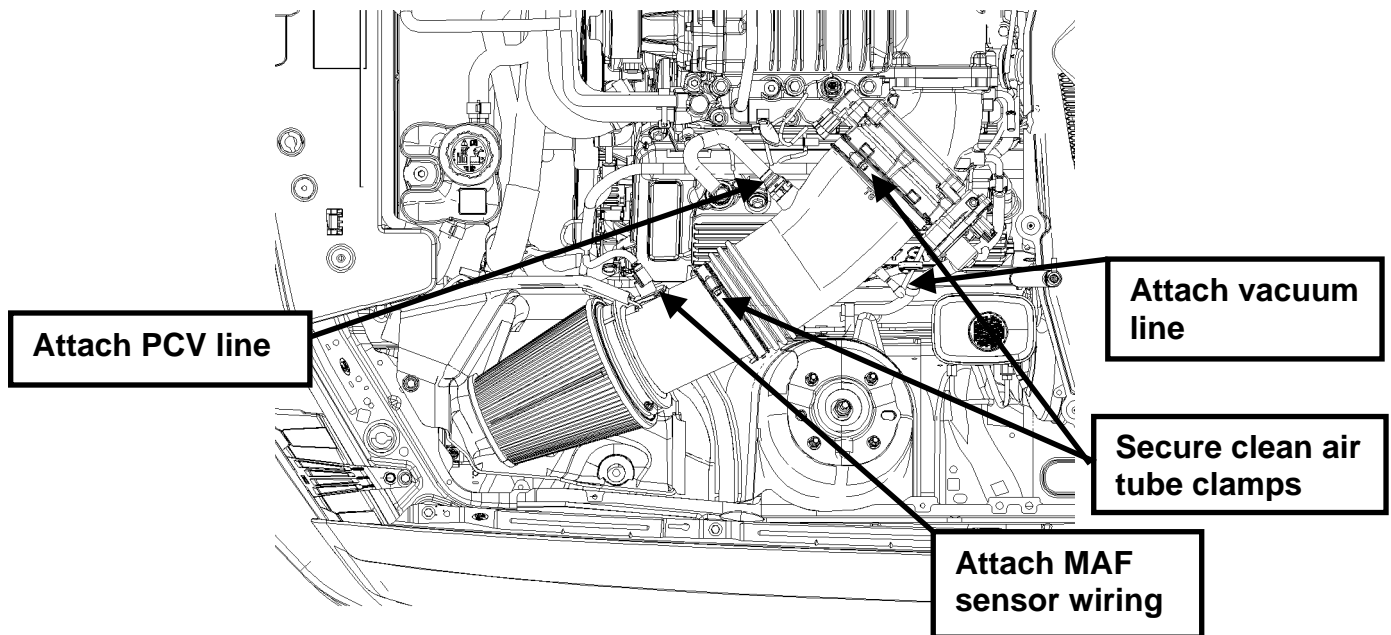

- STEP 9:** Reinstall the battery connections. Connect the positive (+) cable to the battery first then the negative (-) cable. Check to ensure that the battery is fully charged (12.0V to 14.5V).
- STEP 10:** Check for unusual noises, dash service lights and unusual operation. If problems are detected, immediately stop the engine or vehicle, diagnose and repair the problem.

IMPROTANT NOTES:

- Premium fuel required
- Vehicle requires a new calibration to correct air to fuel ratio. If vehicle is NOT calibrated correctly engine failure will result. Installation of a wide-band A/F sensor is required to calibrate engine correctly.
- CALIBRATION REQUIRED, NOT INCLUDED!

Techline 1-800-367-3788

Factory Ford shop manuals are available from Helm Publications, 1-800-782-4356

IS-1850-0167