



INTAKE SYSTEMS FOR VEHICLES LISTED ARE 50 STATE LEGAL. SEE KNFILTERS.COM FOR CARB STATUS ON EACH PART FOR A SPECIFIC VEHICLE.

INSTALLATION INSTRUCTIONS

57-1548

JEEP

2005-09 Grand Cherokee

2006-09 Commander

V8-4.7L

TOOLS NEEDED:

- Flat Blade Screwdriver
- 4mm Allen Wrench
- 10mm Wrench
- 7/16" Wrench
- 10mm Socket
- 13mm Socket
- Extension
- Ratchet

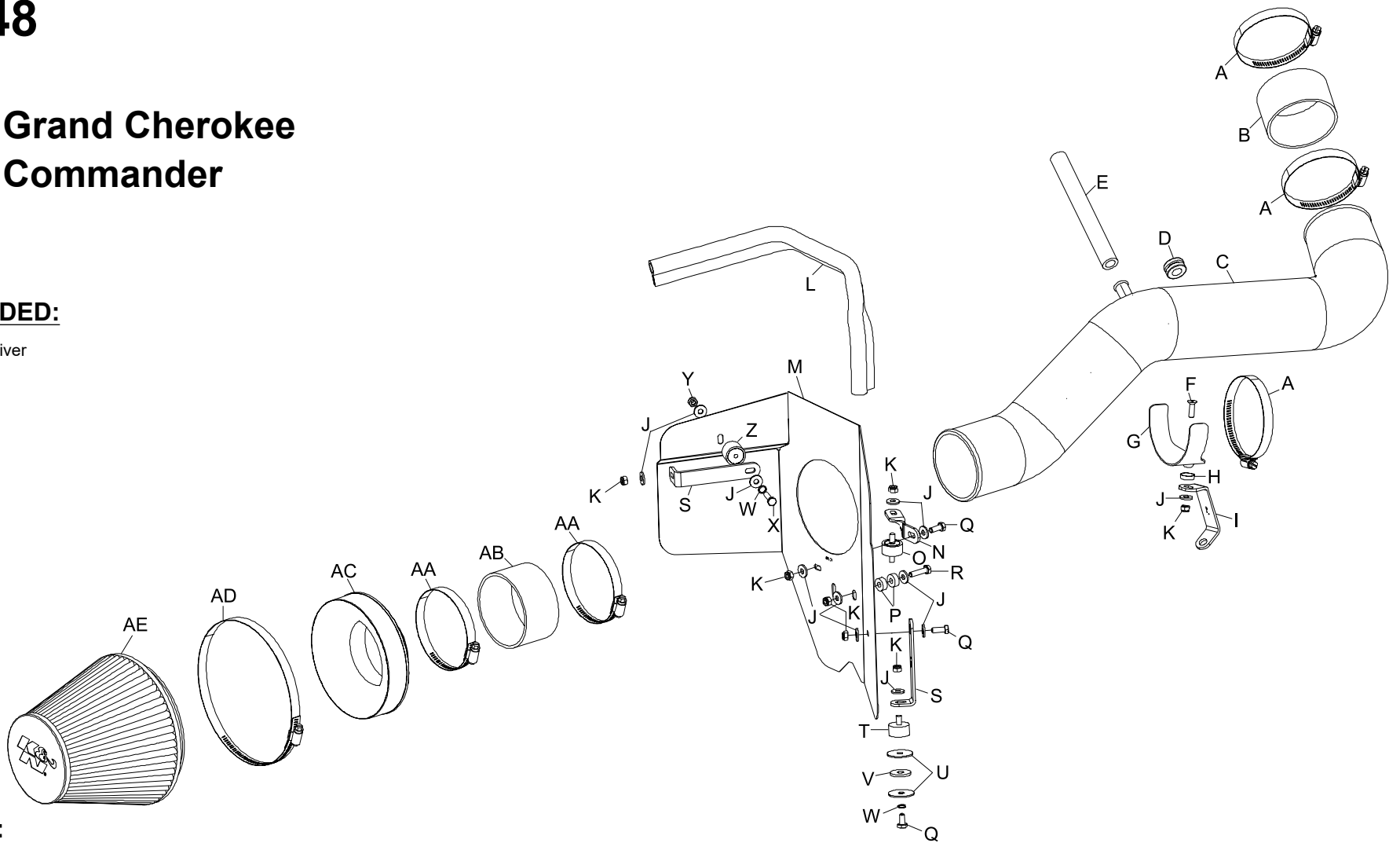

PARTS LIST:

Description	Qty.	Part #	Description	Qty.	Part #	Description	Qty.	Part #
A HOSE CLAMP; #52	3	08610	L EDGE TRIM; 17"L	1	102469	W WASHER; 1/4" LOCK	2	08198
B HOSE; 3.25"ID X 2"L	1	08690	M HEAT SHIELD	1	07321	X BOLT; 1/4-20 X 1/2"	1	08317
C INTAKE TUBE; (FM)	1	087185A	N BRACKET; TWIST	1	010117	Y NUT; 1/4"-20 NYLOCK	1	07517
D GROMMET; 1"OD, 1/2"ID	1	08064	O STUD; M6-1.00 RUBBER	1	07027	Z STUD; 1/4-20	1	070226
E HOSE; 1/2"ID X 7"L	1	08159	P SPACER; .625"OD X .250"ID	2	06555	AA HOSE CLAMP; #56	2	08620
F BOLT; M6-1.00 X 20MM	1	08376	Q BOLT; M6-1.00 X 16MM	3	07703	AB HOSE; 3.5"ID X 2"L	1	08630
G BRACKET; SADDLE	1	078855	R BOLT; M6-1 X 30	1	1-1016	AC ADAPTER; 6"	1	21512-1
H WASHER; CONICAL	1	08180	S BRACKET; "L"	2	070952A	AD HOSE CLAMP; #104	1	08697
I BRACKET; "C"	1	26614	T STUD, RUBBER	1	070228	AE AIR FILTER	1	RU-1048
J WASHER; 1/4"ID X 5/8"OD	12	08275	U WASHER; 1.25"OD X .28	2	08151			
K NUT; 6MM NYLOCK	7	07553	V WASHER; 1" X .300" X .063	1	21685			

If you need any assistance please call 1-800-858-3333 to speak with a representative in our Customer Service Center before returning the product.

NOTE: FAILURE TO FOLLOW INSTALLATION INSTRUCTIONS AND NOT USING THE PROVIDED HARDWARE MAY DAMAGE THE INTAKE TUBE, THROTTLE BODY AND ENGINE.

TO START:

1. Turn off the ignition and disconnect the negative battery cable.
NOTE: Disconnecting the negative battery cable erases pre-programmed electronic memories. Write down all memory settings before disconnecting the negative battery cable. Some radios will require an anti-theft code to be entered after the battery is reconnected. The anti-theft code is typically supplied with your owner's manual. In the event your vehicles anti-theft code cannot be recovered, contact an authorized dealership to obtain your vehicles anti-theft code.



2. On 2008 and later model vehicles, pull up on the engine cover to dislodge it from the mounting grommets and then remove the engine cover from the vehicle.

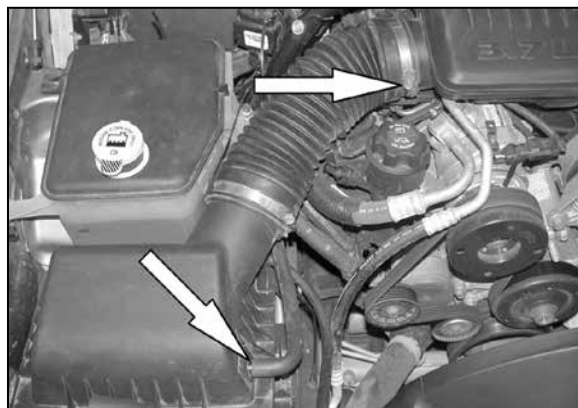

2a. Loosen the hose clamp, which secures the stock intake tube to the intake plenum, and disconnect the crankcase vent hose from the airbox lid.



3. Unclip the upper airbox retaining clips and remove the upper airbox and intake tube assembly as shown.



4. Disconnect the vacuum canister hose shown. **NOTE: Some vehicles may not be equipped with a vacuum canister.**

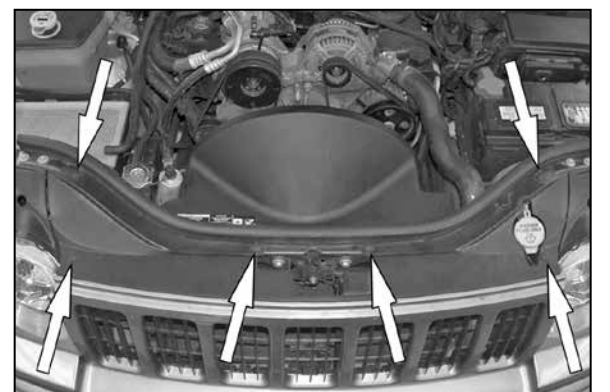

5. Using a small screwdriver, release the center holding pins in the six grill retaining clips shown.



6. Remove the six grill retaining clips from the grill, then tilt the grill forward and lift to remove from the vehicle.



7. Pull the fresh air duct forward to disconnect it from the airbox and then remove it from the vehicle.

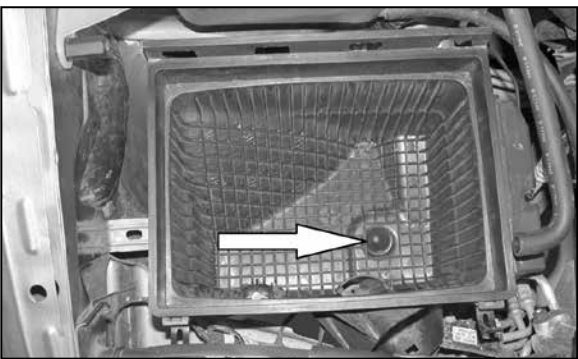

8. Remove the airbox mounting bolt shown.

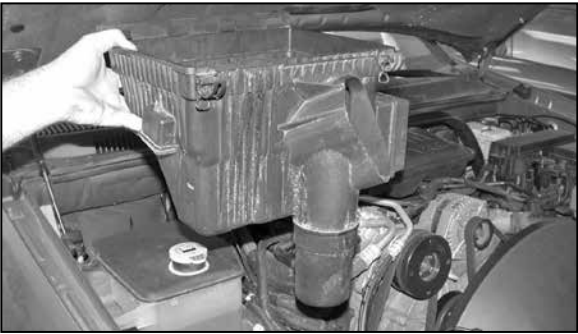

9. Lift the lower airbox and remove it from the vehicle as shown.

NOTE: K&N Engineering, Inc., recommends that customers do not discard factory air intake.

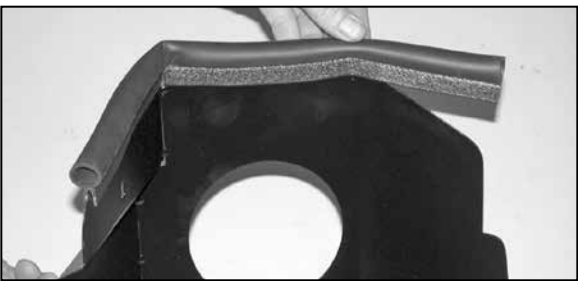

10. Install the provided edge trim onto the heat shield as shown.

NOTE: Some trimming of the edge trim may be necessary.



11. Install the 1/4"-20 male/female rubber mounted stud onto the "L" bracket (070952) with the provided hardware as shown.

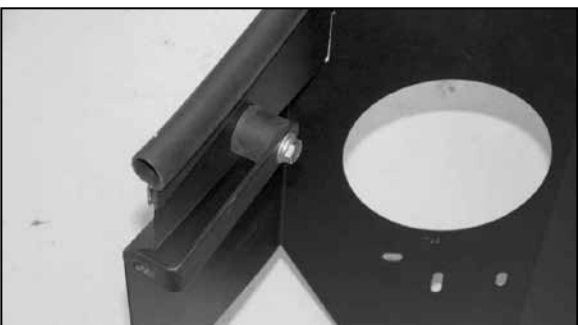

12. Install the bracket/rubber mounted stud assembly onto the heat shield as shown using the provided hardware.

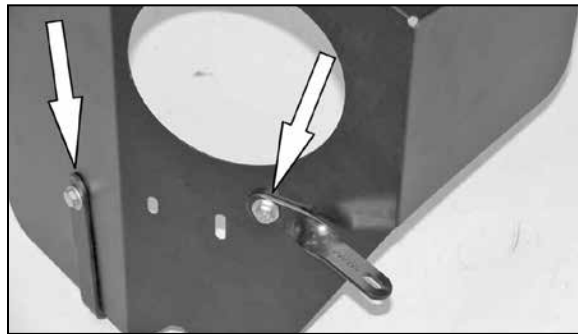

13. Install the heat shield mounting bracket and twist bracket onto the heat shield as shown using the provided hardware.

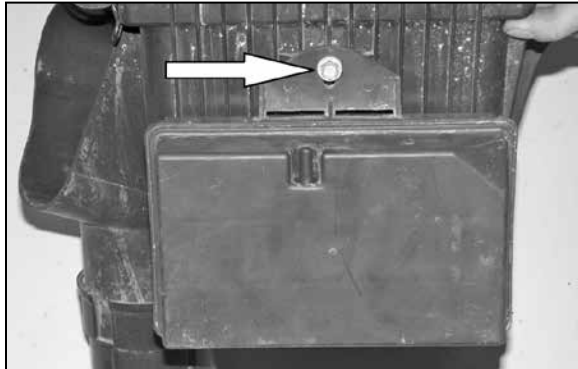

14. Remove the bolt which secures the vacuum reservoir to the airbox and then remove the reservoir from the airbox.

NOTE: Some vehicles may not be equipped with a vacuum reservoir.



15. Using the provided spacer, install the vacuum reservoir onto the heat shield as shown.

NOTE: Due to vehicle manufacturing tolerances, 2 spacers may be required.
NOTE: Some vehicles may not be equipped with a vacuum reservoir.

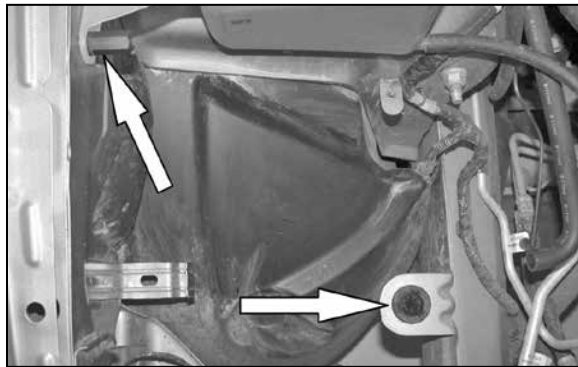

16. Remove the coolant reservoir-retaining nut and airbox mounting grommet shown.



17. Using the two fender washers and one rubber washer, install the 6mm male/female rubber mounted stud onto the lower airbox mount as shown.



18. Install the 6mm male/male rubber mounted stud onto the upper airbox mount as shown.



19. Install the heat shield assembly into the vehicle and secure it to the mounting locations with the provided hardware.



20. Reconnect the vacuum reservoir vacuum line.

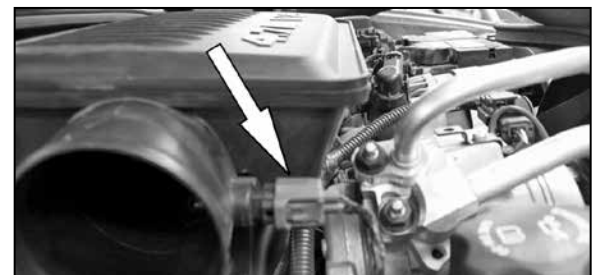

20a. Disconnect the air temperature electrical connection.



20b. Remove the two bolts which secure the intake plenum to the intake manifold.

NOTE: Some vehicles may have a hose clamp which secures the intake plenum to the throttle body which will need to be loosened.



20c. Remove the intake plenum from the vehicle as shown.

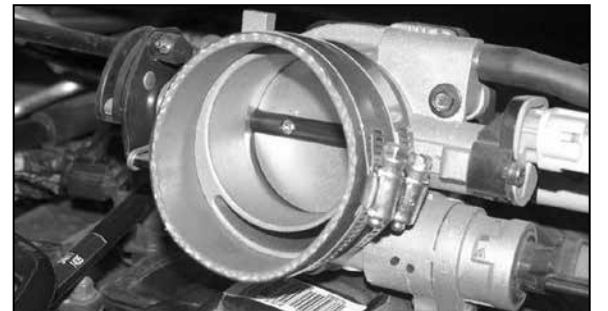

21. Install the silicone hose (08690) onto the throttle body and secure with the provided hose clamp.



22. Install the saddle clamp onto the tube mounting bracket and secure with the provided hardware as shown.

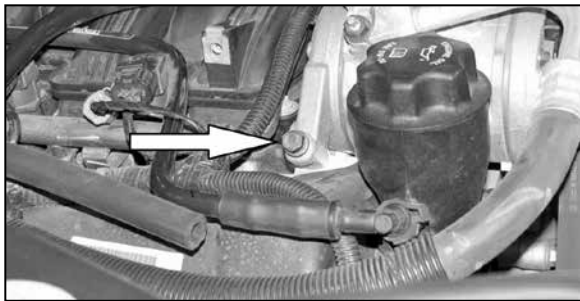

23. Remove the Lower rear A/C mounting bolt shown.

NOTE: This bolt will be reused.



24. Install the tube mounting bracket assembly onto the A/C compressor and secure with the factory-mounting bolt removed in step #23.



25. Rotate the air temperature sensor counter clockwise and remove the sensor from the stock intake plenum as shown.



26. Install the supplied rubber grommet into the K&N intake tube as shown.

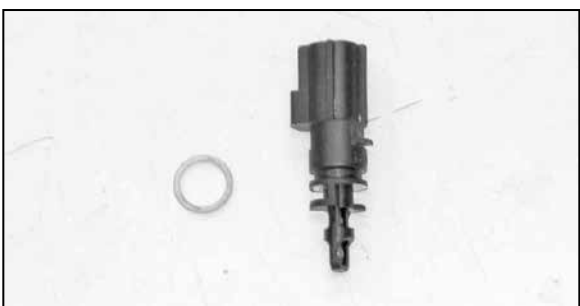

27. Remove the rubber sealing "O" ring from the air temperature sensor as shown.



28. Install the air temperature sensor into the K&N intake tube as shown.



29. Install the K&N intake tube into the silicone hose at the throttle body and onto the saddle clamp, then secure with the provided hose clamps as shown.

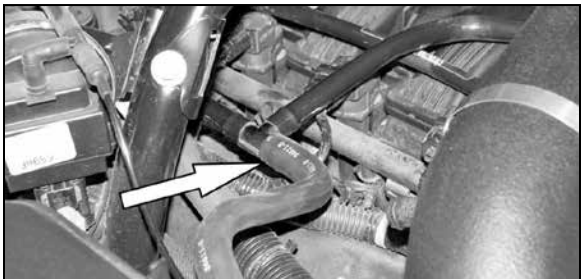

30. Remove the factory crankcase vent hose from the "T" fitting shown.

NOTE: Some vehicles may not have the described "T" fitting, the crank case vent fitting will be attached directly to the valve cover.

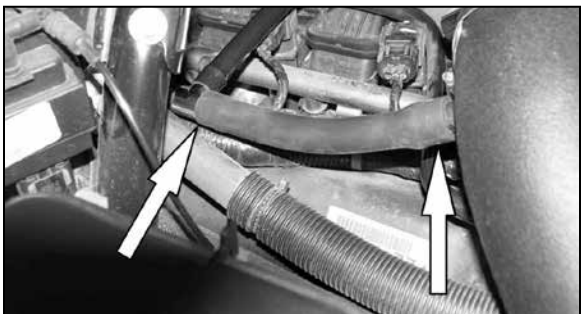

31. Install the supplied silicone hose onto the crankcase vent "T" and connect the other end onto the K&N intake tube as shown.

NOTE: Some vehicles may not have the described "T" fitting, the crank case vent fitting will be attached directly to the valve cover.



32. Install the filter adapter into the air filter as shown, secure with the provided hose clamp.



33. Install the silicone (08630) onto the air filter assembly and secure with the provided hose clamp.

NOTE: Drycharger air filter wrap; part # RF-1048DK is available to purchase separately. To learn more about Drycharger filter wraps or look up color availability please visit <http://www.knfilters.com>.

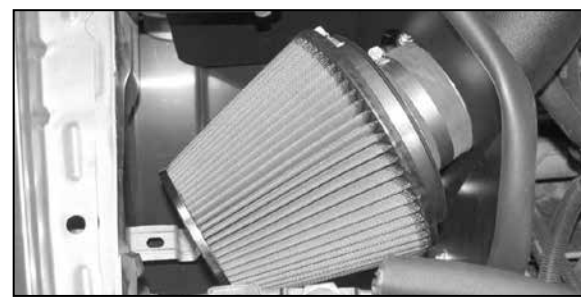

34. Install the air filter assembly onto the K&N intake tube as shown and secure with the provided hose clamp.



35. Reinstall the grill assembly with the factory retaining clips removed in step #5



36. Reconnect the vehicle's negative battery cable. Double check to make sure everything is tight and properly positioned before starting the vehicle.

37. The C.A.R.B. exemption sticker, (attached), must be visible under the hood so that an emissions inspector can see it when the vehicle is required to be tested for emissions. California requires testing every two years, other states may vary.

38. It will be necessary for all K&N high flow intake systems to be checked periodically for realignment, clearance and tightening of all connections. Failure to follow the above instructions or proper maintenance may void warranty.

ROAD TESTING:

1. Start the engine with the transmission in neutral or park. Listen for air leaks or odd noises. For air leaks secure hoses and connections. For odd noises, find cause and repair before proceeding. This kit will function identically to the factory system except for being louder and much more responsive.

2. Test drive the vehicle. Listen for odd noises or rattles and fix as necessary.

3. If road test is fine, you can now enjoy the added power and performance from your kit.

4. K&N Engineering, Inc., requires cleaning the intake system's air filter element periodically for excessive dirt build-up. When used in harsh terrain conditions or off-road environments, our filters will require cleaning more often. We recommend that you visually inspect your filter more frequently when used in harsh terrain conditions to determine if the screen is still visible. When the screen is no longer visible some place on the filter element, it is time to clean it. To clean and re-oil, purchase our filter Recharger service kit, part number 99-5050 or 99-5000 and follow the easy instructions.

LEGAL IN CALIFORNIA ONLY FOR RACING VEHICLES WHICH MAY NEVER BE USED, REGISTERED OR LICENSED FOR USE UPON A HIGHWAY.

See knfilters.com for CARB status on each part for a specific vehicle