



INTAKE SYSTEMS FOR VEHICLES LISTED ARE 50 STATE LEGAL. SEE KNFILTERS.COM FOR CARB STATUS ON EACH PART FOR A SPECIFIC VEHICLE.

INSTALLATION INSTRUCTIONS

57-2535
FORD / MAZDA
1995-97 Ranger / B2300
L4-2.3L MANUAL TRANS ONLY

NOTE: This kit was not designed to fit vehicles with a body lift.

TOOLS NEEDED:

- Flat blade screwdriver
- Ratchet
- Extension
- 8mm socket
- 10mm socket
- 13mm socket
- 5mm Allen
- 4.5mm Allen
- 5/8 wrench
- Pliers

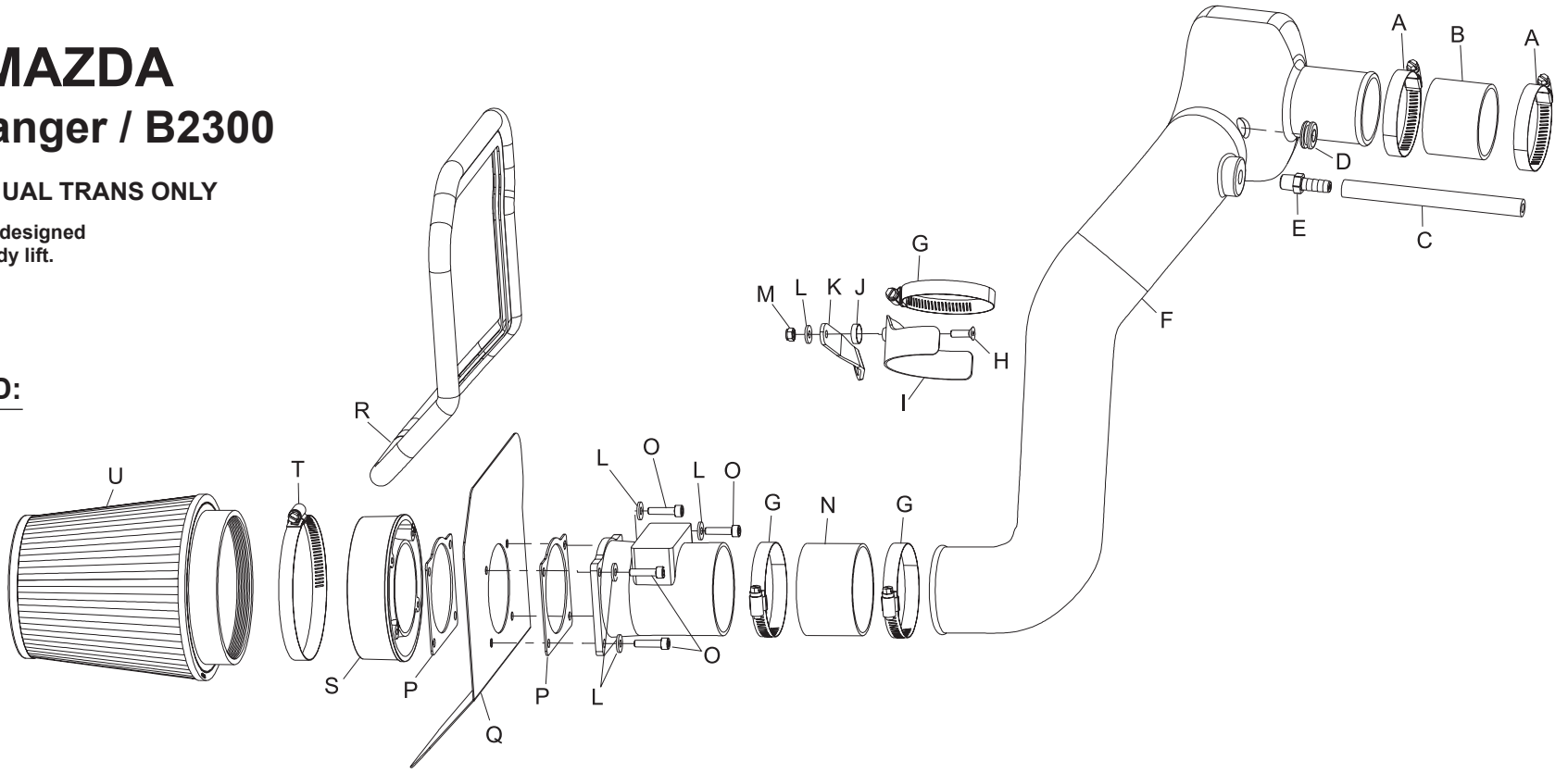

PARTS LIST:

Description	Qty.	Part #	Description	Qty.	Part #	Description	Qty.	Part #
A Hose clamp #40	2	08554	H Bolt; 6mm-1.00x20mm f/h/a ss	1	08376	O Bolt;6mm-1.00 x 25mm allen	4	07859
B Silicone hose, 2-3/8"IDx2"L	1	08405	I Saddle bracket	1	078855	P Mass air gasket	2	09202
C Silicone hose, 8mm IDx6-1/2"L	1	084020	J Washer, conical, nylon black	1	08180	Q Heat shield	1	07467
D Grommet; .687"od	1	08092	K Bracket	1	07136	R Edge trim 35"L	1	102471
E .250" NPT by .250"	1	08047	L Washer;1/4"idx5/8"od	5	08275	S Radius adaptor	1	21510
F Intake tube (CC)	1	087051	M Nut; 6mm nylock hexhead	1	07553	T Hose clamp #80	1	08694
G Hose clamp #44	3	08577	N Silicone hose, 3"id x 2"L	1	08711	U Filtercharger	1	RF-1037

NOTE: FAILURE TO FOLLOW INSTALLATION INSTRUCTIONS AND NOT USING THE PROVIDED HARDWARE MAY DAMAGE THE INTAKE TUBE, THROTTLE BODY AND ENGINE.

TO START:

1. Turn off the ignition and disconnect the negative battery cable.
NOTE: Disconnecting the negative battery cable erases pre-programmed electronic memories. Write down all memory settings before disconnecting the negative battery cable. Some radios will require an anti-theft code to be entered after the battery is reconnected. The anti-theft code is typically supplied with your owner's manual. In the event your vehicles' anti-theft code cannot be recovered, contact an authorized dealership to obtain your vehicles anti-theft code.



2. Disconnect the air temp. electrical sensor as shown.



3. Remove the crank case vent from the intake tube as shown.

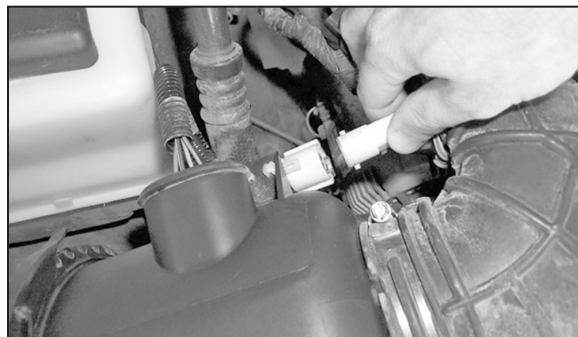

4. Disconnect the mass air electrical connection as shown.



5. Disconnect the mass air wiring loom from the intake tube as shown.

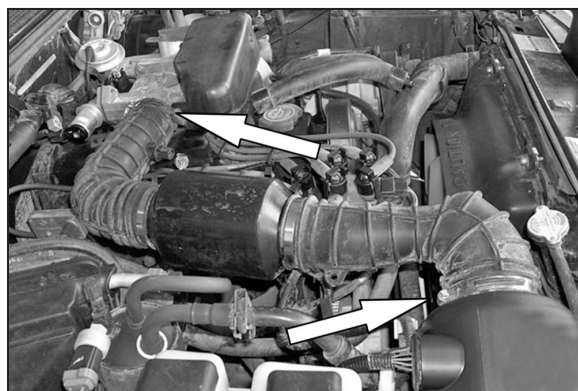

6. Loosen the two hose clamps at the throttle body and air box.



7. Remove the intake tube as shown.

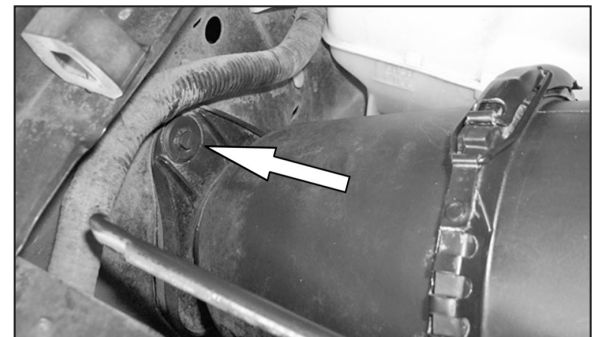

8. Release the push clip that secures the air box onto the vehicle.



9. Pull firmly up on the air box to remove from vehicle.
NOTE: K&N Engineering, Inc., recommends that customers do not discard factory air intake.

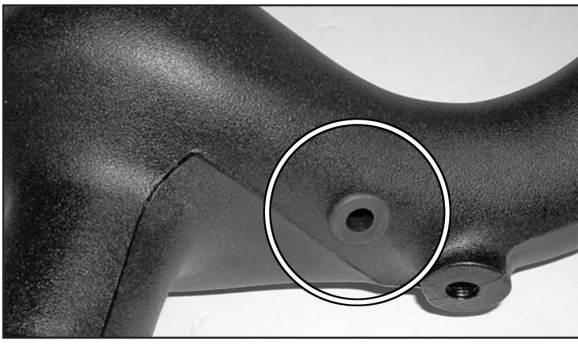

10. Install the provided grommet into the new K&N intake tube as shown.



11. Install the vent fitting into the K&N intake tube as shown.

NOTE: Plastic NPT fittings are easy to cross thread. Install the vent fitting "hand" tight, then turn it two complete turns with a wrench.

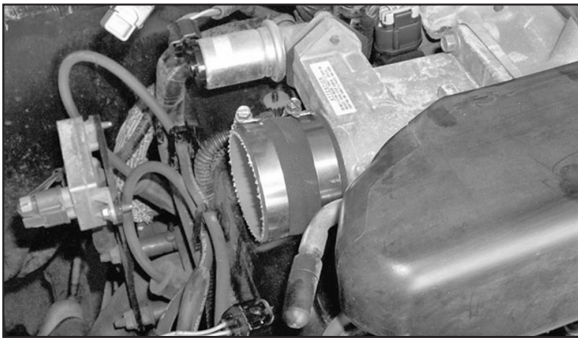

12. Install the provided silicone hose onto the throttle body with the provided hose clamps.



13. Assemble the saddle bracket onto the provided bracket as shown.

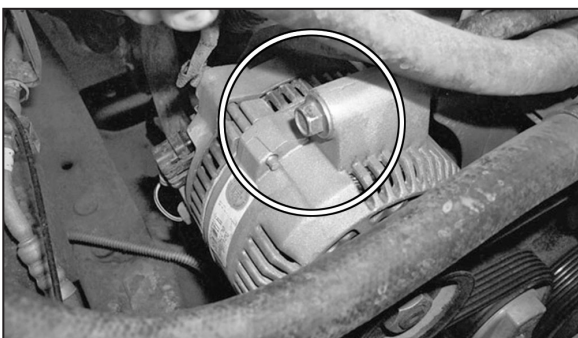

14. Remove the bolt that retains the alternator onto the motor.

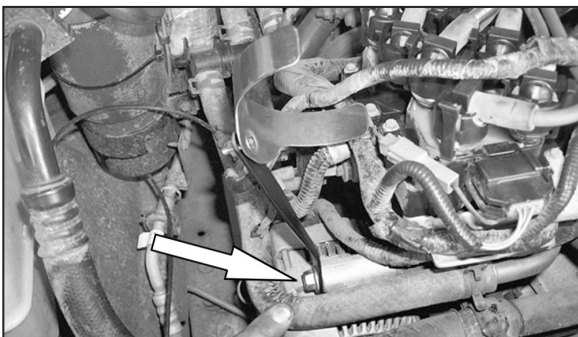

15. Install the saddle bracket assembly onto the alternator with the bolt that was removed in the previous step.

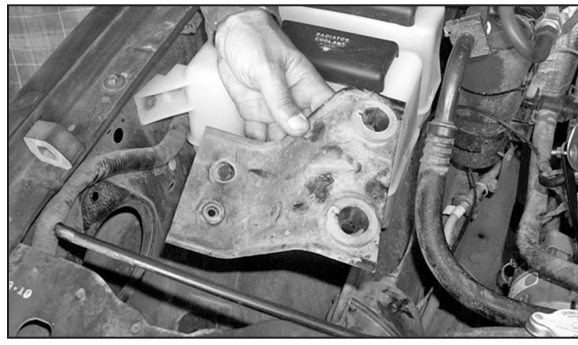

16. Remove the two bolts that retain the air box mounting bracket to the vehicle then remove bracket from vehicle.

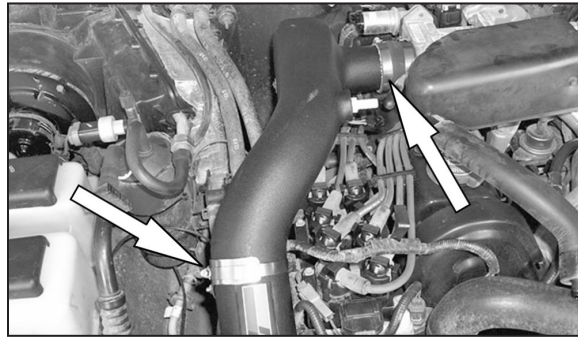

17. Install the new K&N intake tube onto the vehicle and then tighten the provided hose clamps at the throttle body and saddle bracket.

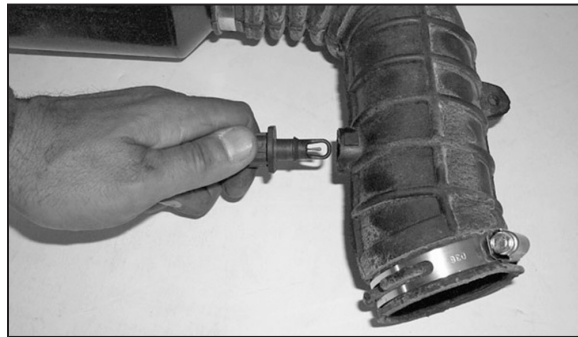

18. Remove the air temp. sensor from the stock intake tube as shown.



19. Install the air temp. sensor into the new K&N intake tube as shown.



20. Reconnect the air temp. electrical connection as shown.



21. Remove the crank case vent hose from the valve cover as shown.

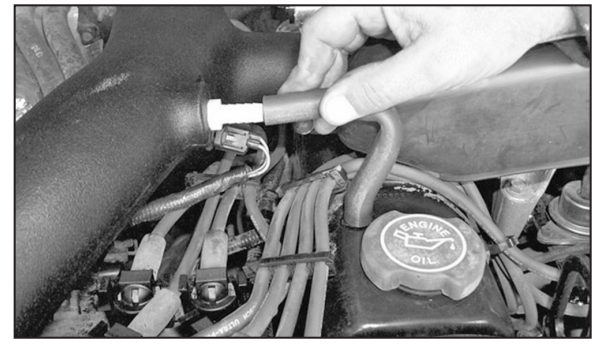

22. Connect the new silicone hose onto the valve cover and intake tube as shown.

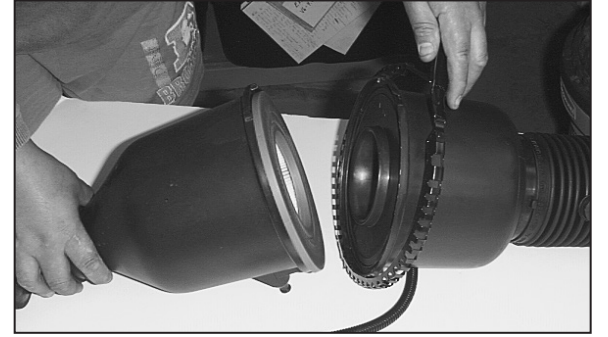

23. Open the air cleaner assembly and isolate the mass air sensor assembly.



24. Slide the rubber grommet back and disconnect the primary mass air sensor electrical connection, using a flat blade screwdriver.

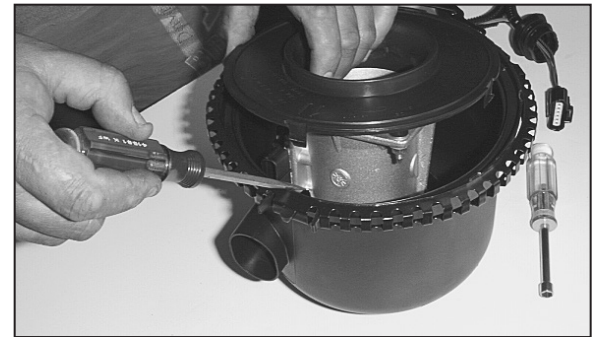

25. Using a flat blade screwdriver, push in and release the four clips that retain the mass air sensor retaining plate.



26. Using a pair of small vise grips or pliers, hold the stud while using a 10mm wrench to loosen the nuts, then remove the mass air sensor from the retaining plate.



27. Assemble the heat shield and filter adapter onto the mass air sensor with the provided hardware.



28. Install the edge trim onto the heat shield as shown. Trim if needed.

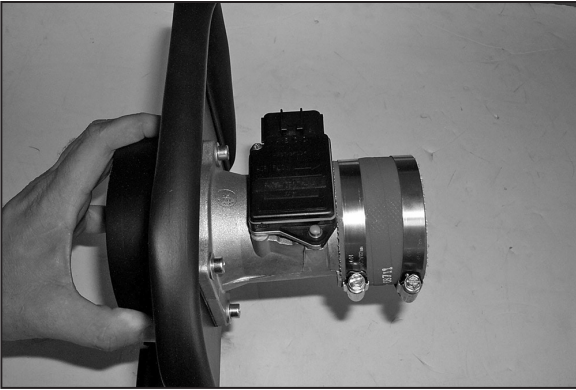

29. Install the silicone hose onto the mass air sensor with the provided hose clamps.

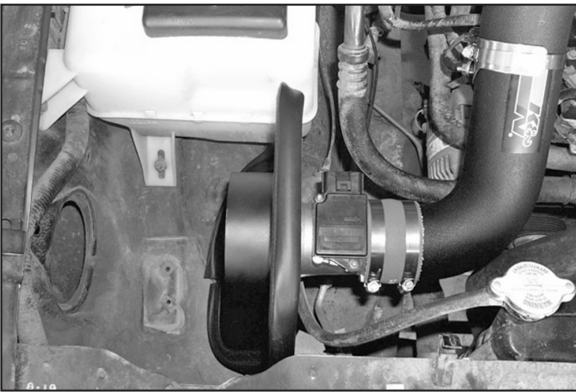

30. Install the mass air assembly onto the new intake tube then tighten the hose clamp.



31. Install the K&N Filtercharger onto the mass air assembly as shown.

NOTE: Drycharger® air filter wrap; part # RF-1037DK is available to purchase separately. To learn more about Drycharger® filter wraps or look up color availability please visit <http://www.knfilters.com>.

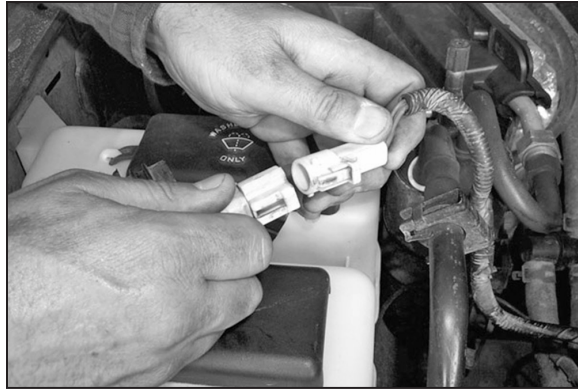

32. Connect the mass air pigtail to the main wire loom as shown.

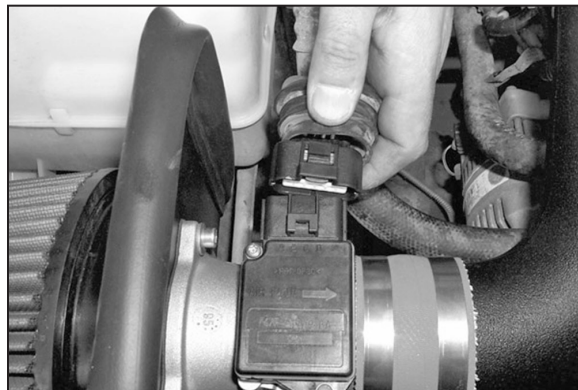

33. Reconnect the mass air electrical sensor as shown.

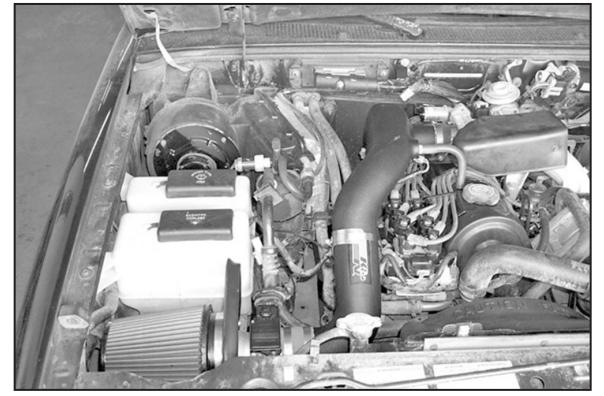

34. Reconnect the vehicle's negative battery cable. Double check to make sure everything is tight and properly positioned before starting the vehicle.

35. The C.A.R.B. exemption sticker, (attached), must be visible under the hood so that an emissions inspector can see it when the vehicle is required to be tested for emissions. California requires testing every two years, other states may vary.

36. It will be necessary for all K&N® high flow intake systems to be checked periodically for realignment, clearance and tightening of all connections. Failure to follow the above instructions or proper maintenance may void warranty.

ROAD TESTING:

1. Start the engine with the transmission in neutral or park, and the parking brake engaged. Listen for air leaks or odd noises. For air leaks secure hoses and connections. For odd noises, find cause and repair before proceeding. This kit will function identically to the factory system except for being louder and much more responsive.

2. Test drive the vehicle. Listen for odd noises or rattles and fix as necessary.

3. If road test is fine, you can now enjoy the added power and performance from your kit.

4. K&N Engineering, Inc., requires cleaning the intake system's air filter element every 100,000 miles. When used in dusty or off-road environments, our filters will require cleaning more often. We recommend that you visually inspect your filter once every 25,000 miles to determine if the screen is still visible. When the screen is no longer visible some place on the filter element, it is time to clean it. To clean and re-oil, purchase our filter Recharger® service kit, part number 99-5050 or 99-5000 and follow the easy instructions.

INTAKE SYSTEMS FOR VEHICLES LISTED ARE 50 STATE LEGAL. SEE KNFILTERS.COM FOR CARB STATUS ON EACH PART FOR A SPECIFIC VEHICLE.