



FUEL INJECTION PERFORMANCE KIT FIPIK

INTAKE SYSTEMS FOR VEHICLES LISTED ARE 50 STATE LEGAL. SEE KNFILTERS.COM FOR CARB STATUS ON EACH PART FOR A SPECIFIC VEHICLE.

INSTALLATION INSTRUCTIONS

57-3012

SATURN

1991-96 SC / SC2 / SL2 / SW2

L4-1.9L Twin Cam

(except TLEV Models)

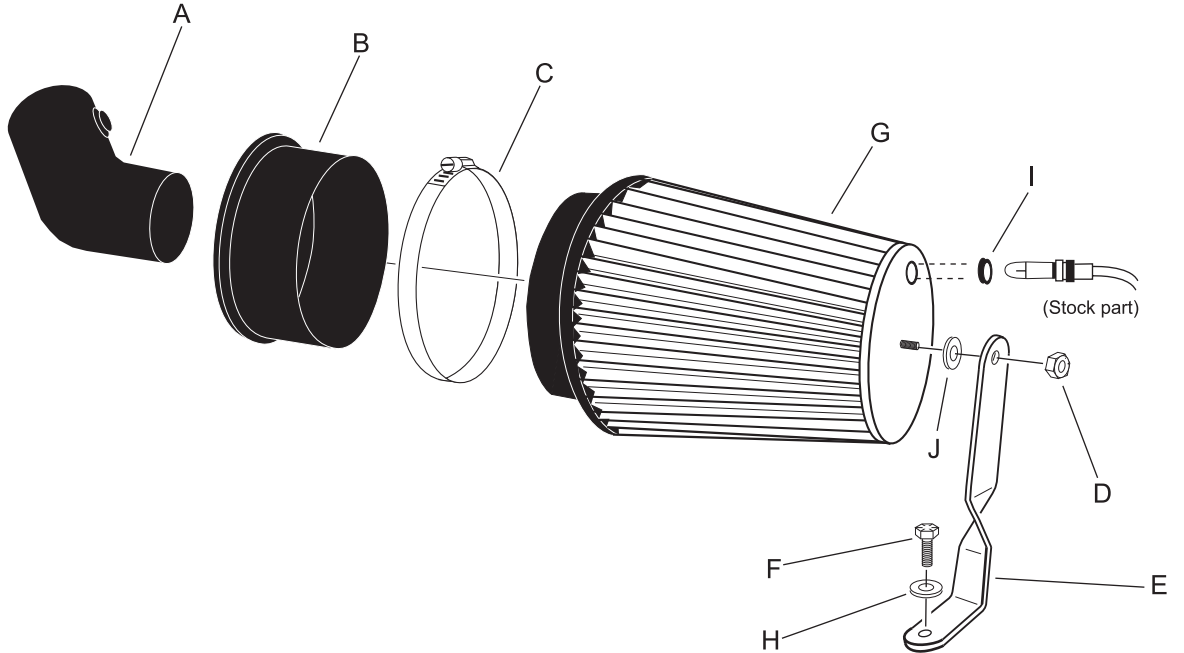

TOOLS NEEDED:

- Pair of pliers
- Pair of vise grips
- 13mm box wrench
- 10mm socket w/long extension
- Flat blade screwdriver
- 7/16" socket

PARTS LIST:

Description	Qty.	Part #	Description	Qty.	Part #	Description	Qty.	Part #
A. Intake Tube	1	08860	E. Bracket	1	07087	I. Rubber Grommet	1	08090
B. Velocity Ring	1	21538-1	F. 6mm Bolt	1	07863	J. 1/4" Flat Washer	1	08271
C. Hose Clamp # 64	1	08648	G. Air Filter	1	RF-1018			
D. 1/4-20 Nylock Nut	1	07517	H. 6mm Wave Washer	1	08174			

NOTE: FAILURE TO FOLLOW INSTALLATION INSTRUCTIONS AND NOT USING THE PROVIDED HARDWARE MAY DAMAGE THE INTAKE TUBE, THROTTLE BODY AND ENGINE.

TO START:



1. Turn off the ignition and disconnect the negative battery cable.



2. Loosen the hose clamp and remove the intake tube from the airbox.

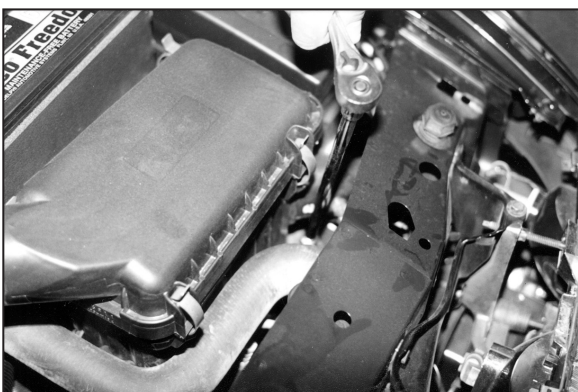

3. Using a 10mm socket, loosen and remove the three bolts that secure the airbox assembly.

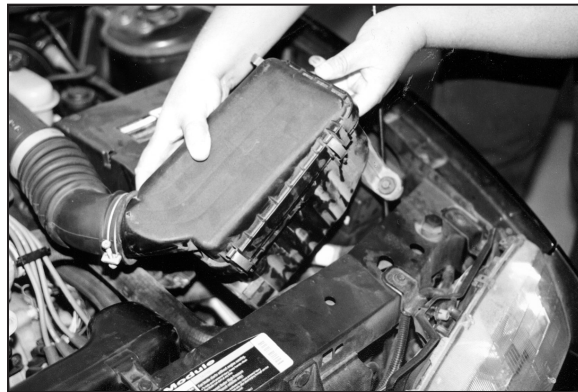

4a. On 91-94 models, remove the complete airbox assembly.

NOTE: K&N recommends that customers do not discard their factory air intake.



4b. On 95-96 models, disconnect the air temperature sensor electrical connection before removing the airbox assembly as shown.



5. Remove the push clip(s) that secure the air inlet tube/resonator to the radiator support.

NOTE: On 95-96 models, you will not be reinstalling the resonator

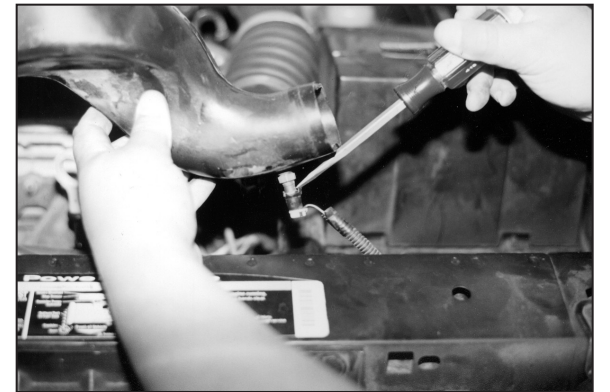

6. On 91-94 models, remove the air inlet tube and disconnect the air temperature sensor electrical connections.

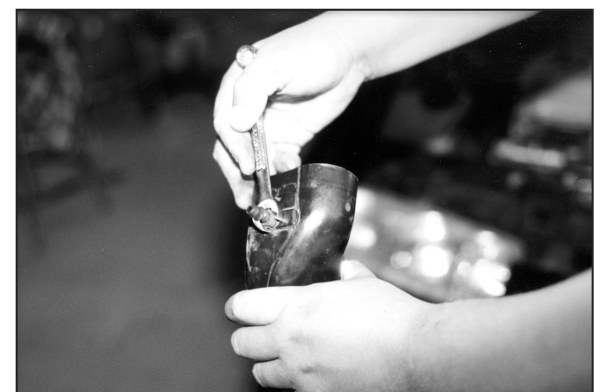

7a. On 91-94 models remove the air temperature sensor from the air inlet tube, then re-install the air inlet tube back onto the vehicle's radiator support.



7b. On 95-96 models, remove the air temperature sensor from the air inlet tube.

NOTE: It may be necessary to remove the air temperature sensor from the air inlet tube, using a pair of vise grips and a 13mm box end wrench.



8. Install the provided rubber grommet into the air filter top as shown above.

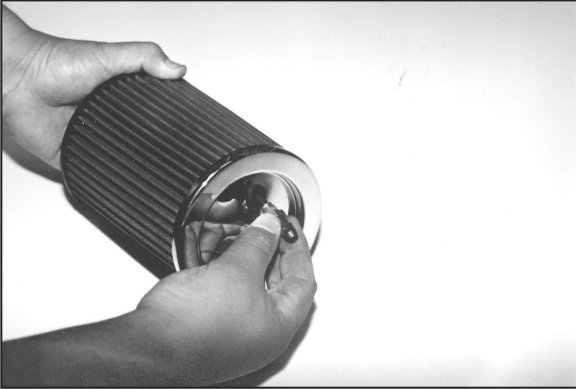

9. Insert the air temperature sensor into the rubber grommet.



10. Assemble the provided bracket onto the air filter element using the provided hardware as shown above.

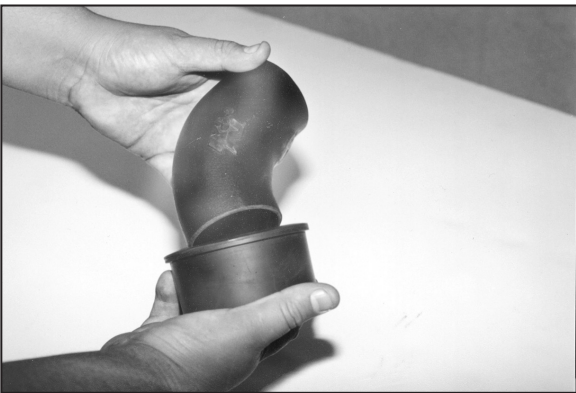

11. Install the provided velocity ring onto the K&N® intake tube as shown.



12. Assemble the tube assembly and the air filter element assembly as shown above.



13. Install the complete assembly into the the factory intake hose.

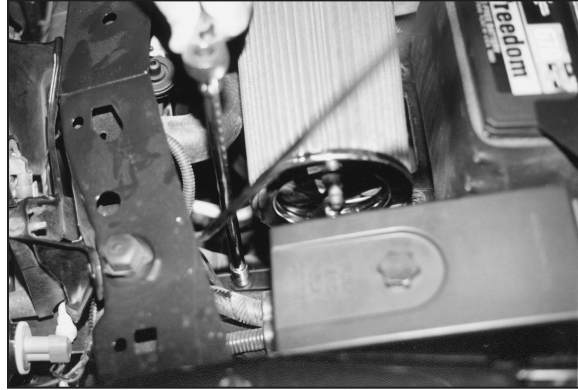

14. Secure the bracket to the existing airbox mounting hole using the provided bolt and washer. **NOTE: The air temperature sensor should be located approximately in the 12 o'clock position.**

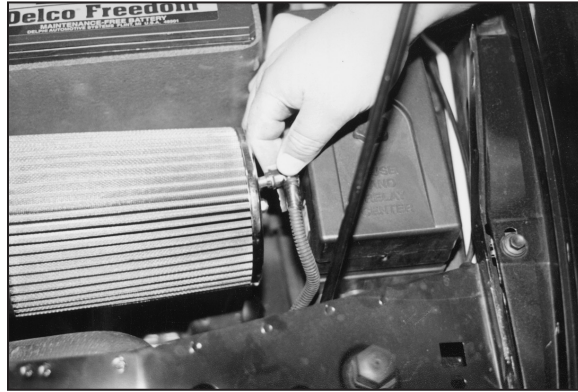

15. Re-connect the air temperature sensor electrical connection.

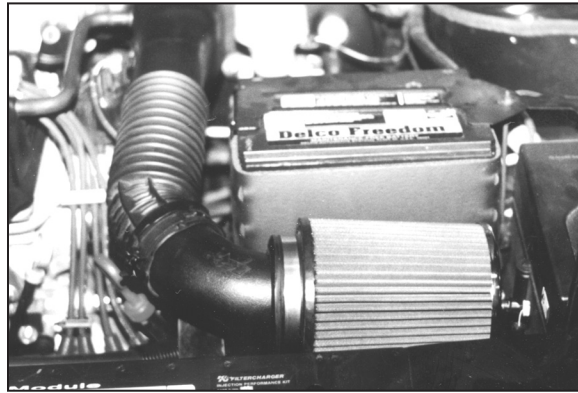

16. Reconnect the vehicle's negative battery cable. Double check to make sure everything is tight and properly positioned before starting the vehicle.

17. The C.A.R.B. exemption sticker, (attached), must be visible under the hood so that an emissions inspector can see it when the vehicle is required to be tested for emissions. California requires testing every two years, other states may vary.

18. It will be necessary for all K&N® high flow intake systems to be checked periodically for realignment, clearance and tightening of all connections. Failure to follow the above instructions or proper maintenance may void warranty.

ROAD TESTING:

1. Start the engine with the transmission in neutral or park, and the parking brake engaged. Listen for air leaks or odd noises. For air leaks secure hoses and connections. For odd noises, find cause and repair before proceeding. This kit will function identically to the factory system except for being louder and much more responsive.

2. Test drive the vehicle. Listen for odd noises or rattles and fix as necessary.

3. If road test is fine, you can now enjoy the added power and performance from your kit.

4. K&N Engineering, Inc., requires cleaning the intake system's air filter element every 100,000 miles. When used in dusty or off-road environments, our filters will require cleaning more often. We recommend that you visually inspect your filter once every 25,000 miles to determine if the screen is still visible. When the screen is no longer visible some place on the filter element, it is time to clean it. To clean and re-oil, purchase our filter Recharger® service kit, part number 99-5050 or 99-5000 and follow the easy instructions.

INTAKE SYSTEMS FOR VEHICLES LISTED ARE 50 STATE LEGAL. SEE KNFILTERS.COM FOR CARB STATUS ON EACH PART FOR A SPECIFIC VEHICLE.