



INTAKE SYSTEMS FOR VEHICLES LISTED ARE 50 STATE LEGAL. SEE KNFILTERS.COM FOR CARB STATUS ON EACH PART FOR A SPECIFIC VEHICLE.

INSTALLATION INSTRUCTIONS

57-3063 CHEVROLET / GMC 2007 SUBURBAN V8-6.0L

NOTE: This kit was not designed to fit vehicles with a body lift.

TOOLS NEEDED:

- Flat blade screw driver
- Ratchet
- Extension
- 10mm socket
- 1/2" socket
- 10mm wrench
- 3mm allen wrench
- 4mm allen wrench

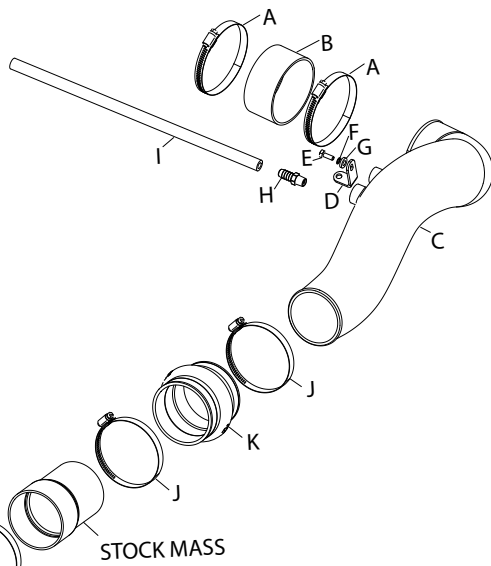
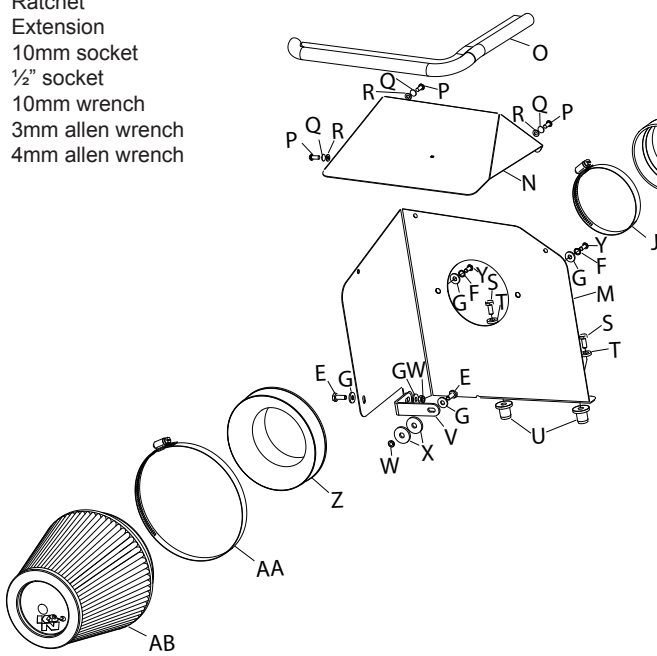

PARTS LIST:

Description	Qty.	Part #
A	2	08648
B	1	08625
C	1	087209
D	1	070812
E	3	07812
F	3	08198
G	6	08275
H	1	080022
I	1	08404
J	4	08628
K	1	08176
L	1	08618
M	1	07325
N	1	07326
O	1	102494
P	3	07734
Q	3	07724
R	3	08212
S	2	07777
T	2	08276
U	2	088002
V	1	010031
W	2	07553
X	2	08160
Y	2	07730
Z	1	27300
AA	1	08697
AB	1	RF-1042

NOTE: FAILURE TO FOLLOW INSTALLATION INSTRUCTIONS AND NOT USING THE PROVIDED HARDWARE MAY DAMAGE THE INTAKE TUBE, THROTTLE BODY AND ENGINE.

TO START:

1. Turn off the ignition and disconnect the negative battery cable.
NOTE: Disconnecting the negative battery cable erases pre-programmed electronic memories. Write down all memory settings before disconnecting the negative battery cable. Some radios will require an anti-theft code to be entered after the battery is reconnected. The anti-theft code is typically supplied with your owner's manual. In the event your vehicles' anti-theft code cannot be recovered, contact an authorized dealership to obtain your vehicles anti-theft code.



2. Disconnect the mass air sensor electrical connection as shown.



3. Pull up firmly on the engine cover to dislodge it from the mounting grommets and then remove the engine cover from the vehicle as shown.

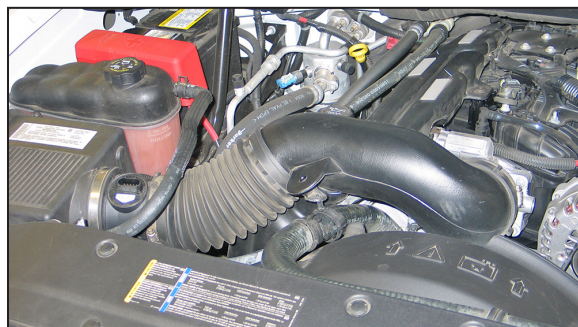

4. Loosen the two hose clamps that secure the intake tube to the throttle body and air box.



5. Unhook the upper radiator hose clip from the intake tube. Disconnect the crank case vent hose from the valve cover and then remove the intake hose from the vehicle.



6. Pull up firmly on the air box assembly to dislodge it from the mounting grommets and then remove the air box from the vehicle.
NOTE: K&N Engineering, Inc., recommends that customers do not discard factory air intake.

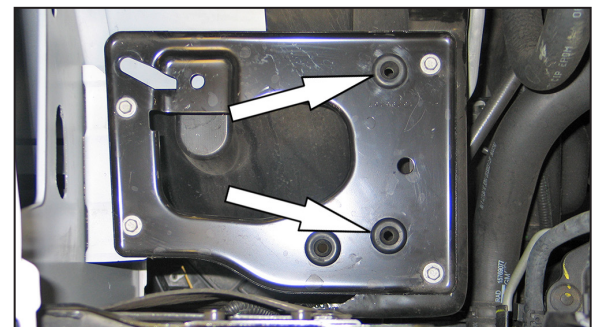

7. Remove the two air box mounting grommets shown.



8. Loosen the hose clamp that secures the mass air sensor to the air box and then remove the mass air sensor as shown.

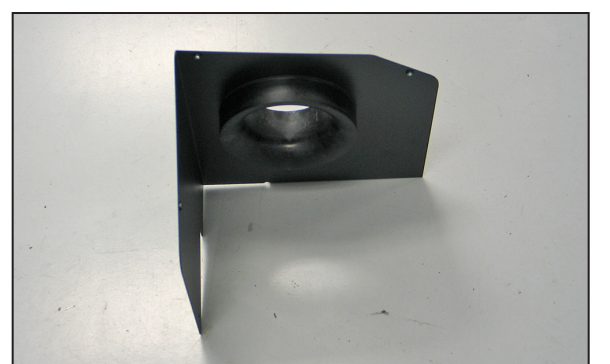

9. Install the supplied filter adapter onto the heat shield as shown and secure with the provided hardware.

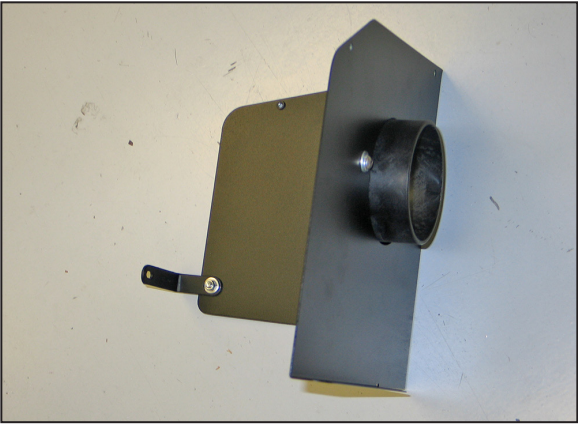

10. Install the supplied bracket (010031) onto the heat shield as shown and secure with the provided hardware.

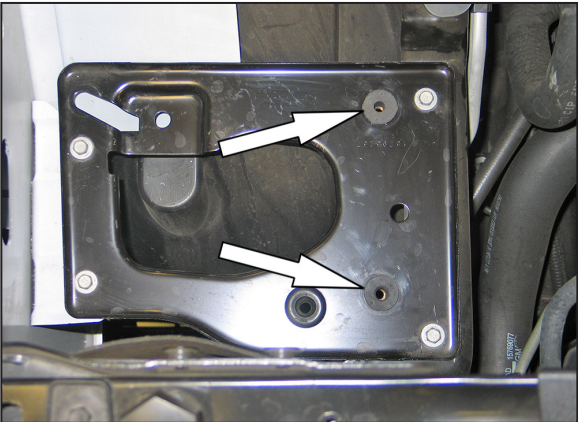

11. Install the two inserted nuts into the air box mounting plate as shown.

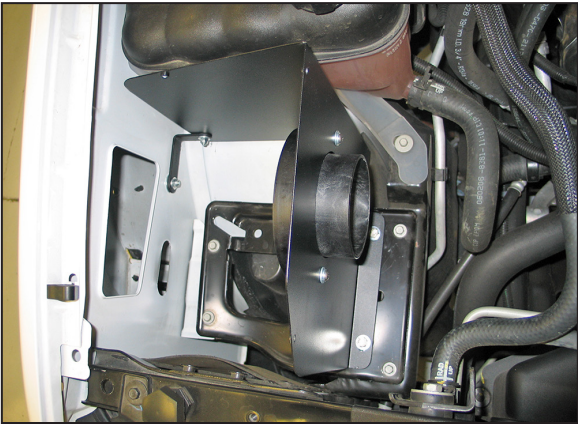

12. Install the heat shield assembly onto the air box mounting plate and secure to the inserted nuts with the hardware provided. Secure the heat shield mounting bracket to the inner fender with the hardware provided.

NOTE: The two large fender washers are to be placed on both sides of the inner fender sheet metal.



13. Install the 1/4" npt fitting into the K&N® intake tube as shown.

NOTE: Plastic NPT fittings are easy to cross thread. Install the vent fitting "hand" tight, then turn it two complete turns with a wrench.



14. Install the supplied bracket (070812) onto the K&N® intake tube as shown with the provided hardware.



15. Install the silicone hump hose (08176) onto the K&N® intake tube and secure with the provided hose clamp.

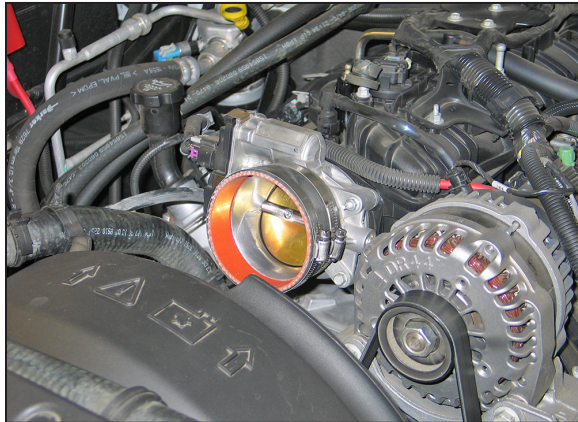

16. Install the supplied silicone hose (08625) onto the throttle body and secure with the provided hose clamp.

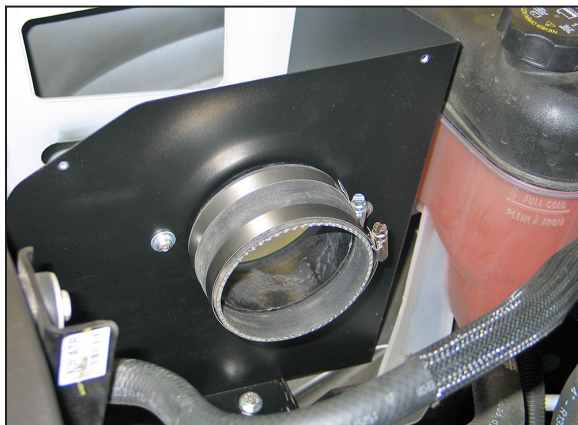

17. Install the provided silicone hose (08618) onto the filter adapter as shown and secure with the provided hose clamp.

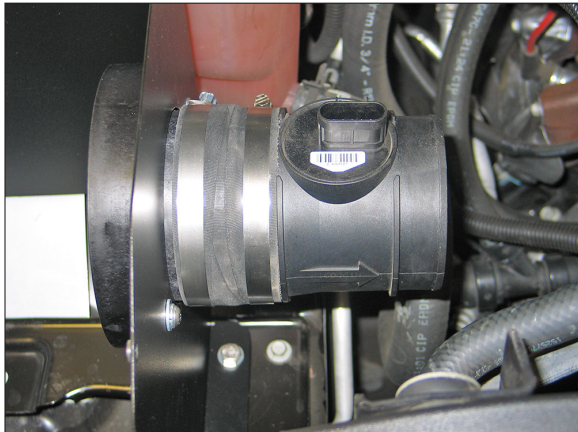

18. Install the mass air sensor into the silicone hose at the filter adapter and secure with the provided hose clamp.

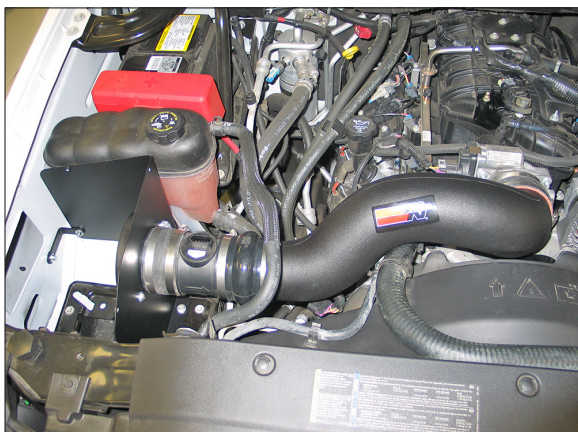

19. Install the K&N® intake tube assembly into the silicone hose at the throttle body and onto the mass air sensor as shown and secure with the provided hose clamps.

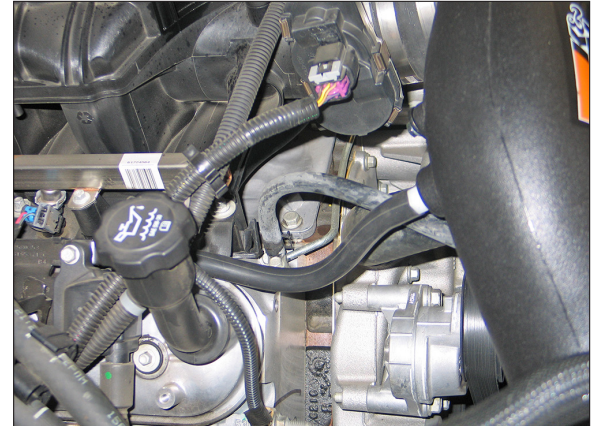

20. Install the supplied crank case vent hose onto the valve cover fitting and then connect to the npt fitting in the K&N® intake tube.

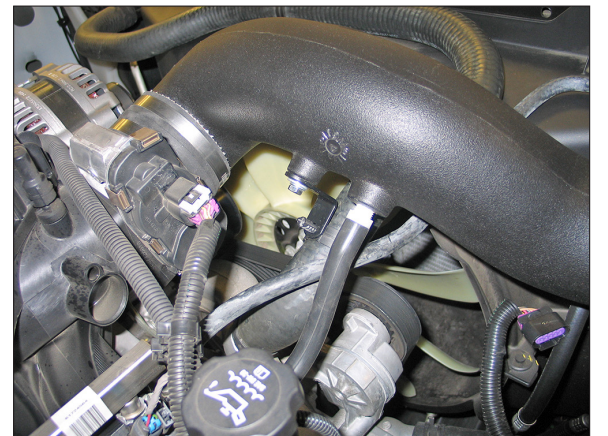

21. Clip the upper radiator hose mount into the bracket install on the K&N® intake tube.



22. Install the K&N® air filter to the air filter adapter and secure with the supplied hose clamp.

NOTE: Drycharger® air filter wrap; part # RF-1042DK is available to purchase separately. To learn more about Drycharger® filter wraps or look up color availability please visit <http://www.knfilters.com>.



23. Install the edge trim onto the heat shield lid as shown.

NOTE: Some trimming of the edge trim may be necessary.

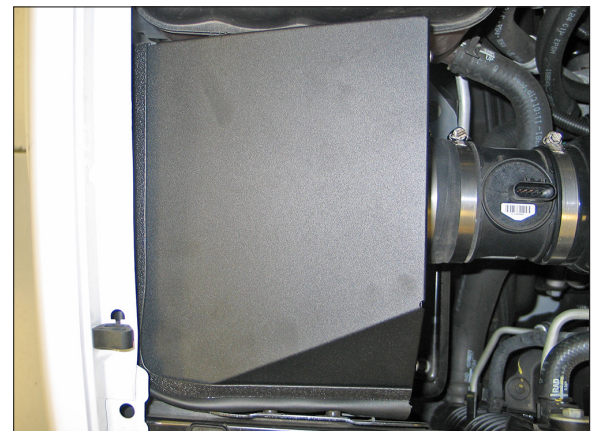

24. Install the heat shield lid onto the heat shield and secure with the provided hardware.

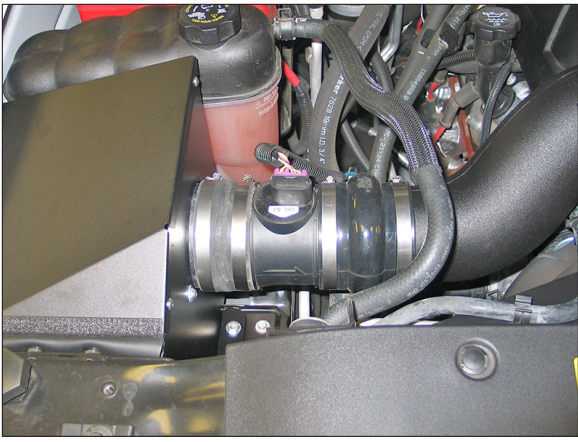

25. Reconnect the mass air sensor electrical connection.



26. Reinstall the engine cover.

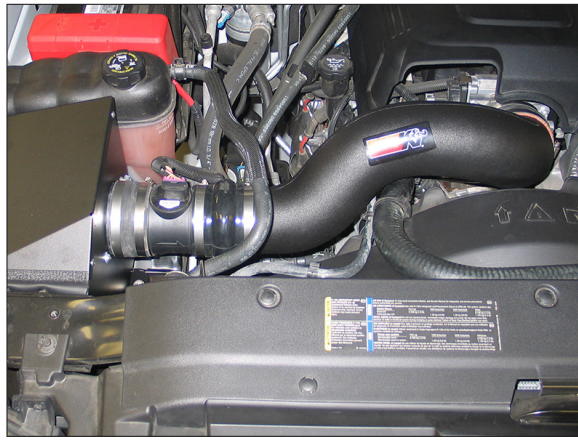

27. Reconnect the vehicle's negative battery cable. Double check to make sure everything is tight and properly positioned before starting the vehicle.

28. The C.A.R.B. exemption sticker, (attached), must be visible under the hood so that an emissions inspector can see it when the vehicle is required to be tested for emissions. California requires testing every two years, other states may vary.

29. **NOTE:** Most General Motors vehicles have the Vehicle Emissions Certification Information (VECI) label affixed to the air filter box. In order to be compliant with California emissions laws, the label **MUST** remain in the engine compartment. If the Vehicle Emission Control Information label is removed during modification, a new replacement label must be obtained and installed in a readily visible position in the engine compartment. The label shall not be affixed to any equipment which is easily detached from the vehicle. We recommend that the label is affixed to the underside of the hood adjacent to the hood latch. The label is Vehicle Identification Number dependent and can be ordered from the vehicle dealership. In order to receive the proper decal please bring your VIN with you. Failure to have the VECI under the hood may result in failure of a pre-registration smog test.

30. It will be necessary for all K&N® high flow intake systems to be checked periodically for realignment, clearance and tightening of all connections. Failure to follow the above instructions or proper maintenance may void warranty.

ROAD TESTING:

1. Start the engine with the transmission in neutral or park, and the parking brake engaged. Listen for air leaks or odd noises. For air leaks secure hoses and connections. For odd noises, find cause and repair before proceeding. This kit will function identically to the factory system except for being louder and much more responsive.

2. Test drive the vehicle. Listen for odd noises or rattles and fix as necessary.

3. If road test is fine, you can now enjoy the added power and performance from your kit.

4. K&N Engineering, Inc., requires cleaning the intake system's air filter element every 100,000 miles. When used in dusty or off-road environments, our filters will require cleaning more often. We recommend that you visually inspect your filter once every 25,000 miles to determine if the screen is still visible. When the screen is no longer visible some place on the filter element, it is time to clean it. To clean and re-oil, purchase our filter Recharger® service kit, part number 99-5050 or 99-5000 and follow the easy instructions.

INTAKE SYSTEMS FOR VEHICLES LISTED ARE 50 STATE LEGAL. SEE KNFILTERS.COM FOR CARB STATUS ON EACH PART FOR A SPECIFIC VEHICLE.