



INTAKE SYSTEMS FOR VEHICLES LISTED ARE 50 STATE LEGAL. SEE KNFILTERS.COM FOR CARB STATUS ON EACH PART FOR A SPECIFIC VEHICLE.

# INSTALLATION INSTRUCTIONS

57-3067

CHEVROLET / GMC

2007-08 Silverado 2500 HD / 3500 HD

2007-08 Sierra 2500 HD / 3500 HD

V8-6.0L

NOTE: This kit was not designed to fit vehicles with a body lift.

**TOOLS NEEDED:**

- Ratchet
- Extension
- 1/2" Socket
- 10mm Socket
- 5/8" Wrench
- 10mm Wrench
- Flat Blade Screwdriver
- 4mm Allen Wrench
- 3mm Allen Wrench

**PARTS LIST:**

Description	Qty.	Part #	Description	Qty.	Part #	Description	Qty.	Part #
A Hose Clamp #60 SS	3	08628	J Heat Shield	1	07326	S Washer; 1"D X 1/4 Hole Fender	2	08160
B Hose; 3-1/2"ID to 4"ID, Angled, Silicone	1	084053	K Heat Shield	1	07325	T Bracket; "L" Small, Stl., FB/PC	1	010031
C Hose Clamp #56	3	08620	L Washer; 1/4" Lock, ZN	2	08198	U Nut; 6mm Nylock, Hex, SS	2	07512
D Intake Tube	1	087225	M Washer; 5mm Internal Star Cut Lock	3	07724	V Insert; 5/16-18 X .600od X .730L	2	088002
E Vent; Strt., 3/8"Hose, 1/4"NPT, Plas.	1	08047	N Washer; 5mm Flat, SS.	3	08212	W Washer; 5/16"ID X 5/8"OD, Flat	2	08276
F Hose; 3/8"ID X 12"L, Silicone	1	08412	O Bolt; 5mm-.80 X 16mm Hex.	3	22204	X Bolt; 5/16"- 18 X 1"L, SS	2	07777
G Hose; 3-1/2"ID to 3-5/8"ID X 3-3/8"L	1	084056	P Washer; 1/4"ID X 5/8"OD - SAE	5	08275	Y Adapter; #454	1	27300
H Hose; 4.0"ID X 3.824"ID X 2.0" L, Tprd.	1	08618	Q Bolt; 6mm-1.00 X 16mm, SS	3	07812	Z Hose Clamp #104	1	08697
I Edge Trim 20"	1	102494	R Bolt; M6 X 1.00" X 20mm Hex, SS	1	07795	AA Air Filter	1	RF-1042

NOTE: FAILURE TO FOLLOW INSTALLATION INSTRUCTIONS AND NOT USING THE PROVIDED HARDWARE MAY DAMAGE THE INTAKE TUBE, THROTTLE BODY AND ENGINE.

**TO START:**

1. Turn off the ignition and disconnect the negative battery cable.  
**NOTE: Disconnecting the negative battery cable erases pre-programmed electronic memories. Write down all memory settings before disconnecting the negative battery cable. Some radios will require an anti-theft code to be entered after the battery is reconnected. The anti-theft code is typically supplied with your owner's manual. In the event your vehicles' anti-theft code cannot be recovered, contact an authorized dealership to obtain your vehicles anti-theft code.**



2. Lift up the engine cover and remove from the engine as shown



3. Disconnect the mass air sensor electrical connection.



4. Disconnect the crank case vent hose from the valve cover vent port.



5. Loosen the hose clamp that secures the stock intake tube to the mass air sensor.

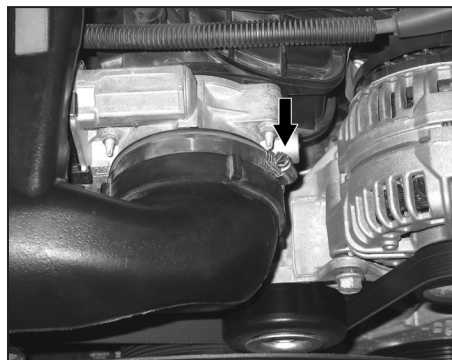

6. Loosen the hose clamp that secures the stock intake tube to the throttle body.



7. Unhook the stock intake tube from the mounting grommet and the upper radiator hose. Then remove the stock intake tube from the vehicle as shown.

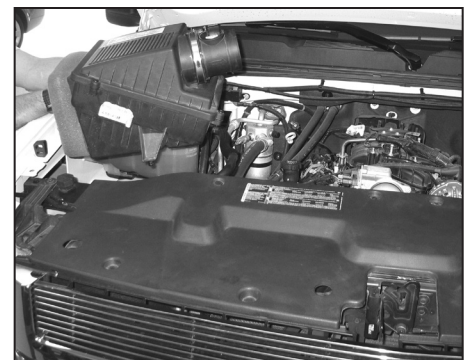

8. Firmly lift up the air box assembly to dislodge it from the mounting grommets. Then remove the air box assembly from the vehicle.  
**NOTE: K&N Engineering, Inc., recommends that customers do not discard factory air intake.**

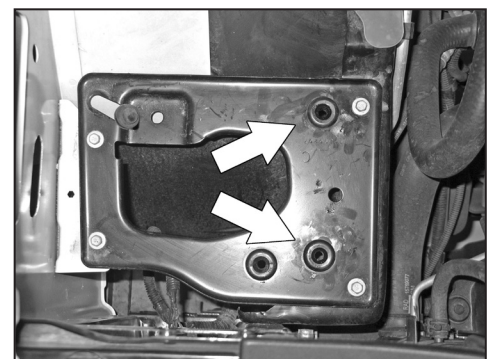

9. Remove the two pictured air box mounting grommets from the air box mounting plate.

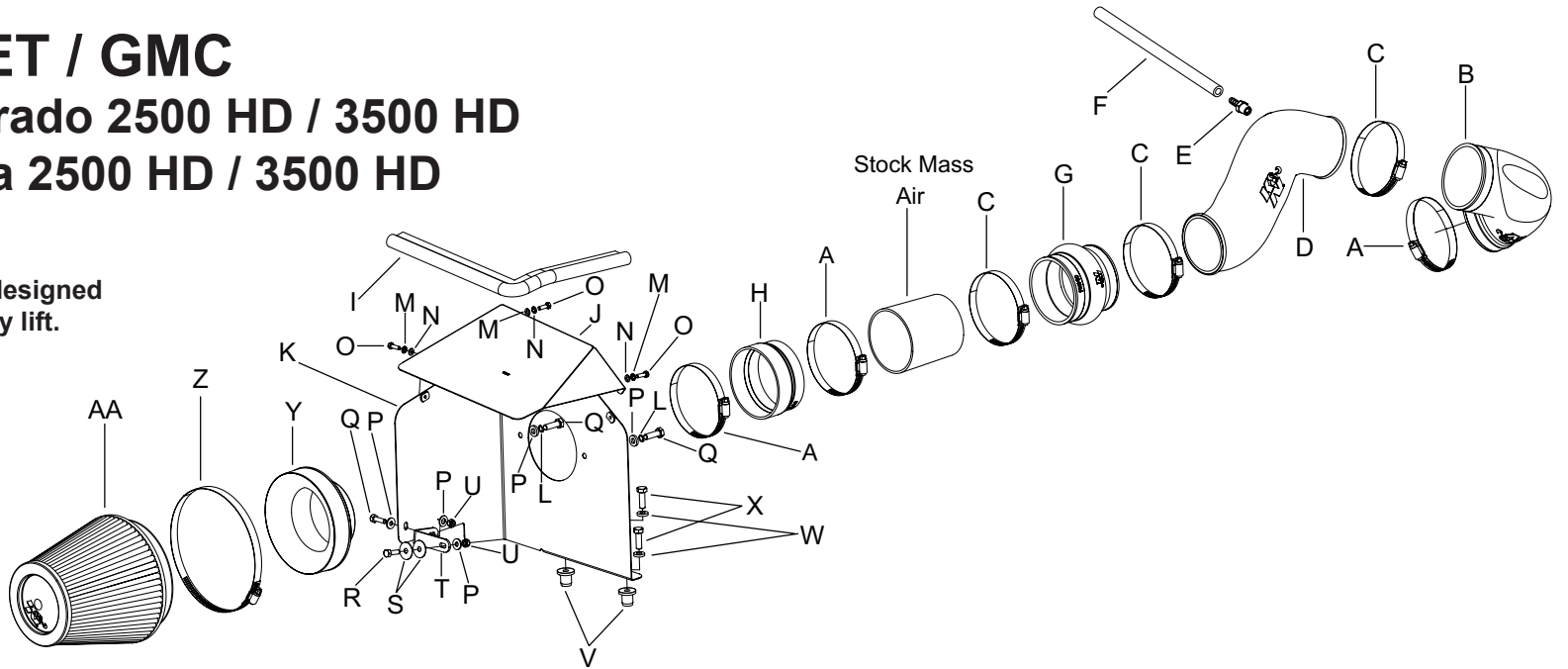

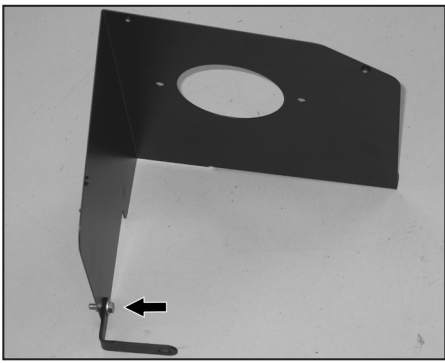

10. Using the provided hardware, mount the heat shield mounting bracket (010031) onto the heat shield as shown.

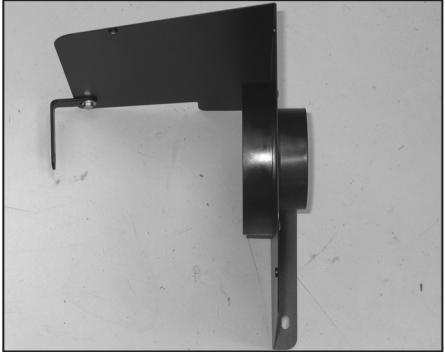

11. Using the provided hardware, install the filter adapter onto the heat shield as shown.

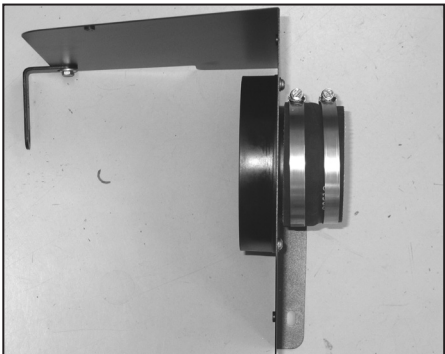

12. Install the silicone hose (08618) onto the filter adapter and secure with the provided hose clamp.

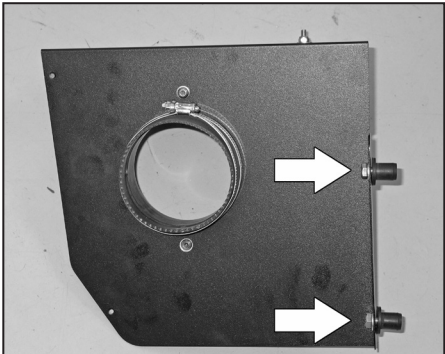

13. Install the two inserted nuts onto the heat shield as shown using the provided hardware.  
**NOTE: Do not completely tighten at this time.**



14. Loosen the hose clamp that secures the mass air sensor to the air box. Then remove the mass air sensor as shown.

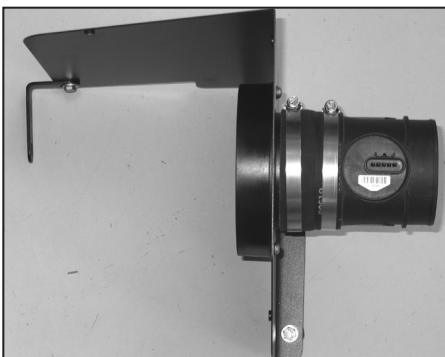

15. Install the mass air sensor onto the heat shield assembly and secure with the provided hose clamp.

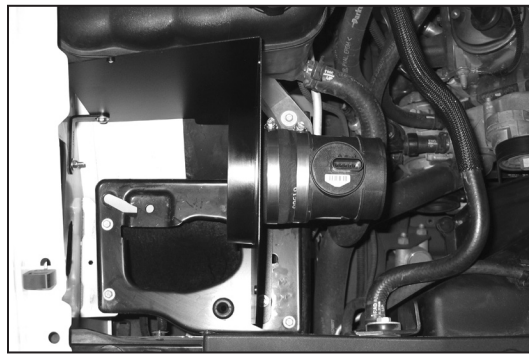

16. Install the heat shield assembly into the vehicle so that the inserted nuts fit into the air box mounting grommet holes. Then tighten the mounting bolts.

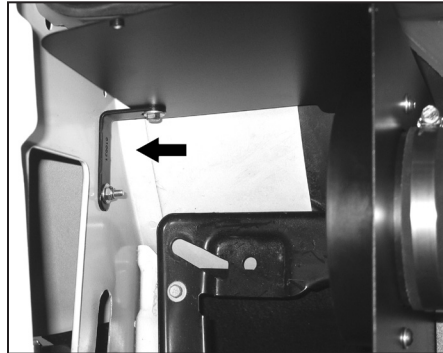

17. Secure the heat shield mounting bracket to the inner fender with the provided hardware.



18. Install the silicone hump hose (084056) onto the mass air sensor and secure with the provided hose clamp.



19. Install the 90° silicone hose (084053) onto the throttle body and secure with the provided hose clamp.  
**NOTE: Do not completely tighten at this time.**



20. Install the 1/4"npt fitting into the K&N® intake tube as shown.  
**NOTE: Plastic NPT fittings are easy to cross thread. Install the vent fitting "hand" tight, then turn it two complete turns with a wrench.**



21. Install the K&N® intake tube into the throttle body and mass air sensor silicone hoses. Secure with the provided hose clamps.  
**NOTE: The silicone hose at the throttle body will need to be adjusted for proper fit before tightening all of the hose clamps.**

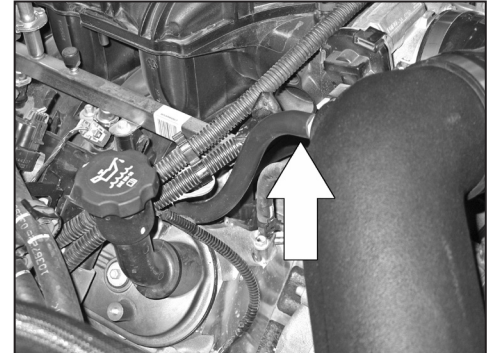

22. Install the supplied silicone hose onto the 1/4"npt fitting installed into the K&N® intake tube and then attach the open end onto the crank case vent port on the valve cover.

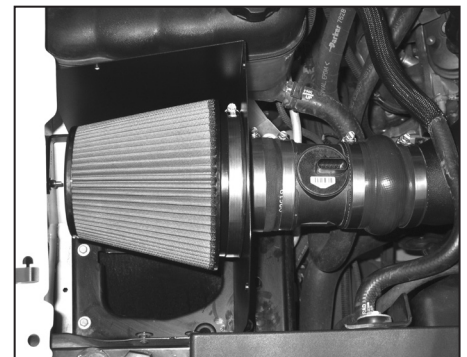

23. Install the K&N® air filter onto the filter adapter and secure with provided hose clamp.



24. Install the edge trim onto the air box lid as shown.  
**NOTE: Some trimming of the edge trim may be necessary.**

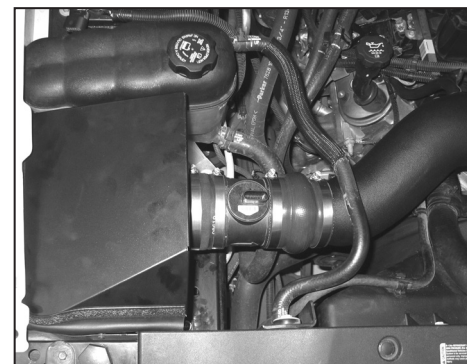

25. Install the air box lid and secure with the provided hardware.



26. Install the engine cover back onto the engine.

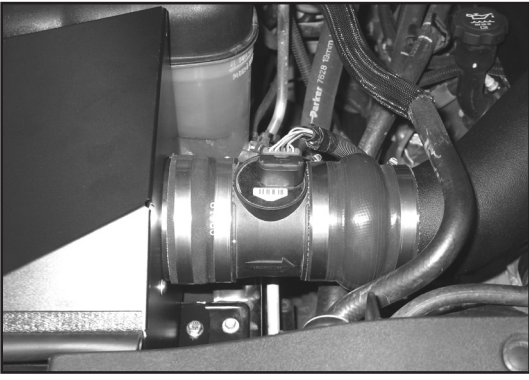

27. Reconnect the mass air sensor electrical connection.



28. Reconnect the vehicles negative battery cable. Double check to make sure everything is tight and properly positioned before starting the vehicle.

29. The C.A.R.B. exemption sticker, (attached), must be visible under the hood so that an emissions inspector can see it when the vehicle is required to be tested for emissions. California requires testing every two years, other states may vary.

30. **NOTE:** Most General Motors vehicles have the Vehicle Emissions Certification Information (VECI) label affixed to the air filter box. In order to be compliant with California emissions laws, the label **MUST** remain in the engine compartment. If the Vehicle Emission Control Information label is removed during modification, a new replacement label must be obtained and installed in a readily visible position in the engine compartment. The label shall not be affixed to any equipment which is easily detached from the vehicle. We recommend that the label is affixed to the underside of the hood adjacent to the hood latch. The label is Vehicle Identification Number dependent and can be ordered from the vehicle dealership. In order to receive the proper decal please bring your VIN with you. Failure to have the VECI under the hood may result in failure of a pre-registration smog test.

31. It will be necessary for all K&N® high flow intake systems to be checked periodically for realignment, clearance and tightening of all connections. Failure to follow the above instructions or proper maintenance may void warranty.

#### ROAD TESTING:

1. Start the engine with the transmission in neutral or park, and the parking brake engaged. Listen for air leaks or odd noises. For air leaks secure hoses and connections. For odd noises, find cause and repair before proceeding. This kit will function identically to the factory system except for being louder and much more responsive.

2. Test drive the vehicle. Listen for odd noises or rattles and fix as necessary.

3. If road test is fine, you can now enjoy the added power and performance from your kit.

4. K&N Engineering, Inc., requires cleaning the intake system's air filter element every 100,000 miles. When used in dusty or off-road environments, our filters will require cleaning more often. We recommend that you visually inspect your filter once every 25,000 miles to determine if the screen is still visible. When the screen is no longer visible some place on the filter element, it is time to clean it. To clean and re-oil, purchase our filter Recharger® service kit, part number 99-5050 or 99-5000 and follow the easy instructions.

**INTAKE SYSTEMS FOR VEHICLES LISTED ARE 50 STATE LEGAL. SEE KNFILTERS.COM FOR CARB STATUS ON EACH PART FOR A SPECIFIC VEHICLE.**