



# AIRCHARGER™

## HIGH-FLOW INTAKE KITS

NOT LEGAL FOR SALE OR USE ON ANY POLLUTION CONTROLLED MOTOR VEHICLE IN CALIFORNIA OR STATES ADOPTING CALIFORNIA EMISSION PROCEDURES.

See knfilters.com for CARB status on each part for a specific vehicle

### INSTALLATION INSTRUCTIONS

## 63-2580

## FORD

## 2009-10 F-150

## V8-4.6L

Excludes 2 Valve Vin W vehicles

NOTE: This kit was not designed to fit vehicles with a body lift.

#### TOOLS NEEDED:

- Flat blade Screwdriver
- 4mm Allen Wrench
- 3mm Allen Wrench
- 5/8" Wrench
- T20 TORX

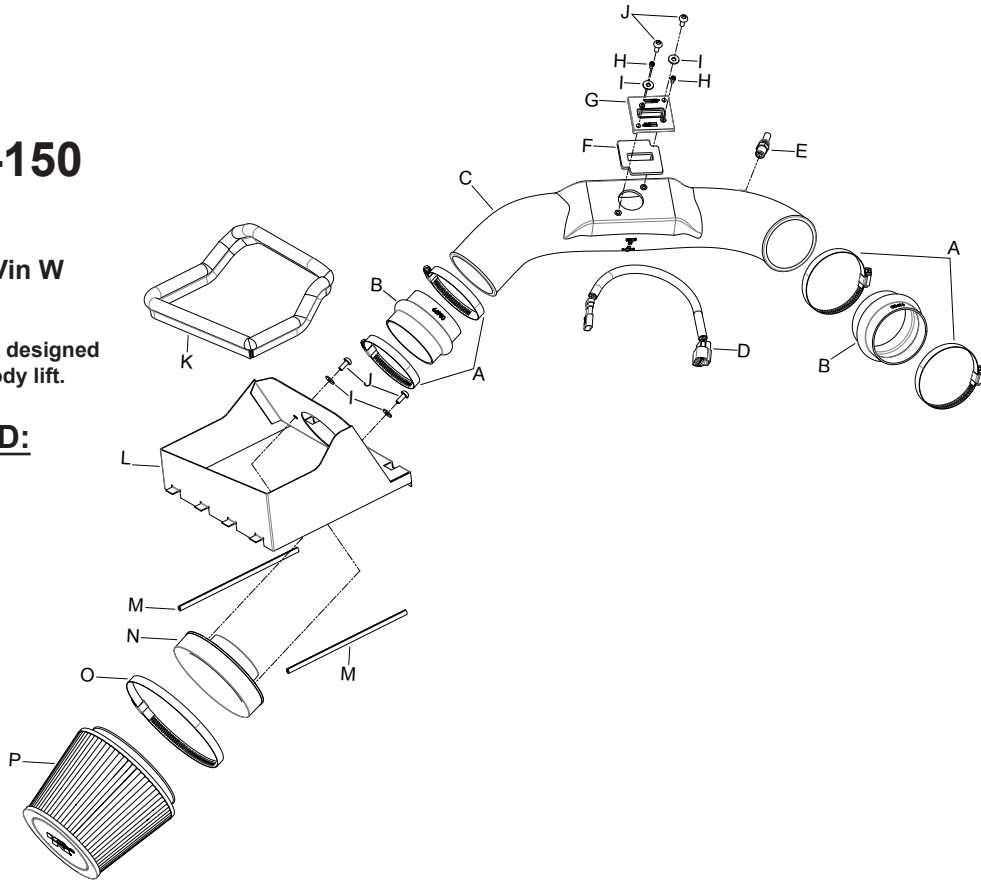

#### PARTS LIST:

Description	Qty.	Part #
A Hose Clamp #56	4	08620
B Hose; 3-1/2" ID X 2-1/2" L Hump	2	08699
C Intake Tube	1	087239
D MAF Extension Harness	1	21780
E Vent; Strt., 1/4" NPT To Quick Release	1	08938
F Gasket; 3/16 Poron	1	09069
G Adaptor; #420, Nylon 6/6 GF, Black	1	21515
H Bolt; M4 - 0.07 8MM, A/H Cap, SS	2	07733
I Washer; 6MM FLAT, SS	4	08269
J Bolt; M6 X 1.00 X 16MM, Buttonhead, SS	4	07730
K Edge Trim (35")	1	102471
L Heat Shield	1	074076
M Edge Trim (19")	1	102451
N Adapter; Universal, 6" Filter 3.5" Coupler	1	21512-1
O Hose Clamp # 104	1	08697
P Air Filter	1	RC-5173

**NOTE: FAILURE TO FOLLOW INSTALLATION INSTRUCTIONS AND NOT USING THE PROVIDED HARDWARE MAY DAMAGE THE INTAKE TUBE, THROTTLE BODY AND ENGINE.**

#### TO START:

1. Turn off the ignition and disconnect the negative battery cable.

**NOTE: Disconnecting the negative battery cable erases pre-programmed electronic memories. Write down all memory settings before disconnecting the negative battery cable. Some radios will require an anti-theft code to be entered after the battery is reconnected. The anti-theft code is typically supplied with your owner's manual. In the event your vehicles' anti-theft code cannot be recovered, contact an authorized dealership to obtain your vehicles anti-theft code.**

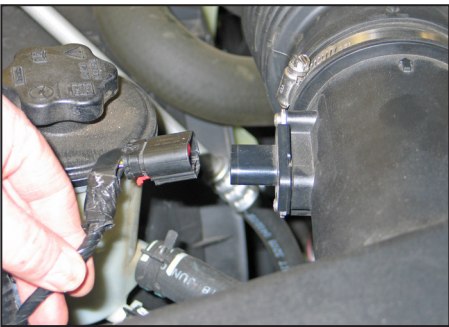

2. Release the red locking tab and then disconnect the mass air sensor electrical connection.



3. Release the green locking tab and then disconnect the crank case vent line from the intake tube as shown.

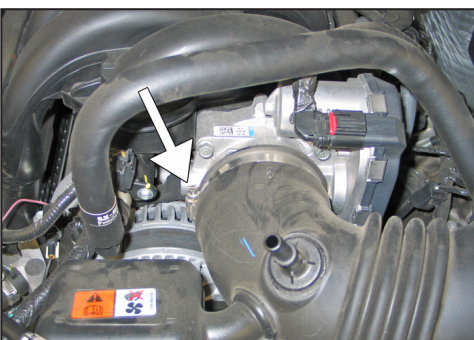

4. Loosen the hose clamp which secures the intake tube to the throttle body.

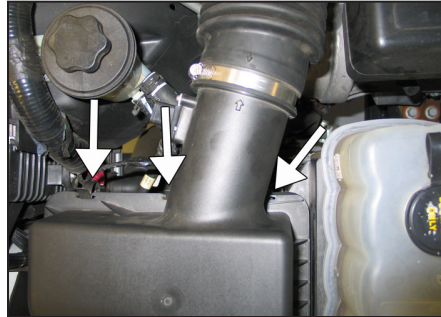

5. Release the three retaining clips that secure the upper air box to the lower air box.



6. Remove the upper air box housing and intake tube assembly from the vehicle.

**NOTE: K&N Engineering, Inc., recommends that customers do not discard factory air intake.**



7. Remove the air filter from the lower air box.

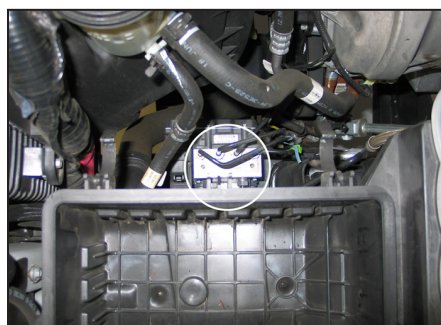

8. Remove the center upper air box retaining clip from the lower air box.

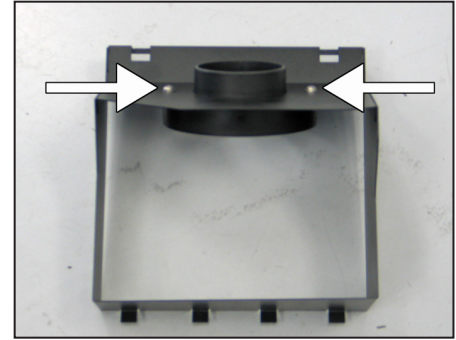

9. Install the K&N® filter adapter into the heat shield as shown and secure with the provided hardware.



10. Install the provided edge trim onto the heat shield as shown.

**NOTE: Some trimming of the edge trim will be necessary.**

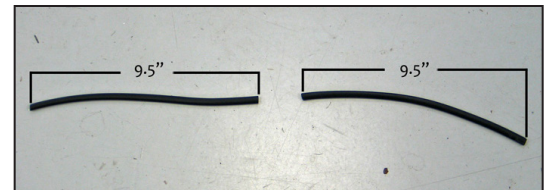

11. Cut the 19" section of small edge trim into two 9-1/2" lengths.

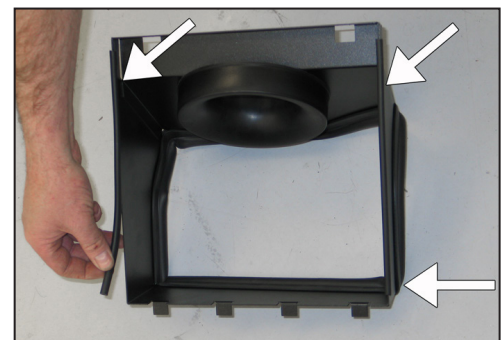

12. Install the two 9-1/2" lengths of small edge trim onto the bottom heat shield as shown.





13. Install the K&N® air filter onto the filter adapter and secure with the provided hose clamp.  
**NOTE: Drycharger® air filter wrap; part # RC-5173DK is available to purchase separately. To learn more about Drycharger® filter wraps or look up color availability please visit <http://www.knfilters.com>.**



14. Install the provided silicone hose (08699) onto the filter adapter as shown and secure with the provided hose clamp.

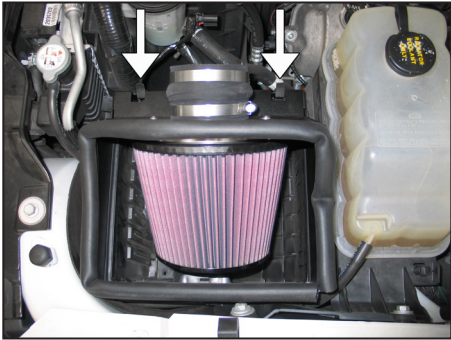

15. Install the completed heat shield / air filter assembly onto the lower air box and secure with the two factory air box retaining clips.

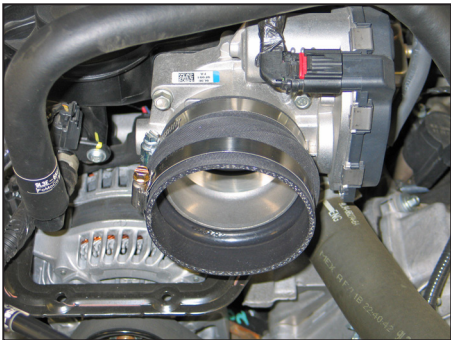

16. Install the provided silicone hose (08699) onto the throttle body and secure with the provided hose clamp.

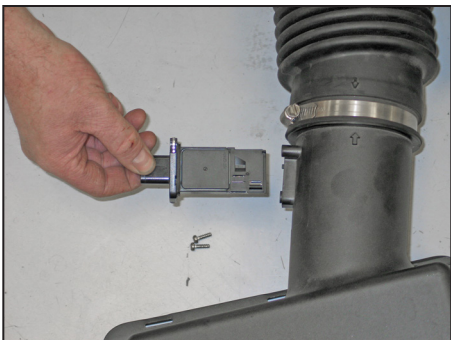

17. Remove the mass air sensor mounting bolts, then remove the mass air sensor from the factory air box.

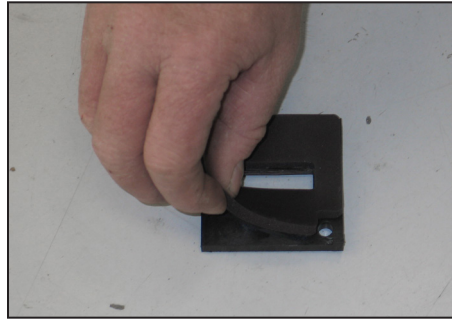

18. Install the provided gasket onto the K&N® mass air sensor adapter.

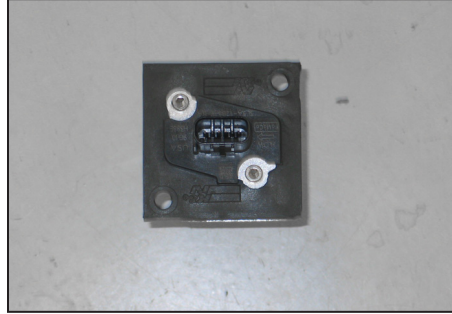

19. Install the mass air sensor into the mass air adapter and secure with the provided screws.

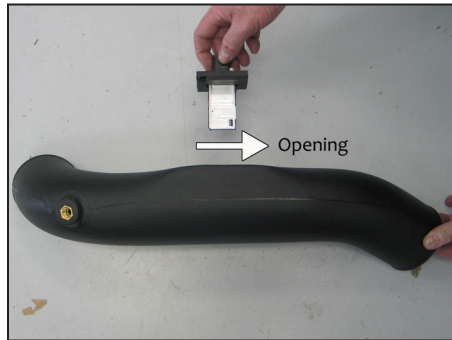

20. Install the mass air sensor assembly into the K&N® intake tube as shown.  
**NOTE: Be sure to insert the mass air sensor in the correct direction. The opening in the sensor should be pointing towards the air filter.**



21. Install the provided crank case vent fitting into the K&N® intake tube as shown.  
**NOTE: Plastic NPT fittings are easy to cross thread. Install the vent fitting "hand" tight, then turn it two complete turns with a wrench.**



22. Install the K&N® intake tube; insert the lower end into the silicone hose attached to the heat shield /air filter assembly. Attach the upper end of the intake tube to the silicone hose secured to the throttle body. Secure the intake tube with the provided hose clamps.

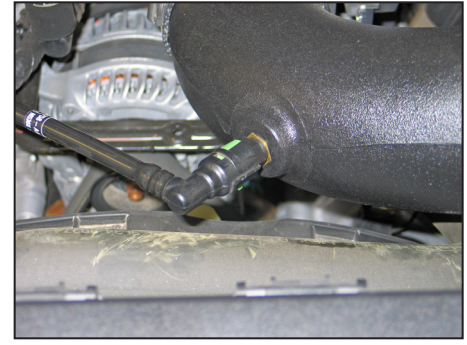

23. Rotate the crank case vent coupler so that it lines up with the fitting installed in the K&N® intake tube, then connect the coupler to the fitting.



24. Connect the provided mass air sensor extension harness into the factory harness connection, and then connect the open end to the mass air sensor electrical connector.

**NOTE: Be sure to lock the mass air sensor connections with the red tabs.**



25. Reconnect the vehicle's negative battery cable. Double check to make sure everything is tight and properly positioned before starting the vehicle.

26. It will be necessary for all K&N® high flow intake systems to be checked periodically for realignment, clearance and tightening of all connections. Failure to follow the above instructions or proper maintenance may void warranty.

#### ROAD TESTING:

1. Start the engine with the transmission in neutral or park, and the parking brake engaged. Listen for air leaks or odd noises. For air leaks secure hoses and connections. For odd noises, find cause and repair before proceeding. This kit will function identically to the factory system except for being louder and much more responsive.

2. Test drive the vehicle. Listen for odd noises or rattles and fix as necessary.

3. If road test is fine, you can now enjoy the added power and performance from your kit.

4. K&N Engineering, Inc., requires cleaning the intake system's air filter element every 100,000 miles. When used in dusty or off-road environments, our filters will require cleaning more often. We recommend that you visually inspect your filter once every 25,000 miles to determine if the screen is still visible. When the screen is no longer visible some place on the filter element, it is time to clean it. To clean and re-oil, purchase our filter Recharger® service kit, part number 99-5050 or 99-5000 and follow the easy instructions.

**NOT LEGAL FOR SALE OR USE ON ANY POLLUTION CONTROLLED MOTOR VEHICLE IN CALIFORNIA OR STATES ADOPTING CALIFORNIA EMISSION PROCEDURES.**

See [knfilters.com](http://knfilters.com) for CARB status on each part for a specific vehicle