



AIRCHARGER®

HIGH-FLOW INTAKE KITS

NOT LEGAL FOR SALE OR USE ON ANY POLLUTION CONTROLLED MOTOR VEHICLE IN CALIFORNIA OR STATES ADOPTING CALIFORNIA EMISSION PROCEDURES.

See knfilters.com for CARB status on each part for a specific vehicle

INSTALLATION INSTRUCTIONS

63-7001
PORSCHE
2007 GT3
H6-3.6L

TOOLS NEEDED:

- 1/2" socket
- 4mm allen wrench
- 10mm wrench
- extension
- flat blade screwdriver
- ratchet
- t25 torx wrench

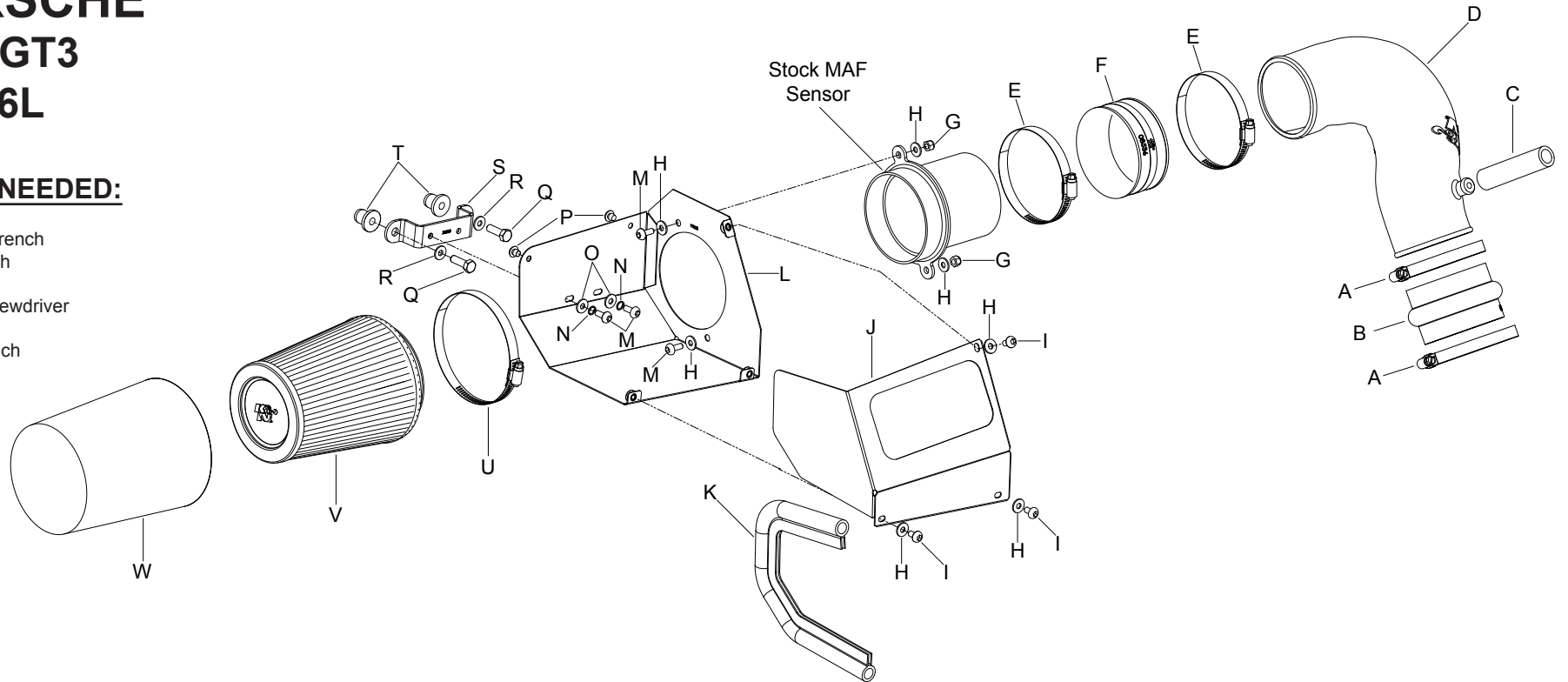

PARTS LIST:

Description	Qty.	Part #	Description	Qty.	Part #	Description	Qty.	Part #
A Hose Clamp #56	2	08620	I Bolt; M6 X 1.00" 12MM Buttonhead, SS	3	07794	Q Bolt; 5/16"- 18 x 1",ss	2	07777
B Hose; 3-1/2" ID X 2-1/2" L Hump	1	08699	J Heat shield Top	1	07363	R Washer; 5/16"ID X 5/8"OD, Flat	2	08276
C Hose; 5/8" ID X4"L, Black Silicone	1	08244	K Edge trim (17")	1	102469	S Bracket; "C", STL, FB/PC	1	26660
D Intake tube	1	087222	L Heat shield	1	07364	T Insert; 5/16-18 X .600 OD X .730L	2	088002
E Hose Clamp #60 Stainless	2	08628	M Bolt; M6 X 1.00 X 16MM , Buttonhead	4	07730	U Hose Clamp #72	1	08671
F Hose; 3-3/4" ID X 1-3/4" L Reinforced	1	08536	N Washer; 1/4" Lock, ZN	2	08198	V Air Filter	1	RP-5167
G Nut; 6MM Nylock, Hexhead, SS	2	07512	O Washer; 1/4"ID X 5/8"OD - SAE	2	08275	W Drycharger Wrap, Black, Custom	1	RF-1037DK
H Washer; 6MM Flat, SS	7	08269	P Plug, Rubber for RX Tops	2	08162			

NOTE: FAILURE TO FOLLOW INSTALLATION INSTRUCTIONS AND NOT USING THE PROVIDED HARDWARE MAY DAMAGE THE INTAKE TUBE, THROTTLE BODY AND ENGINE.

TO START:

1. Turn off the ignition and disconnect the negative battery cable.
NOTE: Disconnecting the negative battery cable erases pre-programmed electronic memories. Write down all memory settings before disconnecting the negative battery cable. Some radios will require an anti-theft code to be entered after the battery is reconnected. The anti-theft code is typically supplied with your owner's manual. In the event your vehicles' anti-theft code cannot be recovered, contact an authorized dealership to obtain your vehicles anti-theft code.



2. Depress the locking tab, then disconnect the mass air sensor electrical connection.

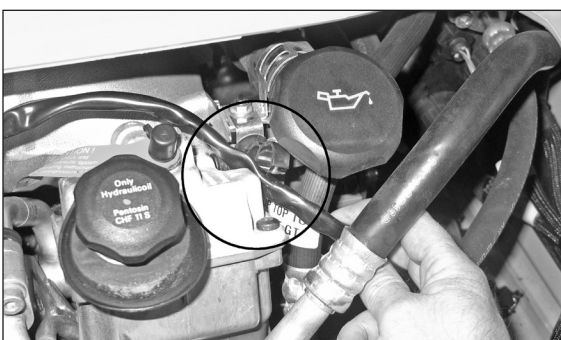

3. Release the mass air sensor clip (near the oil filler cap) as shown.



4. Remove the 10mm nut securing the harness clip, then remove the harness clip as shown. Re-install the 10mm nut and tighten. Set the harness clip aside for use in a later step.



5. Remove the crank case vent line from the factory intake tube as shown.

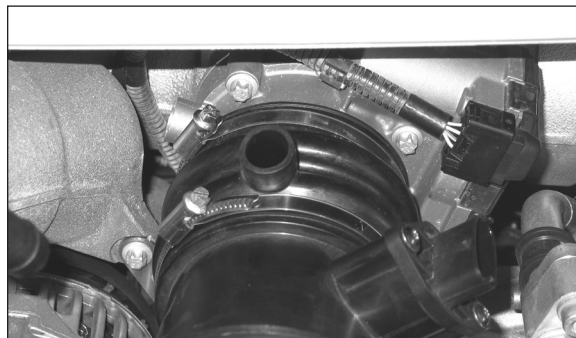

6. Loosen the hose clamp securing the factory intake tube to the throttle body as shown. Pull the factory intake tube from the throttle body.

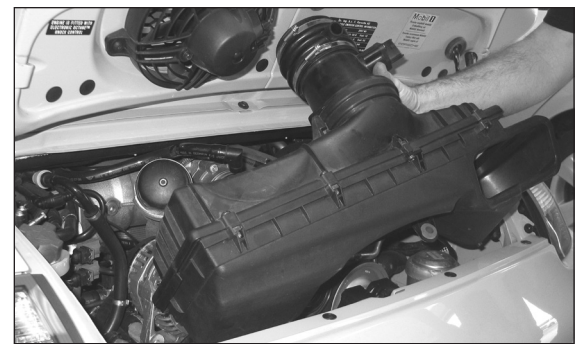

7. Pull up firmly, removing the factory air box and intake tube as shown.
NOTE: K&N Engineering, Inc., recommends that customers do not discard factory air intake.

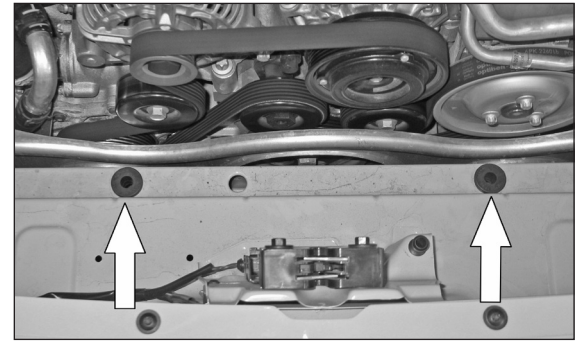

8. Remove the two air box mounting grommets as shown.

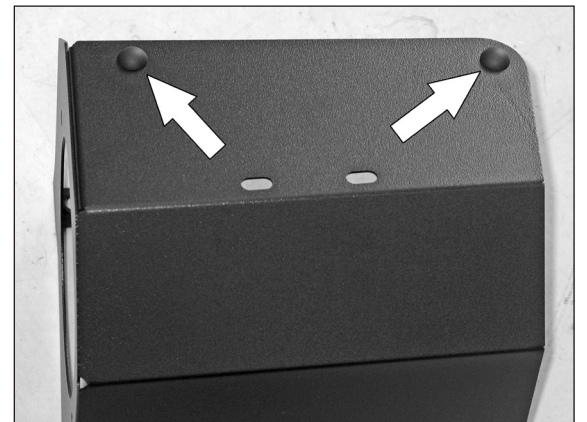

9. Install the two provided rubber bumpers onto the heat shield as shown.

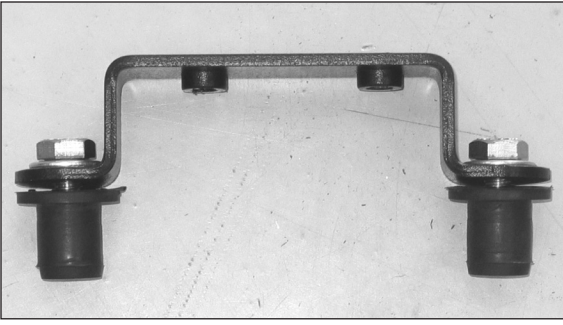

16. Assemble heat shield bracket (#26660) and threaded inserts with the provided hardware as shown.

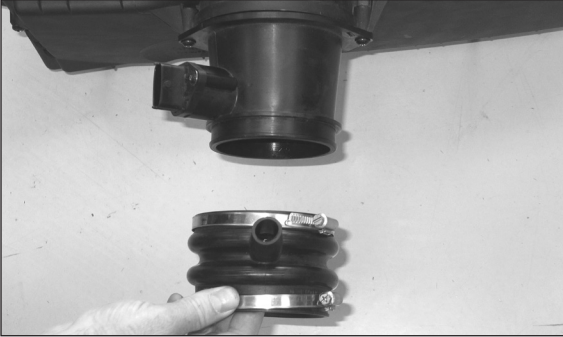

10. Loosen the hose clamp that secures the factory intake tube to the mass air sensor housing, then remove as shown.



11. Remove the two torx screws that secure the mass air sensor to the factory air box. Remove the mass air sensor housing as shown.

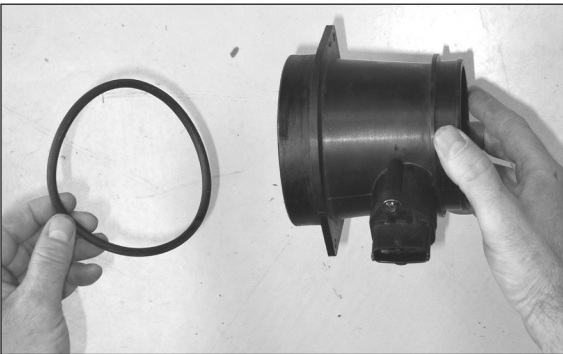

12. Remove the "O" ring seal from the mass air sensor housing as shown.

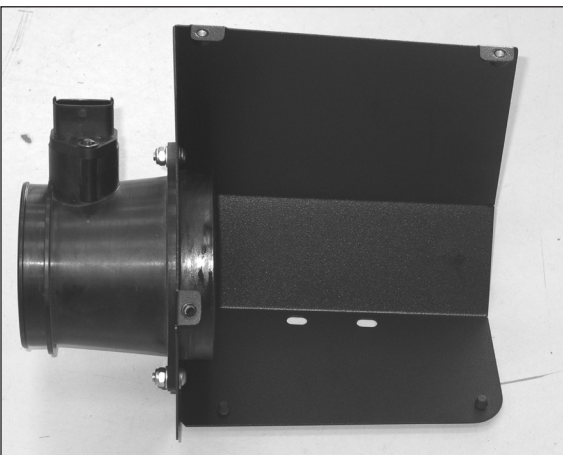

13. Install the mass air sensor housing into the heat shield and secure with the provided hardware as shown.

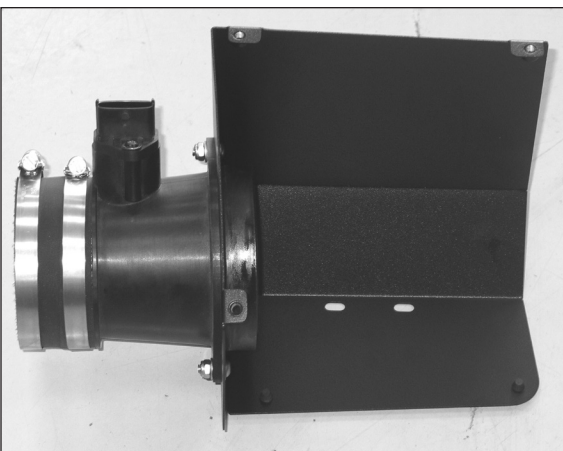

14. Install silicone hose (#08536) onto the mass air sensor housing and secure with the provided hardware as shown.



15. Install silicone hose (#08699) onto the throttle body and secure with the provided hose clamp as shown.

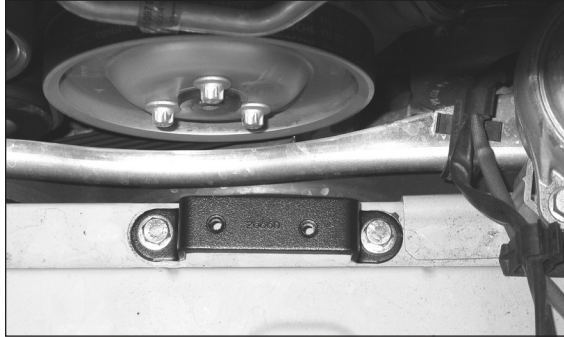

17. Install the heat shield bracket assembly into the grommet mounting holes as shown.

NOTE: The bracket holes are offset; be sure to position the bracket properly.

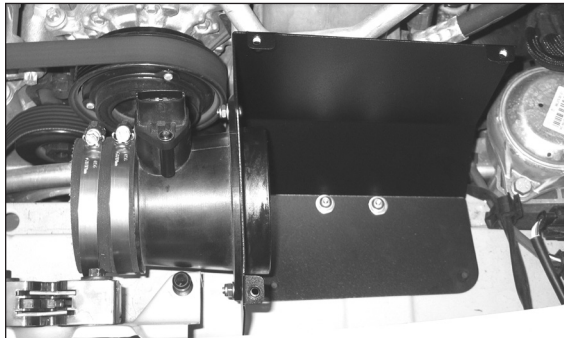

18. Install the heat shield assembly onto the heat shield bracket with the provided hardware as shown.

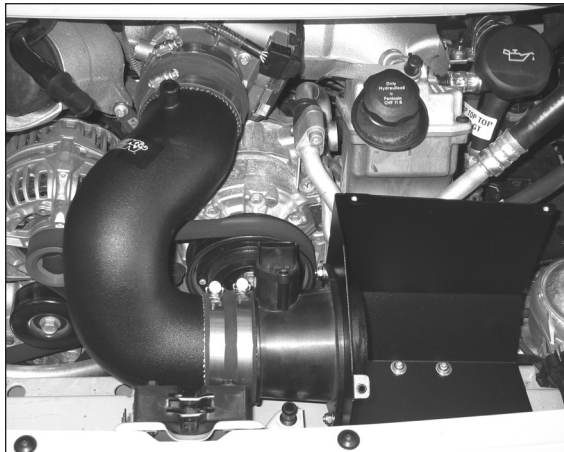

19. Install the K&N® intake tube onto the throttle body and mass air sensor housing. Secure with the provided hose clamps as shown.



20. Install the provided silicone hose onto the K&N® intake tube as shown.

NOTE: Some trimming of the hose will be necessary.



21. Re-connect the crank case vent line to the silicone hose installed in the previous step as shown.

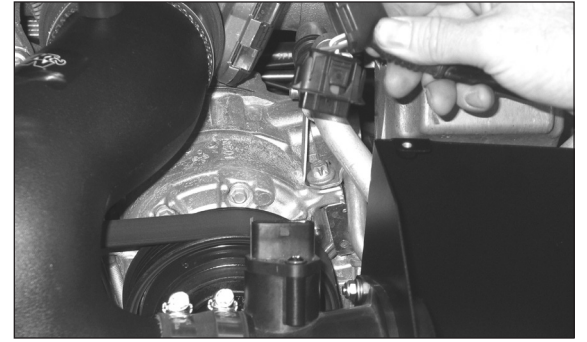

22. Pull the rubber wiring harness boot back from the mass air sensor electrical connector as shown. Rotate the connector 180 degrees and re-install the boot.

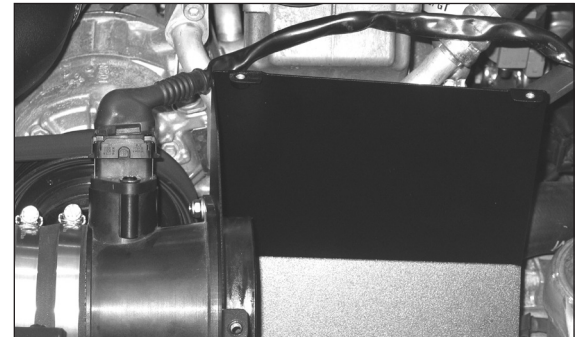

23. Route the mass air sensor harness and reconnect the mass air sensor electrical connector as shown.



24. Install the provided K&N® Drycharger® onto the K&N® air filter as shown.

NOTE: Please be aware the Drycharger® is water repellent, not water proof. Depending on conditions and usage the water repellent treatment is good for 1 to 2 years. See the parts list to reorder a new Drycharger® if necessary.



25. Install the K&N® air filter onto the K&N® intake tube and secure with the provided hose clamp as shown.



26. Install the provided edge trim onto the heat shield top cover as shown.
NOTE: Some trimming of the edge trim will be necessary.



27. Install the heat shield top cover and mass air sensor harness clip (removed in step # 4) onto the heat shield with the provided hardware as shown.

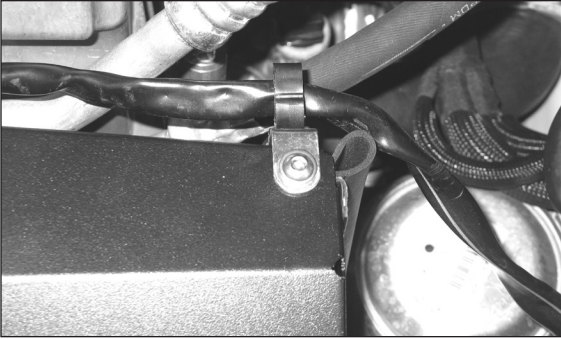

28. Re-attach the mass air sensor harness into the mass air sensor harness clip (mounted on heat shield) as shown.



29. Reconnect the vehicle's negative battery cable. Double check to make sure everything is tight and properly positioned before starting the vehicle.

Warning: Please follow these installation instructions carefully. The K&N® Drycharger® included with the kit must be installed on the K&N® air filter when used with a K&N® high flow intake system. The K&N® high flow intake system is a performance product that can be used safely during mild weather conditions. During harsh and inclement weather conditions, you must return your vehicle to stock OEM air box and intake tract configuration. Failure to follow these instructions will void your warranty.

30. It will be necessary for all K&N® high flow intake systems to be checked periodically for realignment, clearance and tightening of all connections. Failure to follow the above instructions or proper maintenance may void warranty.

ROAD TESTING:

1. Start the engine with the transmission in neutral or park, and the parking brake engaged. Listen for air leaks or odd noises. For air leaks secure hoses and connections. For odd noises, find cause and repair before proceeding. This kit will function identically to the factory system except for being louder and much more responsive.

2. Test drive the vehicle. Listen for odd noises or rattles and fix as necessary.

3. If road test is fine, you can now enjoy the added power and performance from your kit.

4. K&N Engineering, Inc., suggests checking the air filter element periodically for excessive dirt build-up. When the element becomes covered in dirt (or once a year), service it according to the instructions on the Recharger® service kit, part number 99-5050 or 99-5000.

NOT LEGAL FOR SALE OR USE ON ANY POLLUTION CONTROLLED MOTOR VEHICLE IN CALIFORNIA OR STATES ADOPTING CALIFORNIA EMISSION PROCEDURES.

See knfilters.com for CARB status on each part for a specific vehicle