



TYPHOON INTAKE SYSTEMS

INTAKE SYSTEMS FOR VEHICLES LISTED ARE 50 STATE LEGAL. SEE KNFILTERS.COM FOR CARB STATUS ON EACH PART FOR A SPECIFIC VEHICLE.

INSTALLATION INSTRUCTIONS

69-2548TS
DODGE
2013-14 Dart
L4-1.4L turbo

TOOLS NEEDED:

- Flat Blade Screw Driver
- Ratchet
- Extension
- 10mm Socket
- T30 Torx
- 10mm Wrench
- Pliers

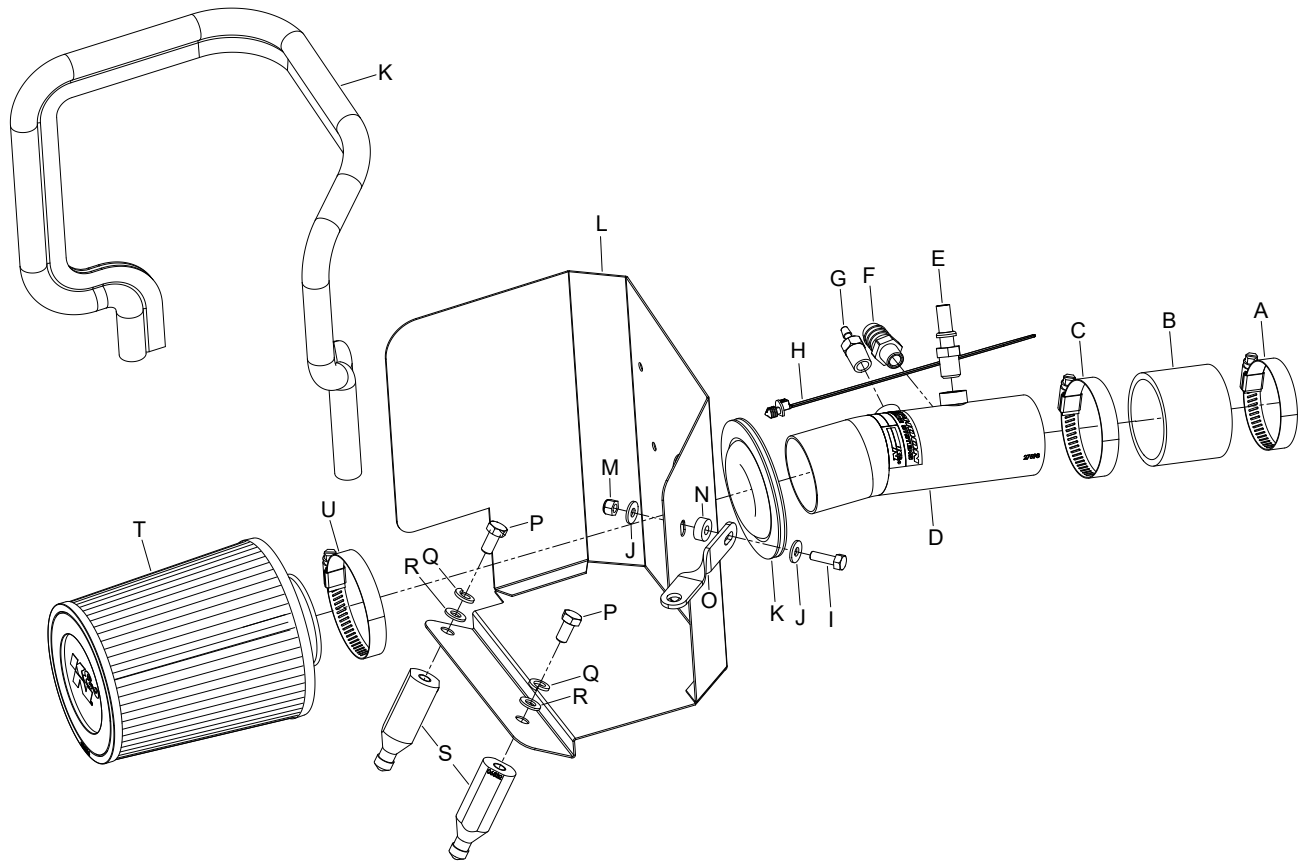

PARTS LIST:

Description	Qty.	Part #	Description	Qty.	Part #	Description	Qty.	Part #
A HOSE CLAMP; #32	1	08507	H ZIP TIE; 8" TREE PUSH-MNT	1	1-127	O BRACKET; SHORT TWIST	1	070702
B HOSE; SILICONE 2.25 X 2"	1	5-222N	I BOLT; M6 X 1 X 20MM	1	07795	P BOLT; 8MM-1.25 X 16MM	2	07844
C HOSE CLAMP; #36	1	08530	J WASHER; 6MM FLAT	2	08269	Q WASHER; M8 SPLIT LOCK	2	1-3036
D INTAKE TUBE; SILVER	1	27598TS	K EDGE TRIM; 46"L	1	102487	R WASHER; 8M FLAT	2	08272
E VENT; 1/4"NPT	1	08938	L HEAT SHIELD	1	073132	S STANDOFF; 6.0 AIRBOX	2	06532
F FITTING; VENT 1/4"NPT	1	82638	M NUT; 6MM NYLOCK	1	07512	T AIR FILTER	1	RU-3560
G FITTING; 1/4"NPT, 3/16 BARB	1	080021	N SPACER; .625"OD X .250"ID	1	06555	U HOSE CLAMP; #40	1	08554

NOTE: FAILURE TO FOLLOW INSTALLATION INSTRUCTIONS AND NOT USING THE PROVIDED HARDWARE MAY DAMAGE THE INTAKE TUBE, THROTTLE BODY AND ENGINE.

TO START:

1. Turn off the ignition and disconnect the negative battery cable.
NOTE: Disconnecting the negative battery cable erases pre-programmed electronic memories. Write down all memory settings before disconnecting the negative battery cable. Some radios will require an anti-theft code to be entered after the battery is reconnected. The anti-theft code is typically supplied with your owner's manual. In the event your vehicles' anti-theft code cannot be recovered, contact an authorized dealership to obtain your vehicles anti-theft code.



2. Remove the two bolts securing the engine cover and then remove the cover from the vehicle.



3. Disconnect the crankcase vent hose, EVAP hose and BOV valve hose from the stock intake tube as shown.



4. Loosen the hose clamps securing the intake tube to the turbo inlet and air box. Then remove the stock intake tube.



5. Remove the bolt securing the factory air box and then remove the factory air box from the vehicle.
NOTE: This bolt will be reused in a later step.

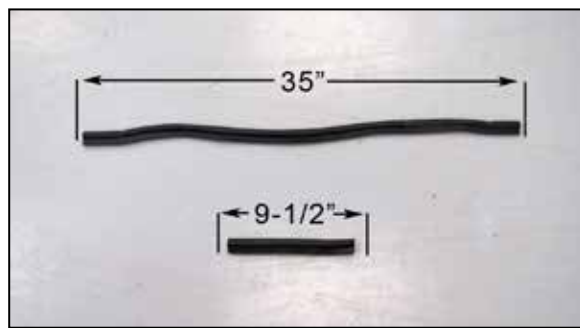

6. Cut the provided edge trim into two sections, the long section should be 35" long, the short section will be 9-1/2" long.

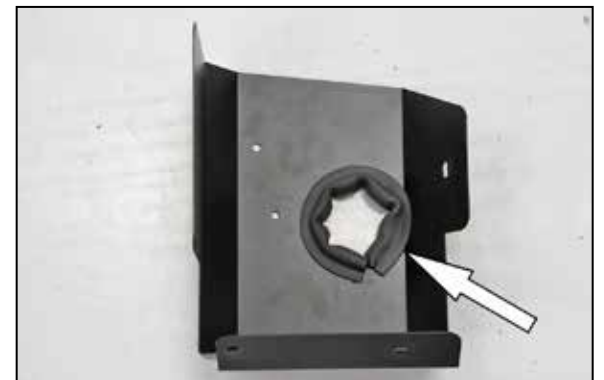

7. Install the short section of edge trim into the hole of the heat shield as shown.

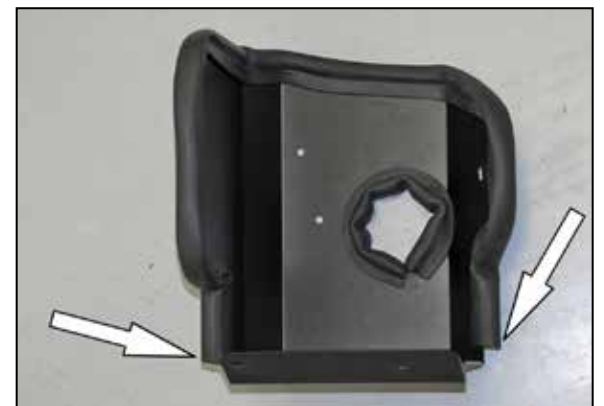

8. Install the long section of edge trim around the outside of the heat shield as shown.

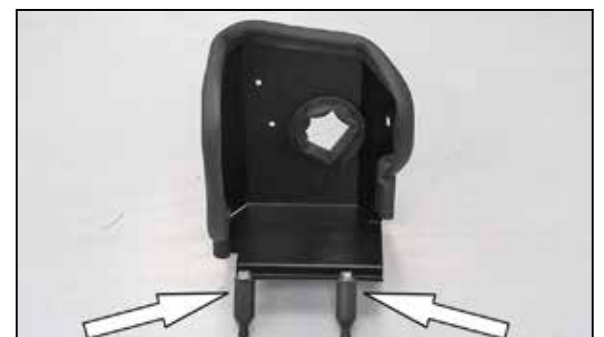

9. Install the two provided heat shield stand-offs onto the heat shield using the provided hardware.

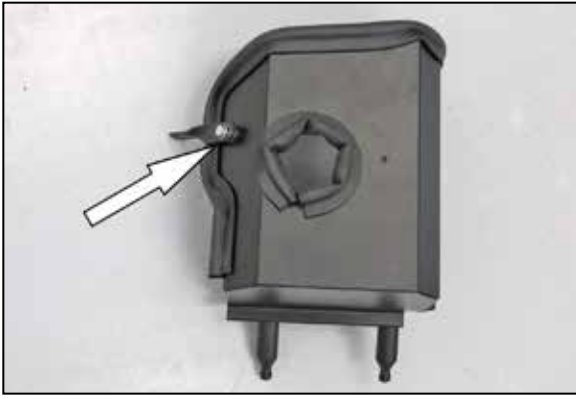

10. Install the provided heat shield mounting bracket (070702) onto the heat shield using the provided spacer between the heat shield and bracket.



11. Install the heat shield into position so the stand-offs set into the air box mounting grommets.
NOTE: Do not secure the mounting bracket to the core support at this time.

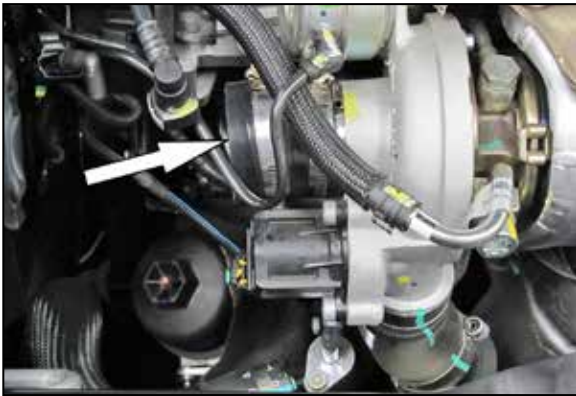

12. Install the provided silicone hose (5-222N) onto the turbo inlet and secure with the provided hose clamp.



13. Install the provided quick disconnect fitting into the K&N intake tube as shown.
NOTE: K&N Engineering, Inc., recommends that customers do not discard factory air intake.



14. Install the 3/16" vent fitting and 5/8" vent fitting into the K&N intake tube as shown. **Note: NPT fitting has tapered threads and only designed to be installed until hand tight, then tighten one rotation or when the fitting becomes difficult to return.**



15. Tilt the heat shield towards the fender, install the K&N intake tube through the hole in the heat shield and then install into the silicone hose on the turbo. Rotate the tube so the vent fittings align with the factory hoses and then secure the tube with the provided hose clamp.



16. Secure the heat shield mounting bracket with the factory bolt removed in step #5 but do not completely tighten at this time.



17. Connect the crank case vent hose, EVAP vent hose and BOV hose the fittings installed into the K&N intake tube.



18. Remove the factory coolant hose retaining clip, then install the provided mounting head tie wrap into the lower hole in the heat shield and secure the coolant hose as shown.



19. Reinstall the engine cover and secure with the factory mounting bolts. Adjust and heat shield for best fit and then secure with the hardware and hose clamps provided.

Note: due to manufacturing tolerances, the engine cover may make contact with the heat shield. Some trimming of the lip of the engine cover maybe necessary.



20. Install the K&N air filter and secure with the provided hose clamp.



21. Reconnect the vehicle's negative battery cable. Double check to make sure everything is tight and properly positioned before starting the vehicle.

22. The C.A.R.B. exemption sticker, (attached), must be visible under the hood so that an emissions inspector can see it when the vehicle is required to be tested for emissions. California requires testing every two years, other states may vary.

23. It will be necessary for all K&N high flow intake systems to be checked periodically for realignment, clearance and tightening of all connections. Failure to follow the above instructions or proper maintenance may void warranty.

ROAD TESTING:

1. Start the engine with the transmission in neutral or park, and the parking brake engaged. Listen for air leaks or odd noises. For air leaks secure hoses and connections. For odd noises, find cause and repair before proceeding. This kit will function identically to the factory system except for being louder and much more responsive.

2. Test drive the vehicle. Listen for odd noises or rattles and fix as necessary.

3. If road test is fine, you can now enjoy the added power and performance from your kit.

4. K&N Engineering, Inc., requires cleaning the intake system's air filter element every 100,000 miles. When used in dusty or off-road environments, our filters will require cleaning more often. We recommend that you visually inspect your filter once every 25,000 miles to determine if the screen is still visible. When the screen is no longer visible some place on the filter element, it is time to clean it. To clean and re-oil, purchase our filter Recharger service kit, part number 99-5050 or 99-5000 and follow the easy instructions.

INTAKE SYSTEMS FOR VEHICLES LISTED ARE 50 STATE LEGAL. SEE KNFILTERS.COM FOR CARB STATUS ON EACH PART FOR A SPECIFIC VEHICLE.