



TYPHOON INTAKE SYSTEMS

INTAKE SYSTEMS FOR VEHICLES LISTED ARE 50 STATE LEGAL. SEE KNFILTERS.COM FOR CARB STATUS ON EACH PART FOR A SPECIFIC VEHICLE.

69-8606TP
69-8606TB
SCION / TOYOTA
2003-05 xA
L4-1.5L
1999-00 Yaris
L4-1.3L

INSTALLATION INSTRUCTIONS

TOOLS NEEDED:

- Flat Blade Screwdriver
- Phillips Screwdriver
- 3mm Allen Wrench
- Ratchet
- Extension
- 10mm Socket
- Cutting tool

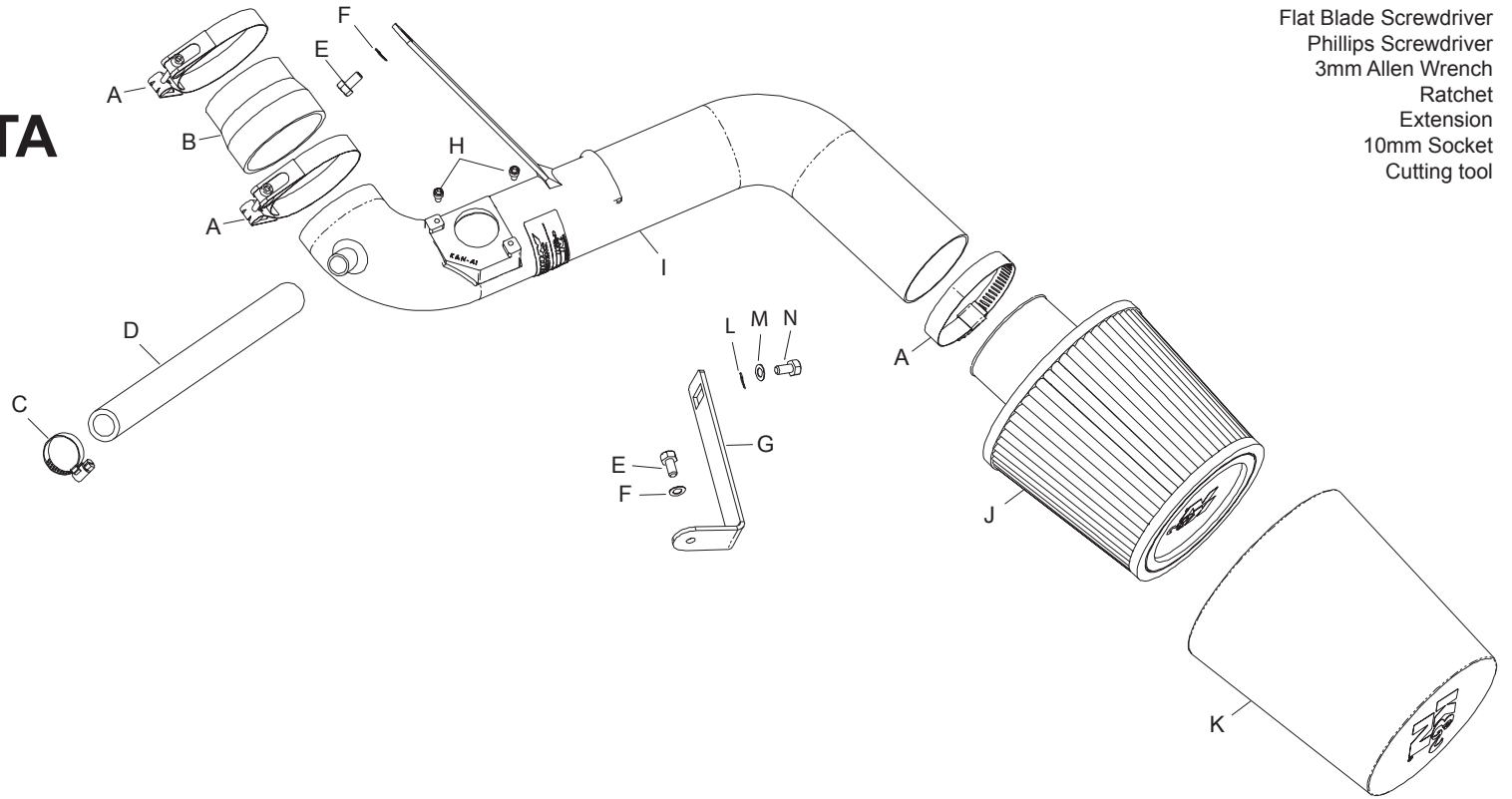

PARTS LIST:

Description	Qty.	Part #	Description	Qty.	Part #	Description	Qty.	Part #
A Hose Clamp; #40	3	08554	F Washer; Wave, 6MM, SS	2	08277	K Drycharger®	1	RX-4990DK
B Hose; 2-1/4" To 2-1/2" X 2" L	1	08476	G Bracket; "L" FB/PC STL	1	26652	L Washer; 5MM Inter. Star Lock	1	07724
C Hose Clamp #10 Mini	1	08411	H Bolt; M4-0.4X8MM, C/H/A	2	07733	M Washer; 5MM Wave	1	08268
D Hose; 5/8" ID X 14" L	1	084083	I Intake Tube	1	27164	N Bolt; M5-0.8X12MM B/H, SS	1	07734
E Bolt; M6-1.00X12MM, Hex, SS	2	07727	J Air Filter	1	RU-4950			

WARNING: The K&N® Drycharger® included with this kit must be installed on the K&N® air filter when used with this K&N® cold air intake system. The K&N® cold air intake system a performance product that can be used safely during mild weather conditions. During harsh and inclement weather conditions, you must convert your cold air intake system to a short ram configuration, or return your vehicle to the stock OEM air box and intake tract configuration. Failure to follow these instructions can void your warranty.

NOTE: FAILURE TO FOLLOW INSTALLATION INSTRUCTIONS AND NOT USING THE PROVIDED HARDWARE MAY DAMAGE THE INTAKE TUBE, THROTTLE BODY AND ENGINE.

TO START:

1. Turn off the ignition and disconnect the negative battery cable.

NOTE: Disconnecting the negative battery cable erases pre-programmed electronic memories. Write down all memory settings before disconnecting the negative battery cable. Some radios will require an anti-theft code to be entered after the battery is reconnected. The anti-theft code is typically supplied with your owner's manual. In the event your vehicles' anti-theft code cannot be recovered, contact an authorized dealership to obtain your vehicles anti-theft code.



2. Remove the 4 bolt securing the engine cover, then remove as shown.



3. Disconnect the mass air sensor electrical connection as shown.



4. Using a flat blade screwdriver unclip the wire harness as shown.



5. Remove the tape that binds the mass air sensor wire harness to the vacuum switching valve wire harness as shown.



6. Use a flat blade screwdriver to unclip the vacuum switching valve from the side of the air cleaner assembly as shown.
NOTE: On 2006 and later vehicles the vacuum switching valve may be held on with a screw.



7. Disconnect the crank case vent hose from the stock intake tube as shown.

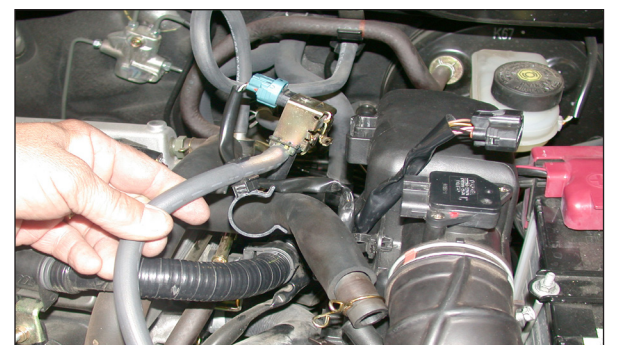

8. Unclip the vacuum hose from the crank case vent hose as shown.



9. Disconnect the crank case vent hose from the cam cover, then, remove the crank case vent hose as shown.



10. Loosen the hose clamps at the throttle body and at the air cleaner assembly, then, remove the stock intake tube as shown.



11. Release the clamps on the upper air cleaner assembly, then remove the upper air cleaner assembly as shown.

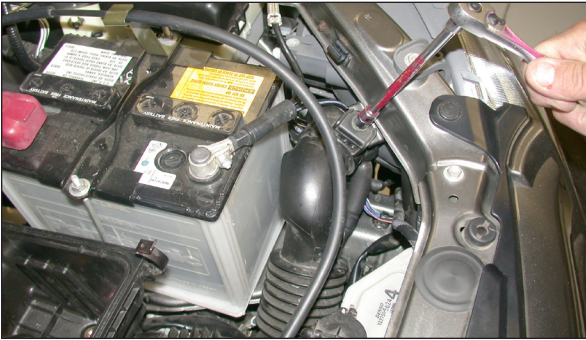

12. Remove the bolt that secures the air inlet duct as shown.

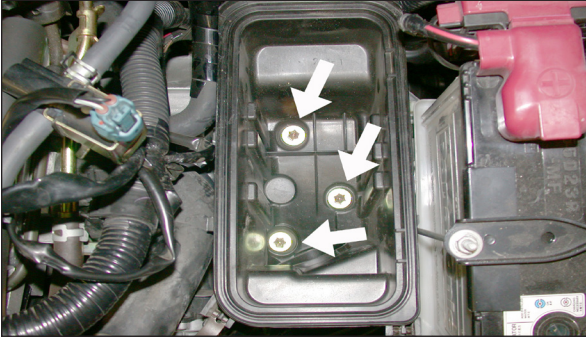

13. Remove the three screws that secure the lower air cleaner assembly as shown.



14. Pull upwards to remove the lower air cleaner assembly as shown.

NOTE: K&N Engineering, Inc., recommends that customers do not discard factory intake.

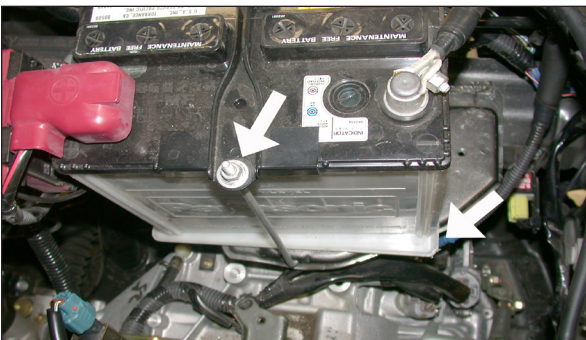

15. Loosen the battery hold down bracket and slide the battery as far towards the fender as possible.

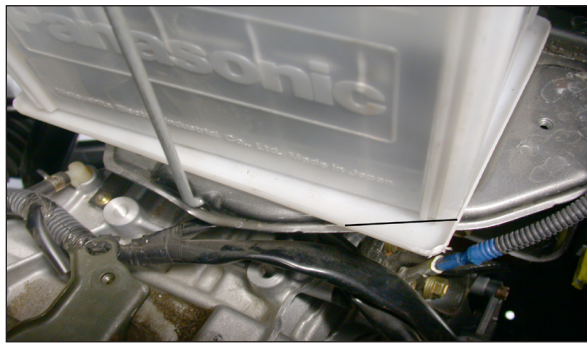

16. Using a cutting tool, trim the plastic battery tray to mirror the inner fender as shown.

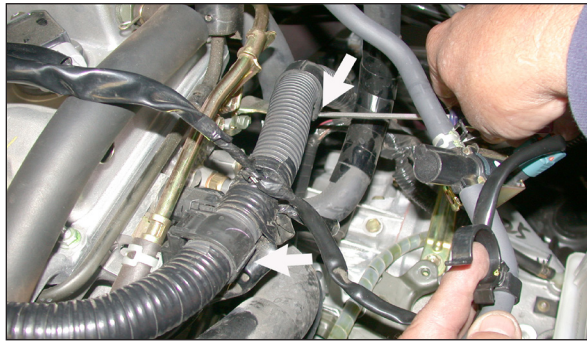

17. Unclip the two plastic wire harness clips to gain more slack for the mass air sensor electrical connection as shown.



18. Raise the vehicle up and support it with jack stands, then, remove the front driver side tire as shown.



19. Remove the plastic air dam that is secured by three bolts, then remove as shown.



20. Remove the two bolts that secure the inner fender valance, then, lower the valance downward as shown.

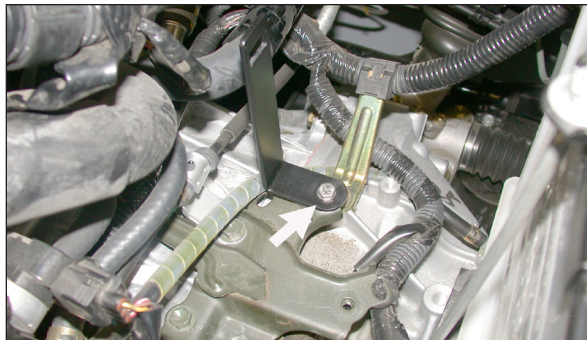

21. Install the provided "L" bracket onto the stock air cleaner mounting hole using the provided hardware as shown.

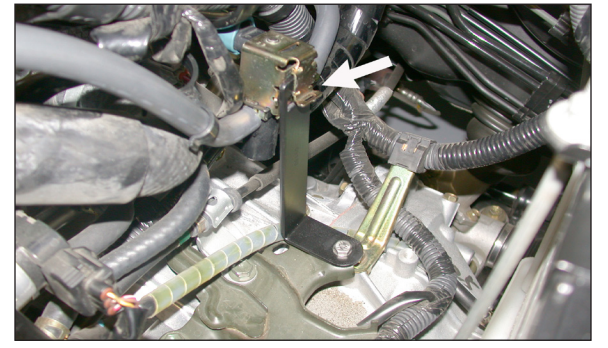

22. Slide the vacuum switching valve onto the "L" bracket as shown.

NOTE: On 2007 and later vehicles, use the provided screw, star washer, and flat washer to attach the vacuum switching valve to the bracket.

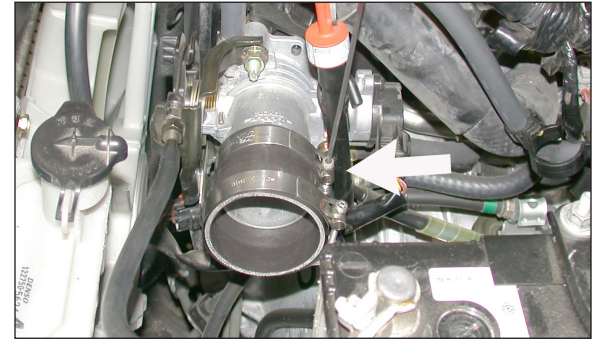

23. Install the silicone step hose and hose clamps onto the throttle body and tighten as shown.

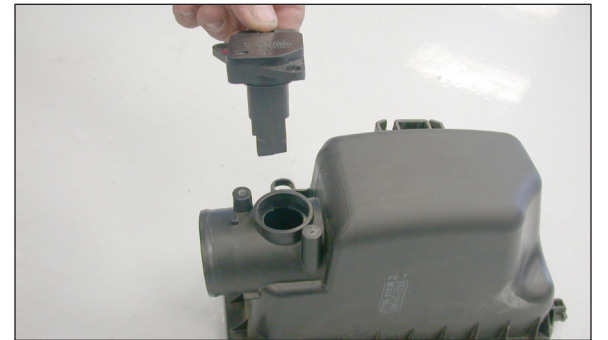

24. Remove the mass air sensor from the upper air cleaner assembly as shown.

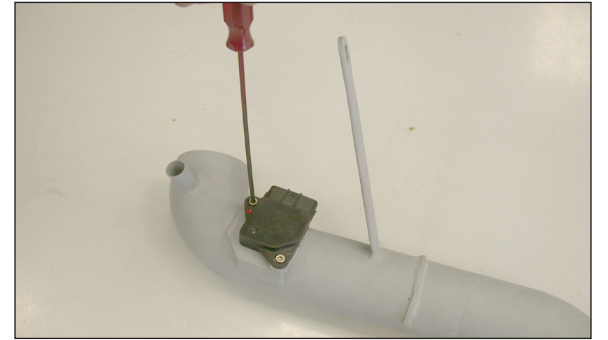

25. Install the stock mass air sensor into the K&N® cold air tube and secure with the provided hardware as shown.



26. Slide the K&N® cold air tube into the engine compartment as shown.

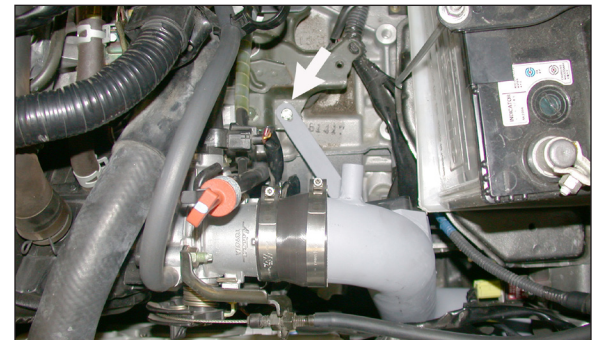

27. Slide the end of the tube into the silicone hose on the throttle body, then secure the bracket to the air cleaner mounting hole using the provided hardware as shown but do not tighten at this time.

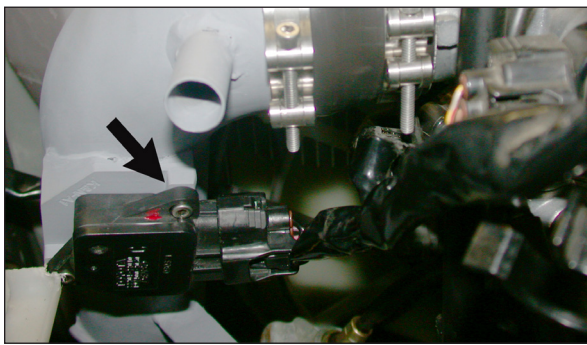

28. Reconnect the mass air sensor electrical connection using the provided hardware as shown.

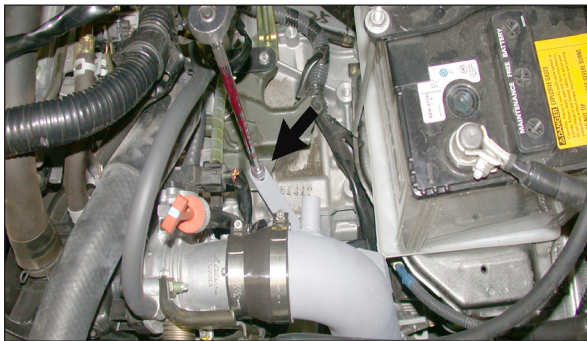

29. Adjust the tube for best fit then tighten the bracket and the hose clamp as shown.

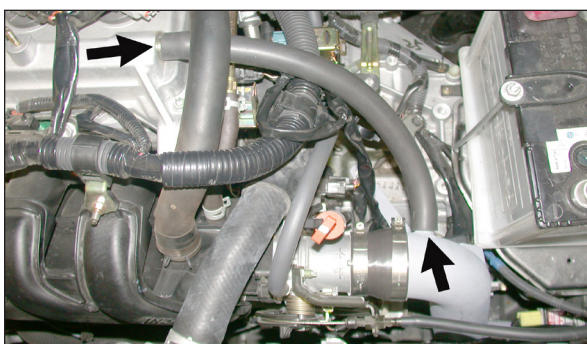

30. Install the provided silicone hose onto the vent on the K&N® intake tube, then, connect the other end to the vent on the cam cover along with the provided hose clamp.



31. Install the Drycharger® onto the K&N® air filter as shown.

NOTE: Please be aware the Drycharger® is water repellent, not water proof. Depending on conditions and usage the water repellent treatment is good for 1 to 2 years. See the parts list to reorder a new Drycharger® if necessary.



32. From underneath the vehicle pull the inner fender valance down, then, slide the air filter onto the cold air tube and secure with the provided hose clamp.

33. Reverse the removal process and secure the inner fender valance.

34. Re-install the front tire and torque to factory specs.



35. Install the engine cover back onto the vehicle.



36. Reconnect the vehicle's negative battery cable. Double check to make sure everything is tight and properly positioned before starting the vehicle.

WARNING: Please follow these installation instructions carefully. The K&N® high flow intake system is a performance product that can be used safely during mild weather conditions. During harsh and inclement weather conditions, you must return your vehicle to stock OEM air box and intake tract configuration. Failure to follow these instructions will void your warranty.

37. The C.A.R.B. exemption sticker, (attached), must be visible under the hood, so the emissions inspector can see it when the vehicle is required to be tested for emissions. California requires testing every two years, other states may vary.

38. It will be necessary for all K&N® high flow intake systems to be checked periodically for realignment, clearance and tightening of all connections. Failure to follow the above instructions or proper maintenance may void warranty.

ROAD TESTING:

1. Start the engine with the transmission in neutral or park, and the parking brake engaged. Listen for air leaks or odd noises. For air leaks secure hoses and connections. For odd noises, find cause and repair before proceeding. This kit will function identically to the factory system except for being louder and much more responsive.

2. Test drive the vehicle. Listen for odd noises or rattles and fix as necessary.

3. If road test is fine, you can now enjoy the added power and performance from your kit.

4. K&N Engineering, Inc., requires cleaning the intake system's air filter element every 100,000 miles. When used in dusty or off-road environments, our filters will require cleaning more often. We recommend that you visually inspect your filter once every 25,000 miles to determine if the screen is still visible. When the screen is no longer visible some place on the filter element, it is time to clean it. To clean and re-oil, purchase our filter Recharger® service kit, part number 99-5050 or 99-5000 and follow the easy instructions.

INTAKE SYSTEMS FOR VEHICLES LISTED ARE 50 STATE LEGAL. SEE KNFILTERS.COM FOR CARB STATUS ON EACH PART FOR A SPECIFIC VEHICLE.