

Installation Instructions



Lund EZ Bracket™

For proper installation and best possible fit, please read all instructions BEFORE you begin.

For technical assistance or to obtain missing parts, please call Customer Relations at 1-800-328-5863.

Important Safety Information

! WARNING

- To be used with Lund branded products only.
- Do not stand on Lund running board or bracket while vehicle is in motion.
- Do not exceed 350lbs. weight on the Lund EZ bracket system.
- Do not use the Lund EZ bracket system as a jacking point for vehicle.
- Do not use Lund EZ bracket system or running boards to fasten cargo.
- Periodically check all components for tightness.

! CAUTION

- Be sure to wear safety glasses while installing Lund EZ bracket system.
- When using power tools read and understand all operating manuals.

Contents

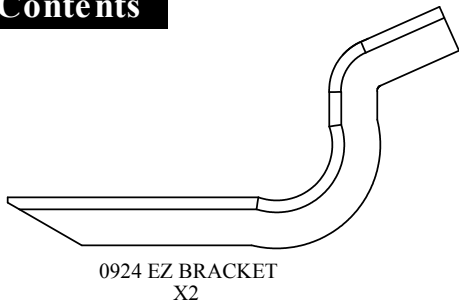

0924 EZ BRACKET
X2

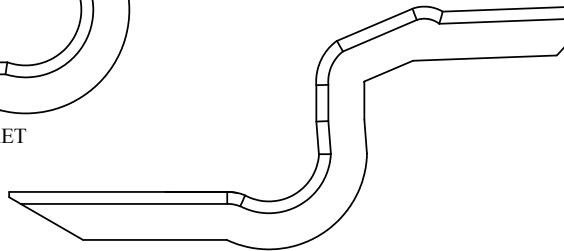

0923 EZ BRACKET
X2



WASHER HEAD
BOLT
X12



WASHER
X12

Tools Required

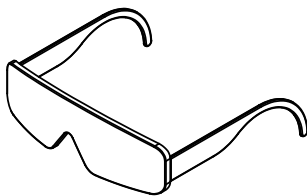

SAFETY GLASSES



13MM SOCKET

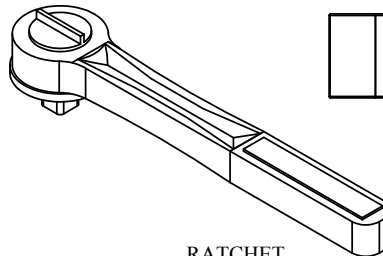

RATCHET

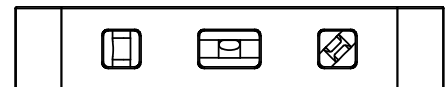

LEVEL

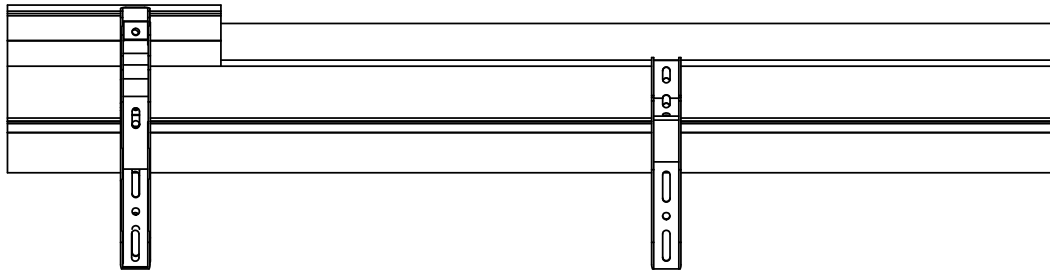

Passenger side, bottom view

1

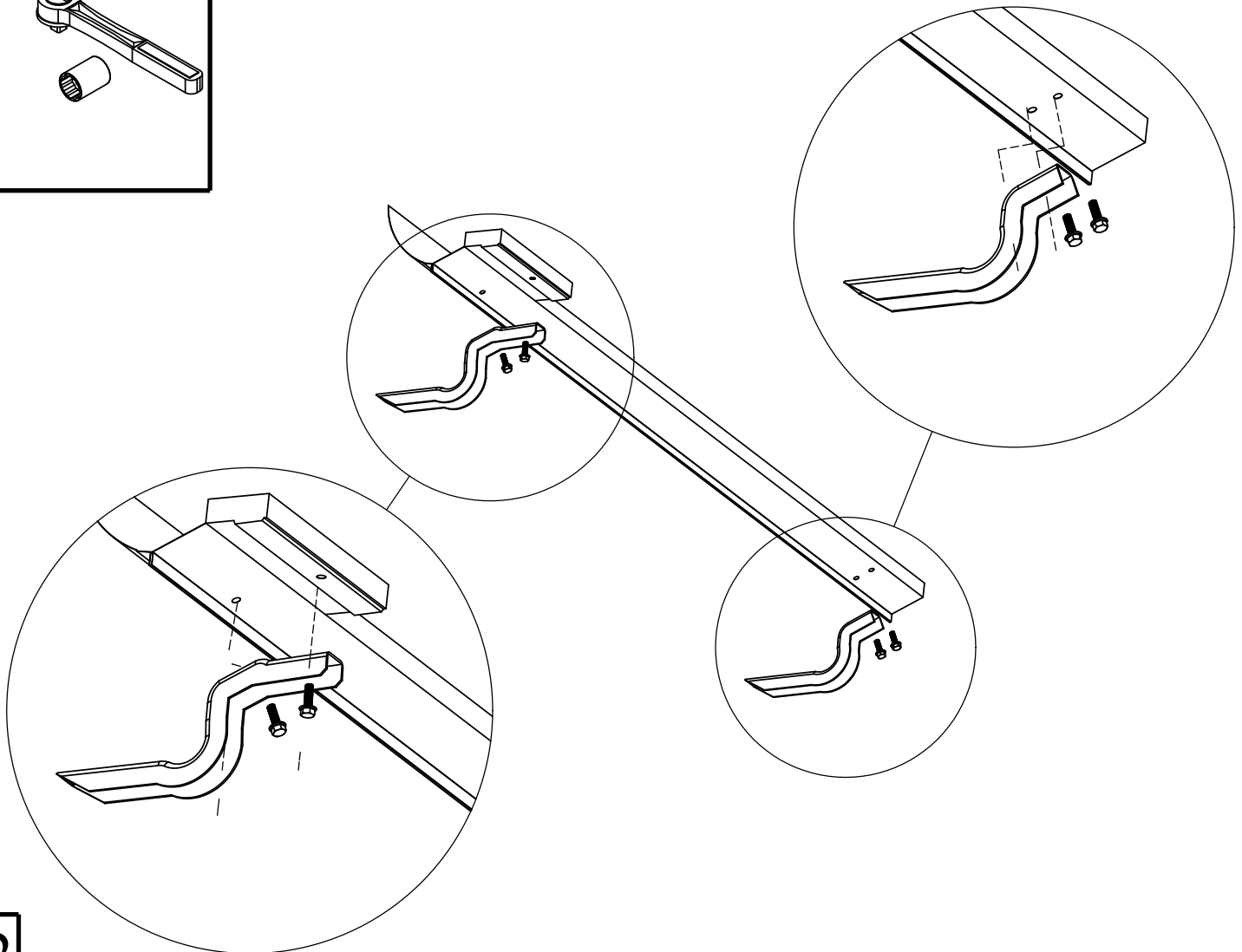
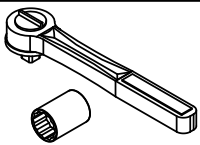

2

Use flat washers if necessary to adjust the bracket

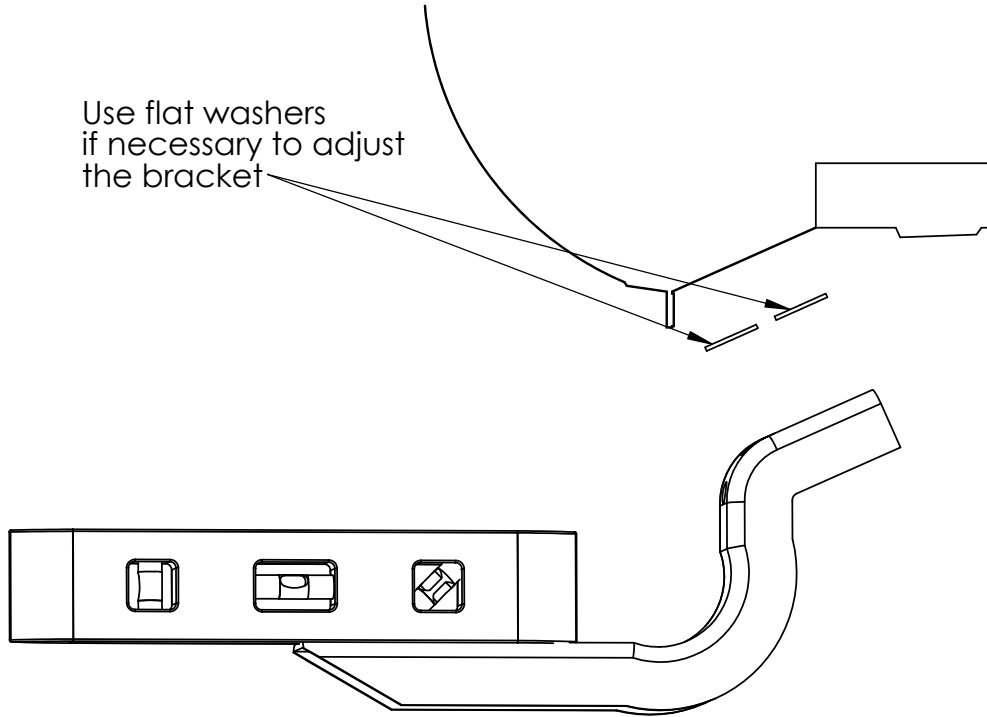

3

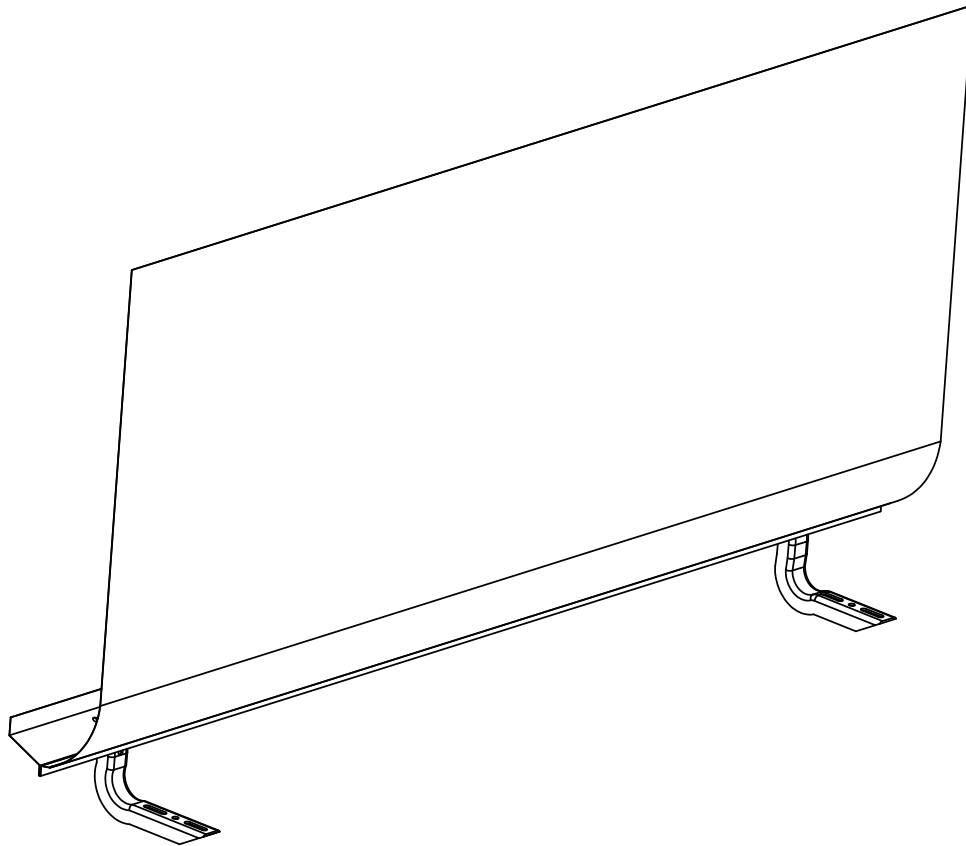

4

Congratulations

You have purchased one of the many quality Lund® branded products offered by Lund International, Inc. We take the utmost pride in our products and want you to enjoy years of satisfaction from your investment. We have made every effort to ensure that your product is top quality in terms of fit, durability, finish and ease of installation.



Lund International, Lund Accessories Division
775 Tipton Industrial Drive, Building 2, Suite F, Lawrenceville, GA 30045
800-328-5863 • Fax 800-782-5448 • Visit us at lundinternational.com

© 2005 Lund International, Inc. All rights reserved.
Lund® and the Lund® logo are trademarks of Lund International, Inc.



Instrucciones del Installation



Lund EZ Bracket™

Recomendamos leer las instrucciones antes de comenzar para lograr una instalación correcta y precisa.

Si necesita asistencia técnica o desea solicitar piezas faltantes, comuníquese con el departamento de atención al cliente al 1-800-328-5863.

Información importante de seguridad



ADVERTENCIA

- Utilizar sólo con productos de la marca Lund.
- No se pare sobre el estribo Lund ni sobre el soporte cuando el vehículo se encuentre en movimiento.
- No exceda el límite de peso de 159 Kg. sobre el sistema de soportes EZ de Lund.
- No utilice el gato en el área de los soportes EZ de Lund para levantar el vehículo.
- No utilice el sistema de soportes EZ de Lund ni los estribos para sujetar cargas.
- Revise con regularidad que los componentes se encuentren bien ajustados.



PRECAUCION

- Utilice lentes de seguridad cuando instale el sistema de soportes EZ de Lund.
- Antes de utilizar herramientas eléctricas lea las instrucciones de uso.

Contenido

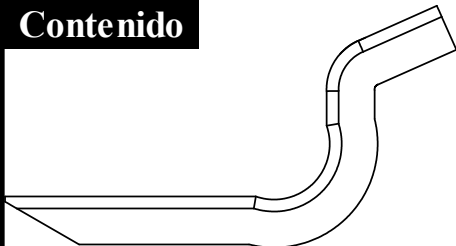

SOPORTE DE 0924 EZ
X2

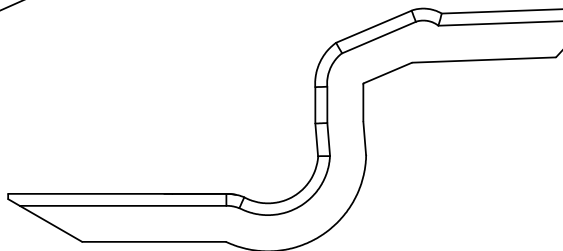

SOPORTE DE 0923 EZ
X2



PERNO PRINCIPAL
DE LA ARANDELA
X 12



ARANDELA
X 12

Herramientas Necesarias

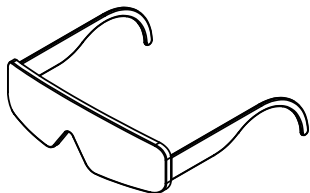

GAFAS DE SEGURIDAD



ZÓCALO de 13M M"

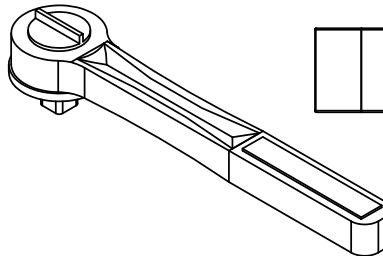

TRINQUETE

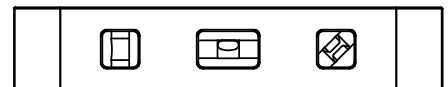

NIVEL

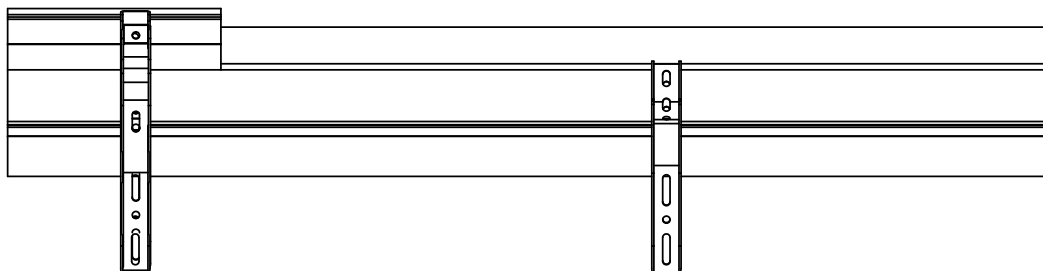

1

Lado del pasajero, visión inferior

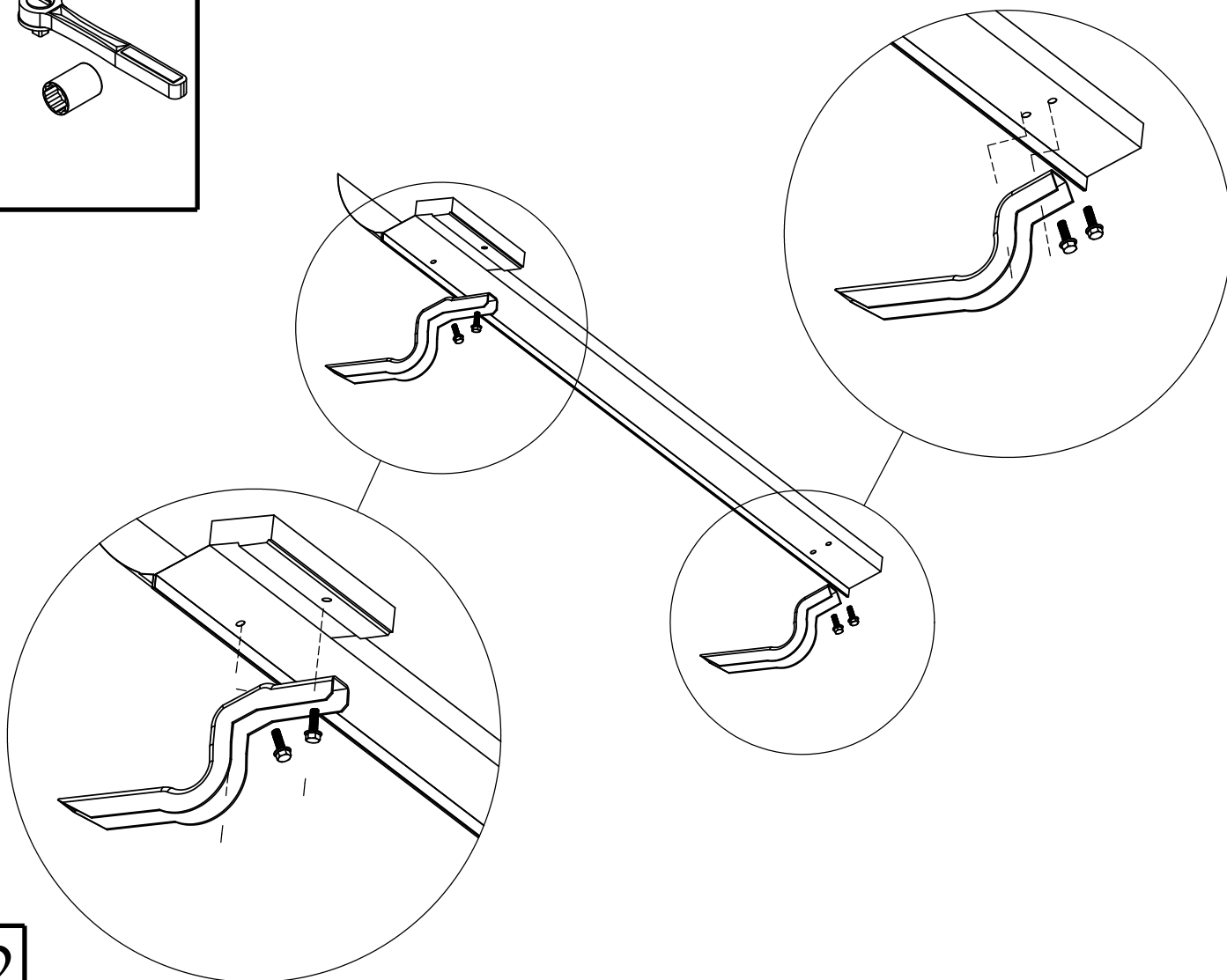
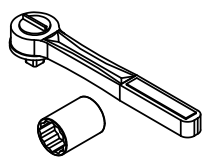

2

Utilice las arandelas planas en caso de necesidad para ajustar el soporte

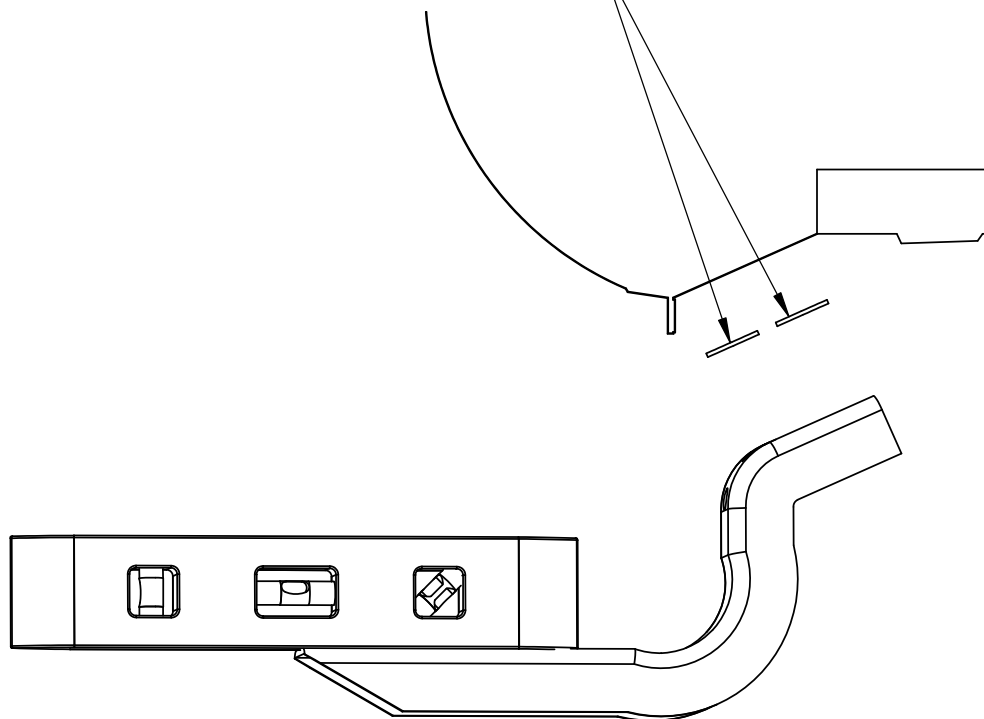

3

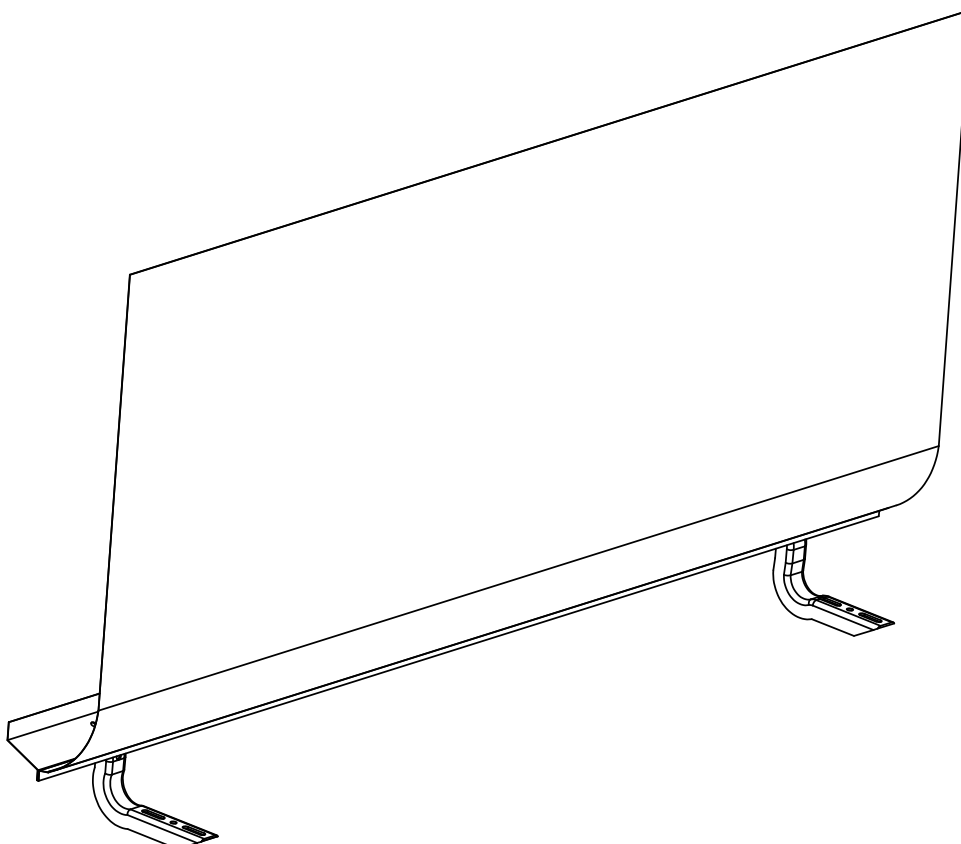

4

Felicitaciones

Ha adquirido uno de los productos de la marca Lund® de la extensa línea de gran calidad que ofrece Lund International, Inc. Nos enorgullece enormemente ofrecerle nuestros productos y deseamos que disfrute de su inversión durante muchos años. Hemos realizado todos los esfuerzos pertinentes para garantizar que el ajuste, durabilidad, acabado y facilidad de instalación del producto sean de la más alta calidad.



Lund International, Lund Accessories Division
775 Tipton Industrial Drive, Building 2, Suite F, Lawrenceville, GA 30045
800-328-5863 • Fax 800-782-5448 • Visítenos en lundinternational.com

© 2005 Lund International, Inc. Todos los derechos reservados.
Lund® y Lund® la insignia es marcas registradas de Lund International, Inc.



Instructions d'installation



Lund EZ Bracket™

Pour assurer la meilleure installation possible, veuillez lire les instructions AVANT de commencer.

Pour toute assistance technique ou en cas de pièce manquante, communiquez avec le service des relations avec les clients au 1 800 328-5863

Información Importante De Seguridad

- ⚠ ADVERTISSEMENT
- Être employé avec Lund a stigmatisé des produits seulement.
 - Ne vous tenez pas sur le conseil courant de Lund ou n'encadrez pas tandis que le véhicule est dans le mouvement.
 - N'excédez pas 350lbs. poids sur les parenthèses de Lund EZ.
 - N'utilisez pas les parenthèses de Lund EZ comme appui de levage pour le véhicule.
 - N'employez pas les parenthèses de Lund EZ ou les conseils courants pour attacher la cargaison.
 - Examinez périodiquement tous les composants pour assurer l'étanchéité.
- ⚠ ATTENTION
- Soyez sûr de porter des verres de sûreté tout en installant des parenthèses de Lund EZ.
 - À l'aide des machines-outils lisez et comprenez tous les operating manual.

Contenu

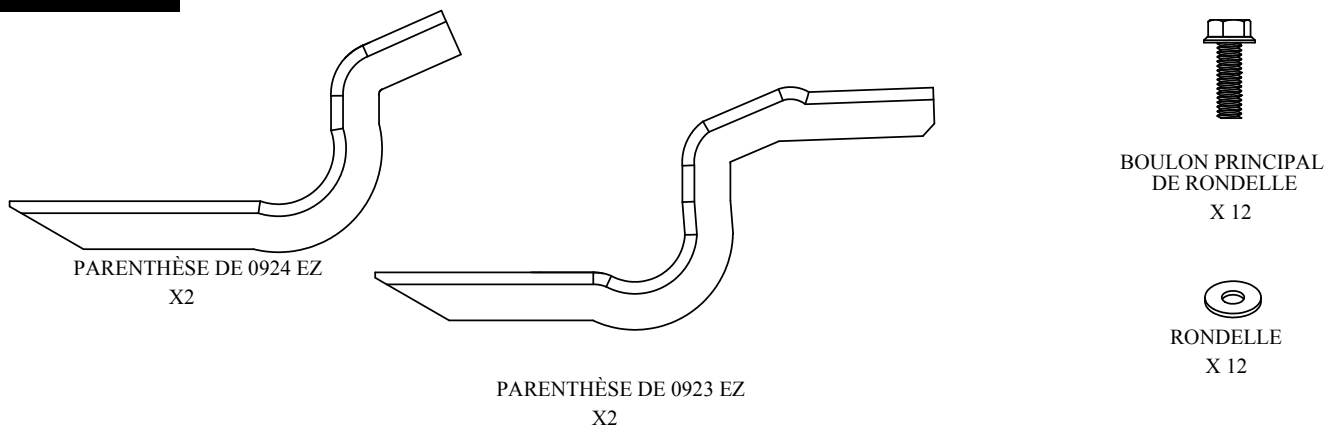

Outillage Requis

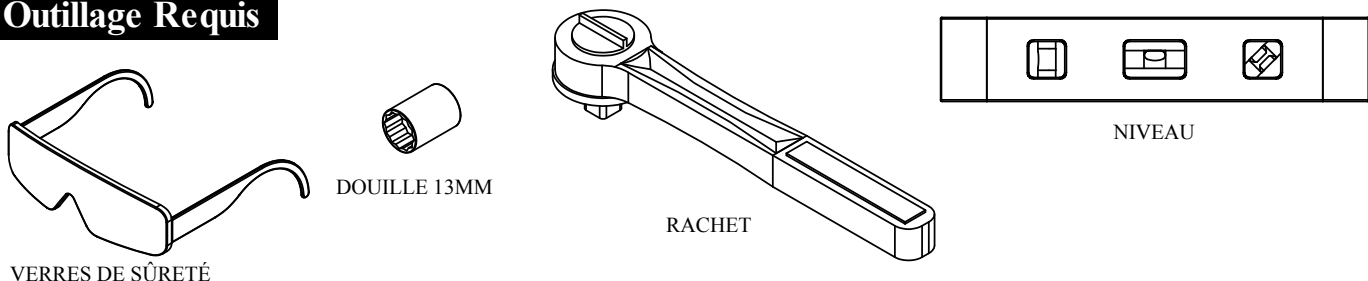

←  avant

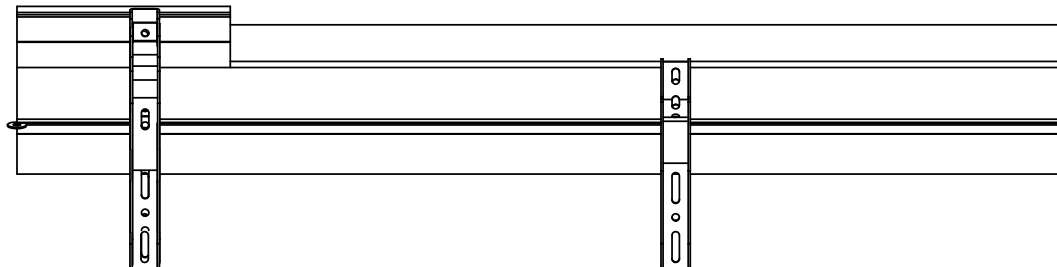

1

Côté de passager, vue inférieure

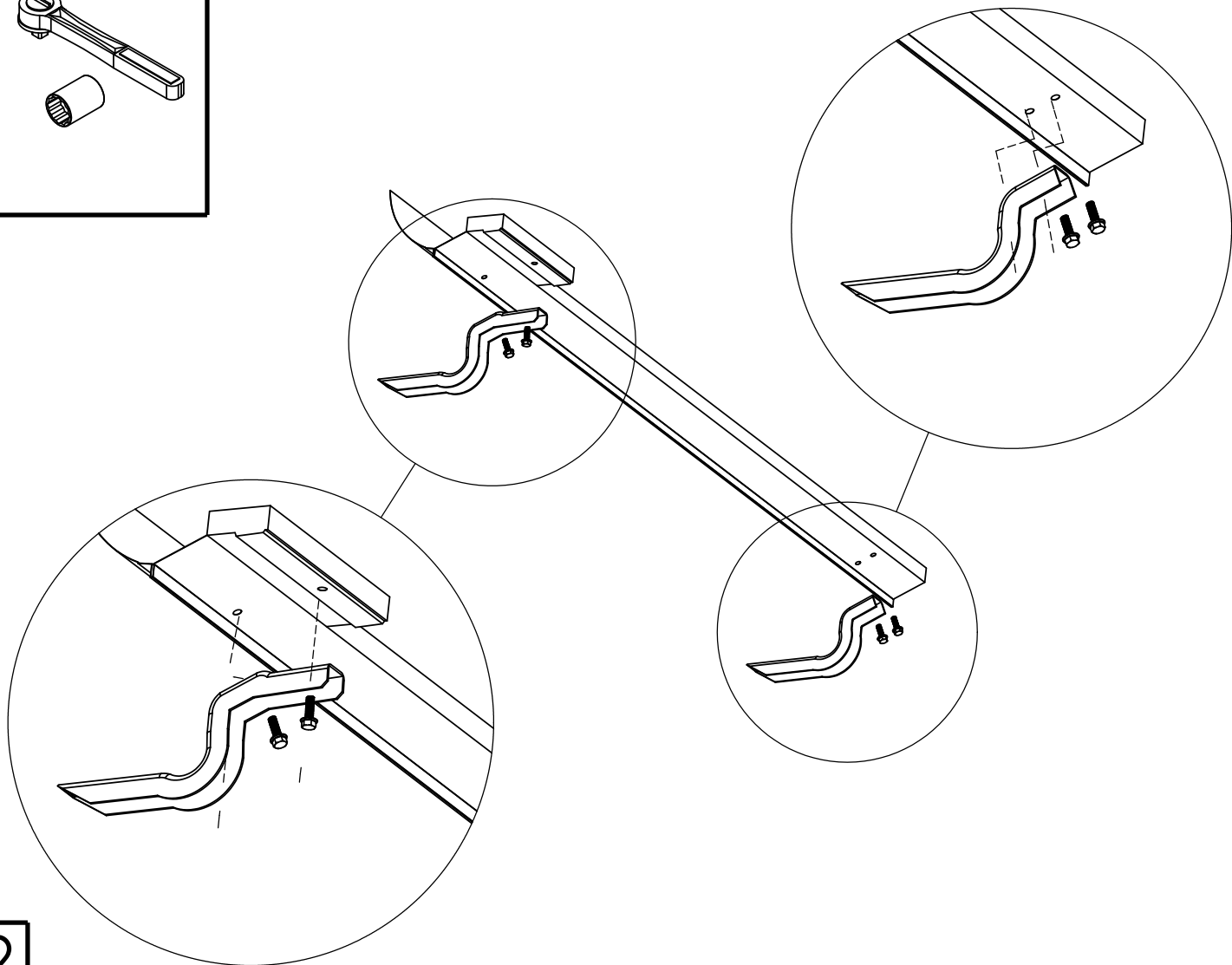
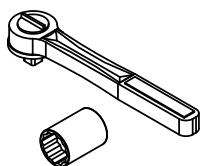

2

Employez les rondelles plates
au besoin pour s'ajuster
la parenthèse.

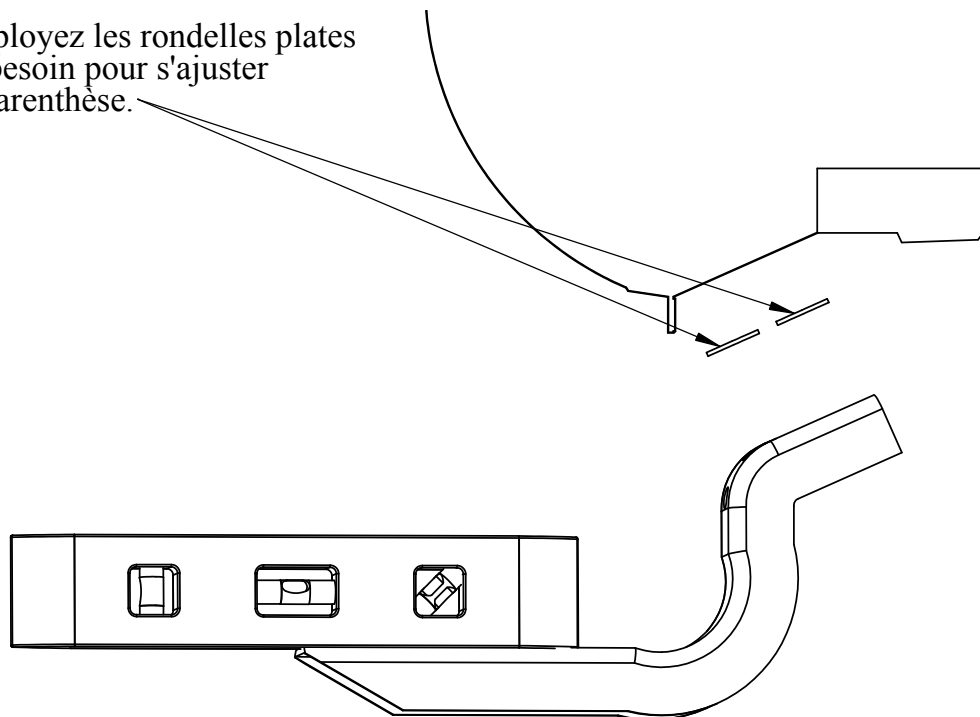

3

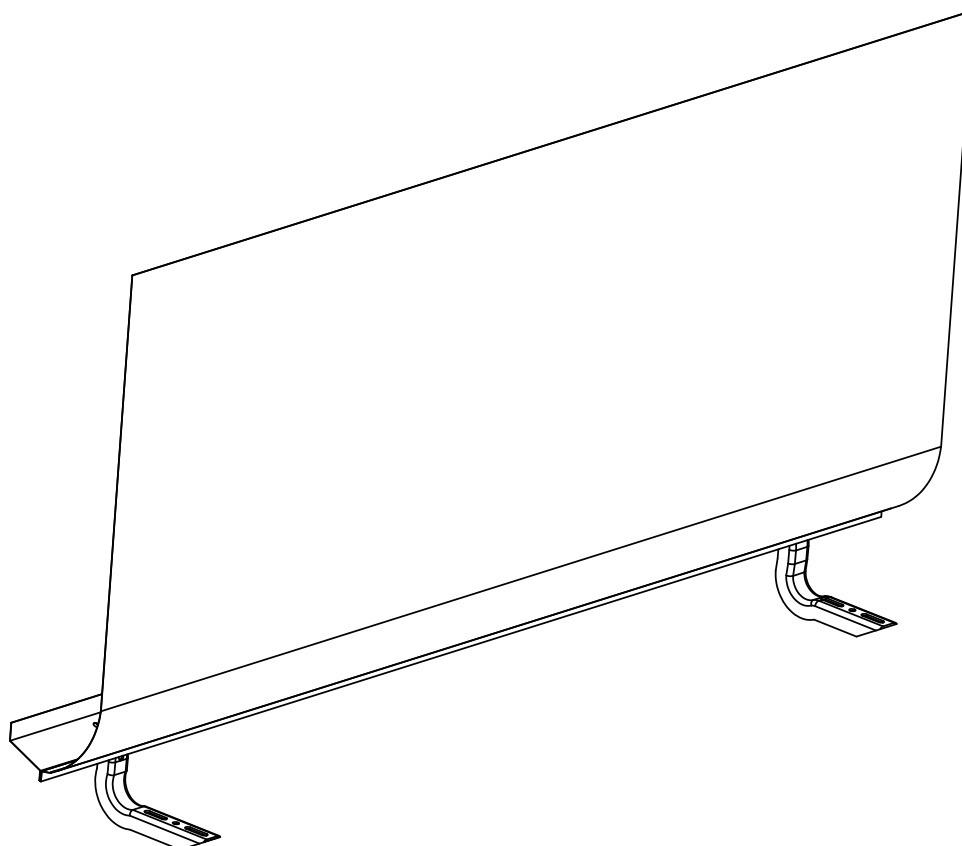

4

Félicitations

Vous avez acheté un des nombreux produits de qualité offerts par les produits marqués Lund® offerts par Lund international, Inc.. Nous prenons la plus grande fierté dans nos produits et voulez que vous appréciiez des années de satisfaction de votre investissement. Nous avons fait tout effort de s'assurer que votre produit est qualité supérieure en termes d'ajustement, longévité, finition et facilité d'installation.

Lund International, Lund Accessories Division
775 Tipton Industrial Drive, Building 2, Suite F, Lawrenceville, GA 30045
800-328-5863 • Fax 800-782-5448 • Rendez- visitenous à lundinternational.com

© 2005 Lund International, Inc. Tous droits réservés.
Lund® et Lund® le logo sont des marques déposées de Lund International, Inc.

