

# Installation Instructions

Suburban/Tahoe/  
Yukon/Yukon XL  
Kit # 300065  
10375  
Rev.1



## Lund EZ Bracket™

For proper installation and best possible fit, please read all instructions **BEFORE** you begin.

For technical assistance or to obtain missing parts, please call Customer Relations at 1-800-328-5863

### Important Safety Information



#### WARNING

- To be used with Lund branded products only.
- Do not stand on running board or EZ Bracket while vehicle is in motion.
- Do not exceed 350lbs. weight on the EZ Brackets system.
- Do not use the Lund EZ Brackets as a jacking point for vehicle.
- Do not use EZ Brackets or running boards to fasten cargo.
- Periodically check all components for tightness.



#### CAUTION

- Be sure to wear safety glasses while installing Lund EZ bracket system.
- When using power tools read and understand all operating instructions.

### Contents

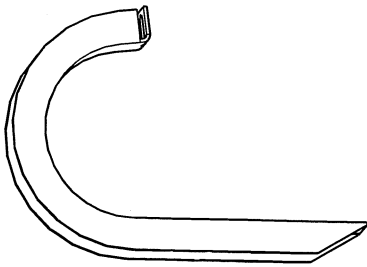

(A) EZ Bracket - 8x

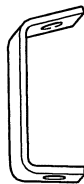

(B) Support Bracket - 8x

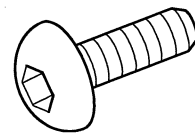

(C) Allen Head Bolt - 8x

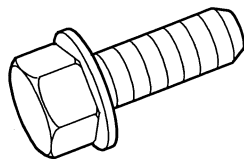

(D) Flange Bolt - 16x

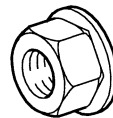

(E) Flange Nuts - 8x

**Tools Required**



6mm

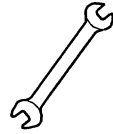

13mm



13mm

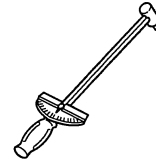

**Installation Steps**

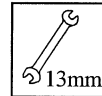

13mm

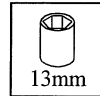

13mm

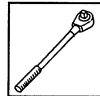

NOTE: EZ BRACKETS AND SUPPORT BRACKETS (ITEM A & ITEM B) ARE INSTALLED IN FACTORY FASTNERS LOCATED ON PINCH WELD & ROCKER PANEL AREAS OF VEHICLE.

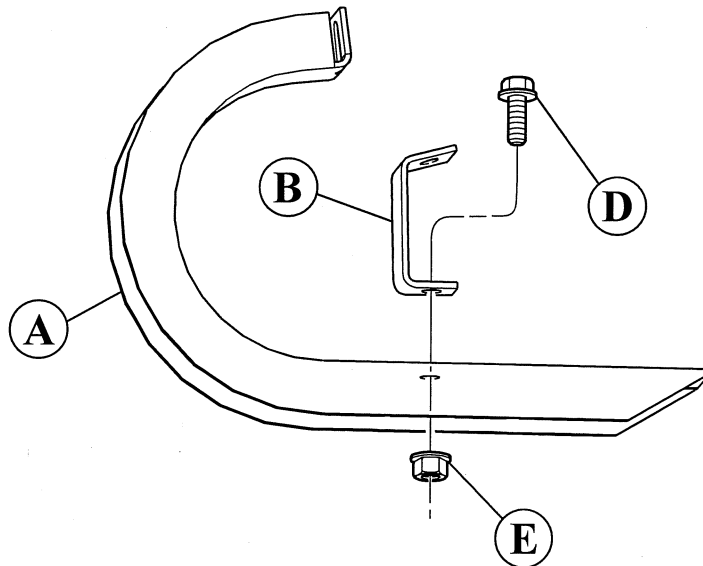

NOTE: REPEAT STEPS FOR OTHER SIDE.

Installation Steps

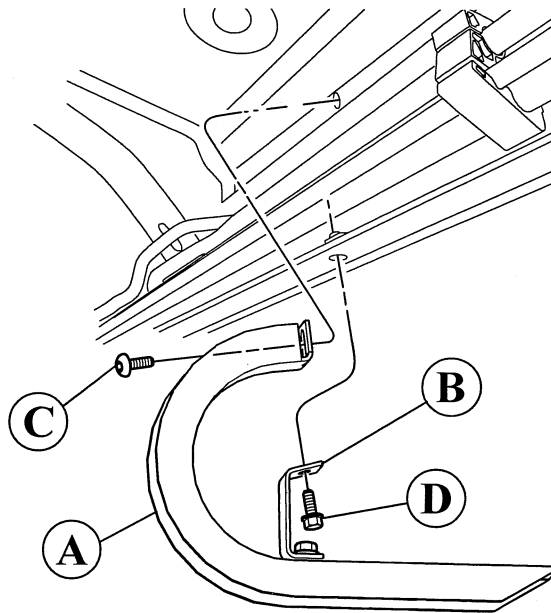
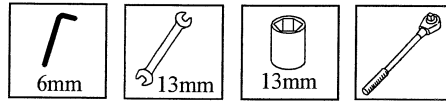
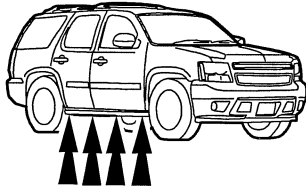

NOTE: REPEAT STEPS FOR OTHER SIDE.

2

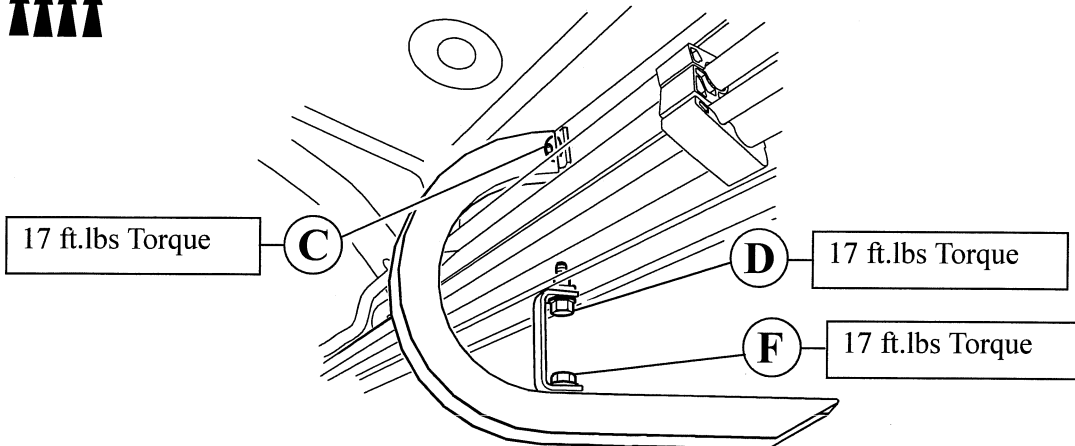
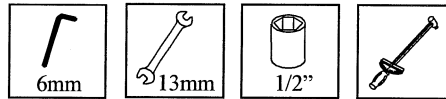
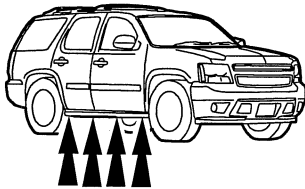

NOTE: REPEAT STEPS FOR OTHER SIDE.

3

Suburban/Tahoe/  
Yukon/Yukon XL  
Kit # 300065  
10375  
Rev.1

**Congratulations!**

You have purchased one of the many quality Lund® branded products offered by Lund International, Inc. We take the utmost pride in our products and want you to enjoy years of satisfaction from your investment. We have made every effort to ensure that your product is top quality in terms of fit, durability, finish and ease of installation.



Lund International, Lund Accessories Division  
300 Horizon Drive  
Swanee, GA 30024  
800-328-5863 • Fax 800-782-5448 • Visit us at [lundinternational.com](http://lundinternational.com)

© 2006 Lund International, Inc. All rights reserved.  
Lund ® and the Lund ® logo are trademarks of Lund International, Inc.



## Instrucciones de instalación



### Lund EZ Bracket™

Lea todas las instrucciones ANTES de comenzar para realizar la instalación correctamente y con el mejor ajuste posible.  
Para obtener asistencia técnica o reclamar piezas faltantes, llame a Atención al cliente al 1-800-328-5863.

#### Información Importante De Seguridad



#### ADVERTENCIA

- Debe utilizarse sólo con productos marca Lund.
- No se pare sobre los estribos o el soporte EZ Bracket mientras el vehículo se encuentra en movimiento.
- No coloque más de 350 libras (159 kg) de peso total sobre el sistema de soportes EZ Bracket.
- No utilice los soportes EZ Bracket de Lund como puntos de anclaje para el gato del vehículo
- No utilice los soportes EZ Bracket o los estribos para sujetar carga.
- Verifique periódicamente que todos los componentes estén bien ajustados.



#### PRECAUCIÓN

- Asegúrese de utilizar gafas de seguridad al instalar el sistema de soportes EZ Bracket de Lund.
- Al utilizar herramientas eléctricas, asegúrese de leer y comprender todas las instrucciones de funcionamiento.

#### Contenido

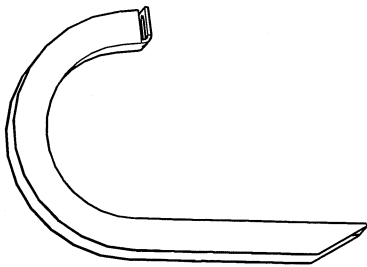

A Soporte EZ Bracket -8x

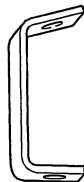

B Soporte - 8x

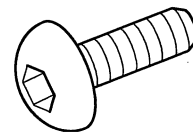

C Perno Principal De Allen - 8x

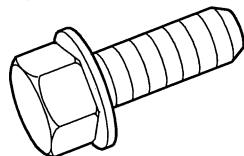

D Perno Del Reborde - 16x



E Tuercas Del Reborde -8x

### Herramientas necesarias

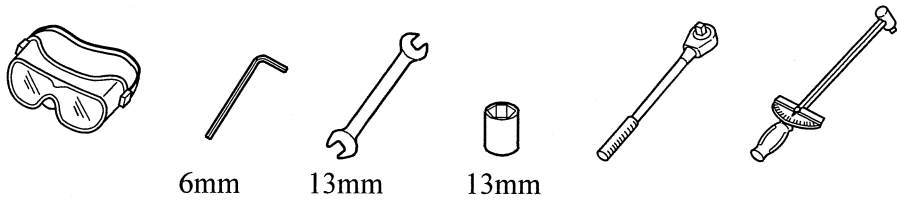

### Pasos de la instalación

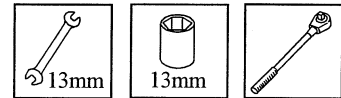

NOTA: SOPORTES de EZ Y SOPORTES (el ARTÍCULO A Y el ARTÍCULO B) ESTÁN INSTALADOS EN LA FÁBRICA FASTNERS SITUADA EN ÁREAS del PANEL de la AUTÓGENA Y del EJE DE BALANCÍN del SUJETADOR DEL VEHÍCULO.

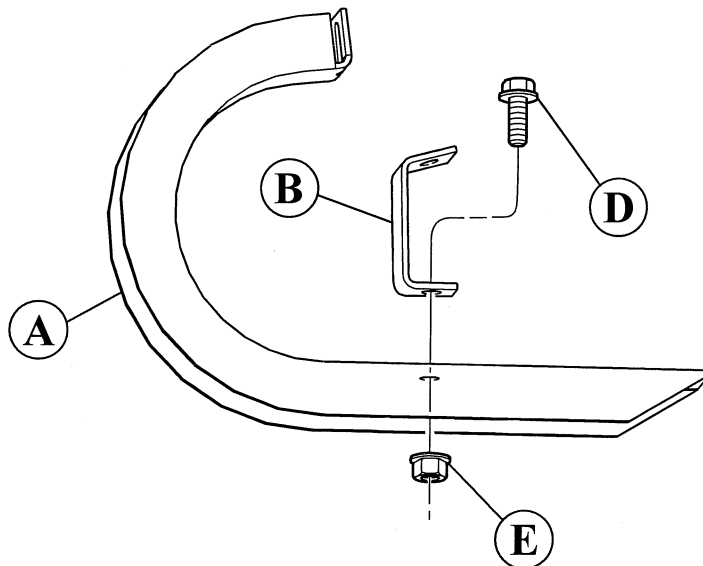

NOTA: REPITA LOS PASOS PARA EL OTRO LADO.

Pasos de la instalación

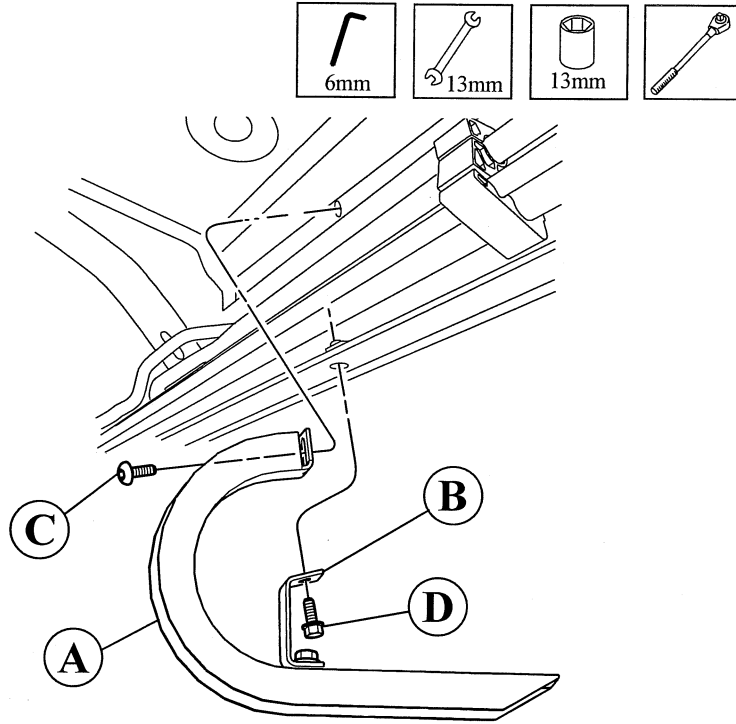
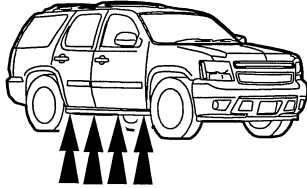

2

NOTA: REPITA LOS PASOS PARA EL OTRO LADO.

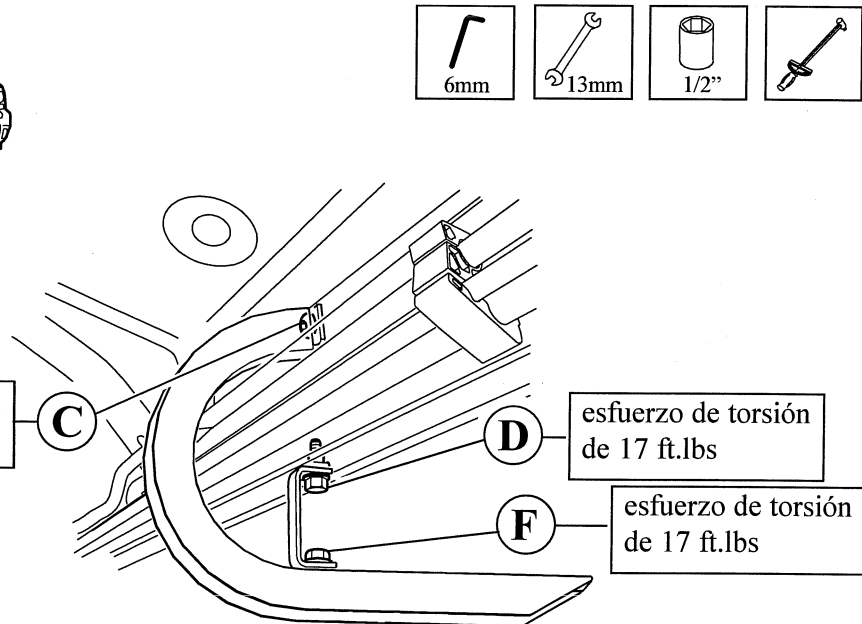
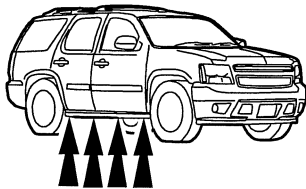

3

NOTA: REPITA LOS PASOS PARA EL OTRO LADO.

**Felicidades.**

Ha comprado uno de los tantos productos de calidad marca Lund® que ofrece Lund International, Inc. Nos sentimos muy orgullosos de nuestros productos y deseamos que disfrute durante años de su inversión. Nos hemos esforzado para asegurarnos de que su producto sea de la mejor calidad en términos de ajuste, durabilidad, acabado y facilidad de instalación.



Lund International, Lund Accessories Division  
300 Horizon Drive  
Swanee, GA 30024  
800-328-5863 • Fax 800-782-5448 • Visítenos en [lundinternational.com](http://lundinternational.com)

© 2006 Lund International, Inc, Todos los derechos reservados.  
Lund® y Lund® la insignia es marcas registradas de Lund International, Inc.





# Instructions d'installation

Suburban/Tahoe/  
Yukon/Yukon XL  
Kit n° 300065  
10375  
Rev.1



## Lund EZ Bracket™

Pour obtenir une installation correcte et le meilleur ajustement possible, lire toutes les instructions AVANT de commencer.

Pour toute assistance technique ou l'obtention de pièces manquantes, contacter le relations après-vente au 1-800-328-5863.

### L'Information Importante De Sûreté



**AVERTISSEMENT** • Ne doit être utilisé qu'avec des produits de marque Lund.

- Ne pas se tenir sur les marchepieds ou sur le support EZ Bracket lorsque le véhicule roule.
- Ne pas exercer une charge de plus de 159 kg (350 lbs) sur le système de support EZ Brackets.
- Ne pas se servir des supports EZ Brackets de Lund comme point de levage pour le véhicule.
- Ne pas se servir des supports EZ Brackets ou des marchepieds pour assujettir des cargaisons.
- Vérifier régulièrement le serrage des composants.



**ATTENTION**

- Veiller à porter des lunettes de sécurité lors de l'installation du système de support EZ Bracket de Lund.
- Lorsque des outils motorisés sont employés, lire et bien assimiler tout le mode d'emploi.

### Table des matières

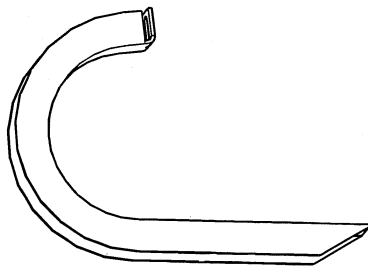

A Support EZ-Bracket - 8x

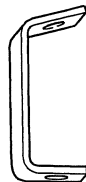

B Support - 8x

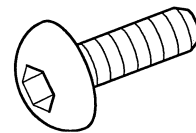

C Boulon Principal D'Allen - 8x

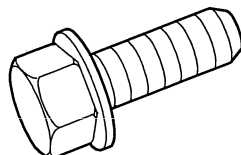

D Boulon De Bride - 16x



E Écrou à embase - 8x

**Outils nécessaires**



6mm



13mm



13mm

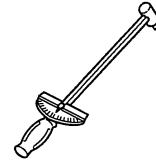

**Etapes d'installation**

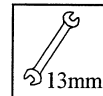

13mm

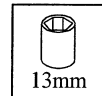

13mm



REMARQUE: PARENTHÈSES d'EZ ET SUPPORTS de SUPPORT (l'ARTICLE A Et l'ARTICLE B) SONT INSTALLÉS DANS L'USINE FASTNERS SITUÉE SUR DES RÉGIONS de PANNEAU de SOUDURE Et de CULBUTEUR de PINCEMENT DE VÉHICULE.

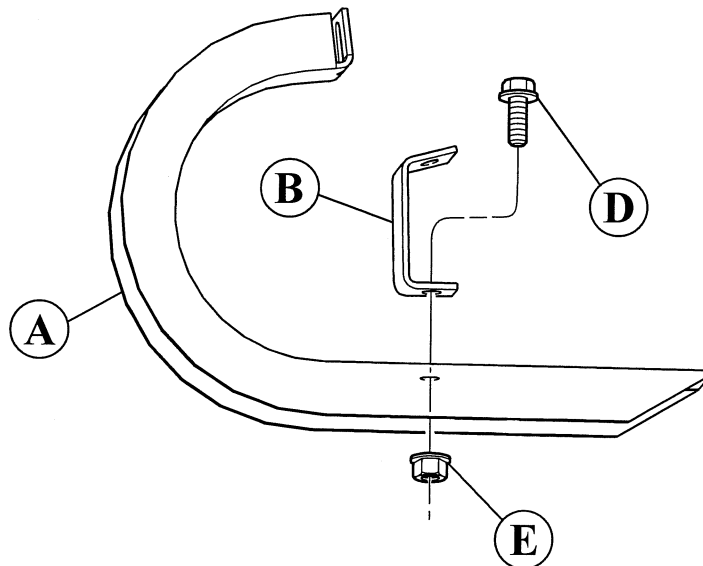

1

REMARQUE: RÉPÉTEZ LES ÉTAPES POUR L'AUTRE CÔTÉ

Etapes d'installation

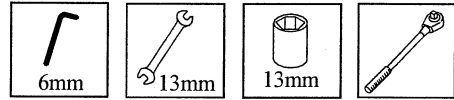
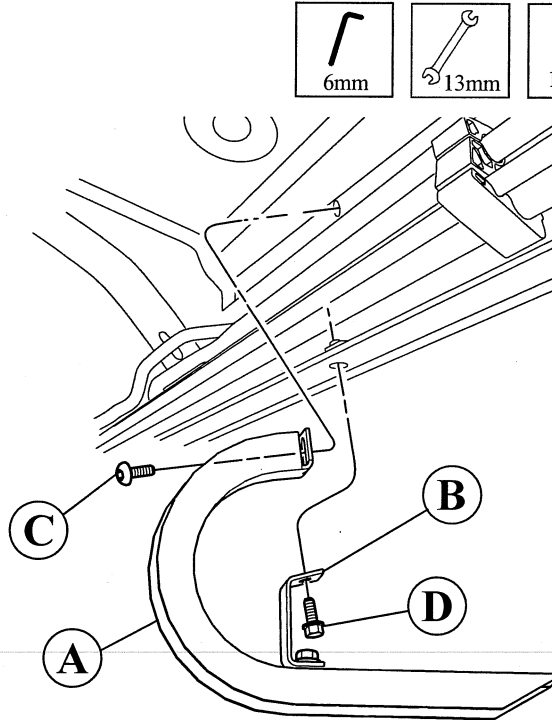
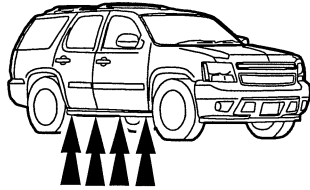

REMARQUE: RÉPÉTEZ LES ÉTAPES POUR L'AUTRE CÔTÉ

2

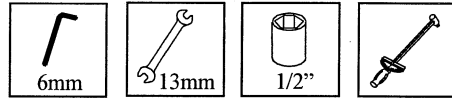
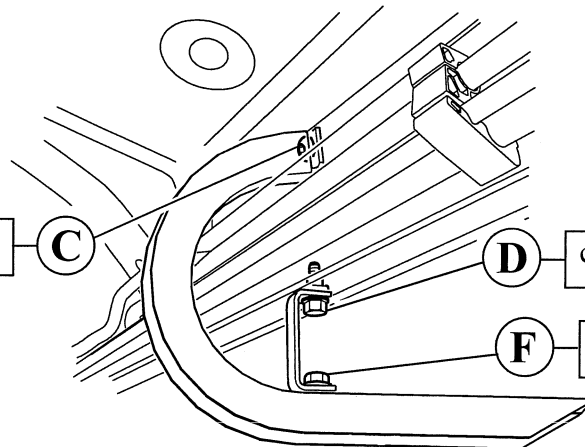
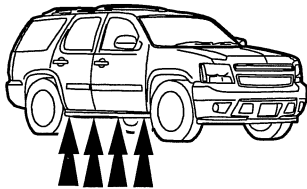

couple de 17 ft.lbs

couple de 17 ft.lbs

couple de 17 ft.lbs

REMARQUE: RÉPÉTEZ LES ÉTAPES POUR L'AUTRE CÔTÉ

3

**Félicitations !**

Vous avez acheté l'un des nombreux produits de qualité Lund® fabriqués par Lund International, Inc. Nous sommes extrêmement fiers de nos produits et souhaitons que vous tiriez des années de satisfaction de votre investissement. Nous avons pris toutes les mesures nécessaires pour assurer que ce produit est d'une qualité supérieure en ce qui concerne l'ajustement, la durabilité, la finition et la facilité d'installation.



Lund International, Lund Accessories Division  
300 Horizon Drive  
Swanee, GA 30024  
800-328-5863 • Fax 800-782-5448 • Rendez-visitenous à [lundinternational.com](http://lundinternational.com)

© 2006 Lund International, Inc, Tous droits réservés.  
Lund® et Lund® le logo sont des marques déposées de Lund International, Inc.

