



Original Bar Grille

For proper installation and best possible fit, please read all instructions **BEFORE** you begin.
For technical assistance or to obtain missing parts, please call Customer Relations at 1-800-328-5863.

Important Safety Information



CAUTION
PRECAUCIÓN
ATTENTION

To avoid risk of personal injury or property damage:

- Wear safety glasses and gloves while installing billet inserts.
- Use caution when working with any power tools.
- Check clearance on vehicle.
- Make sure that the billet inserts are secured in place and clears all moving parts of the vehicle.
- Routinely check security of hardware.
- Do not use automatic “brush-style” car washes.

Contents

Illustrations may vary upon application

Billet Grille

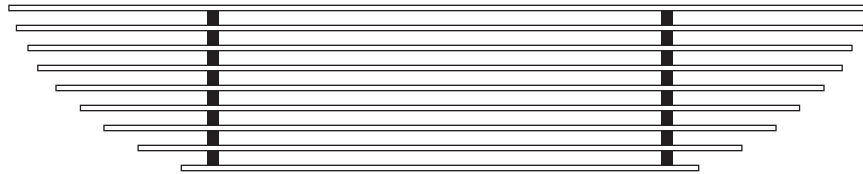

2 - 1/4x1/2" (W2)
Washers

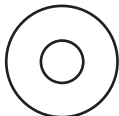

2 - 1/4x20 (N3)
Lock Nuts

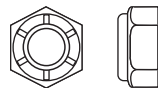

2 - 1/4-20 x 3/4"
(G51) Cap Screws

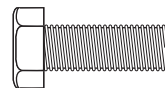

2 - 8 x 3/4" (T3)
Tek Screw

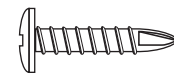

Tools Required

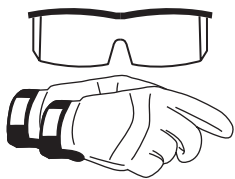

Safety Glasses
and Gloves

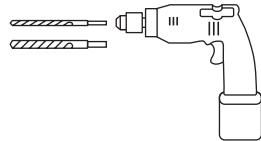

Drill with 1/8"
& 1/4" Drill Bits



Rivet Gun

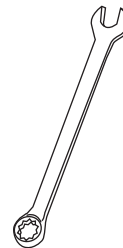

7/16" Wrench

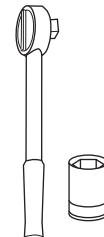

Ratchet with
7/16" Socket

Shipping Note

Sometimes the billet products get bent in the shipping process. You may need to hand bend them to attain the desired shape.

Installation Steps

Illustrations may vary upon application

Open the hood and remove the stock grille shell. Place the billet grille into place and mark where the mounting tab holes line up to the vehicle.

Top View

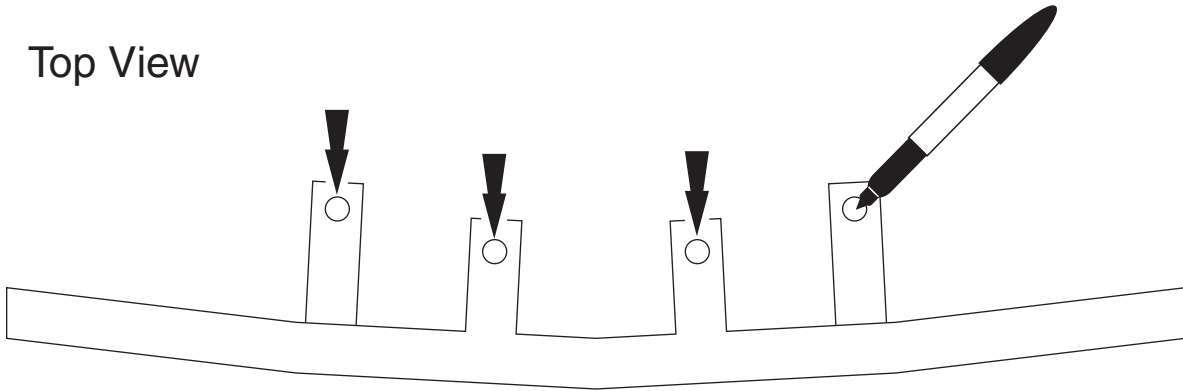

3

Drill 1/4" holes for the top mounting brackets. Drill 1/8" holes for the bottom mounting brackets.

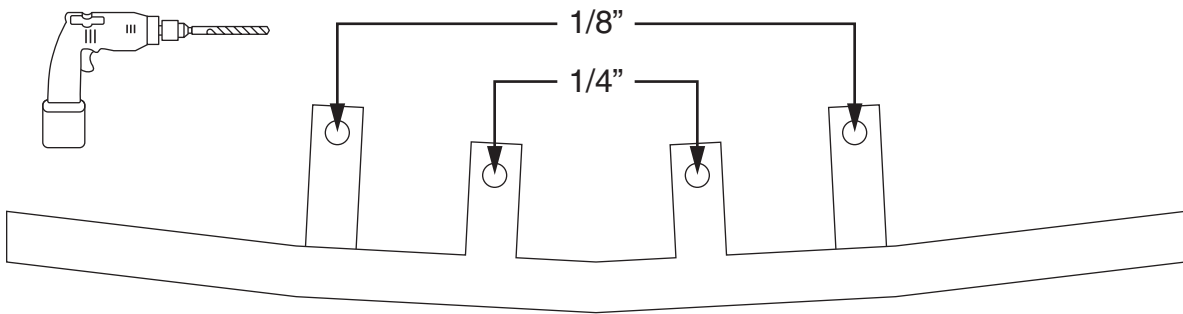

3

Secure each top mounting tab with a cap screw, washer, and lock nut. Secure each of the bottom mounting tabs with a tek screw.

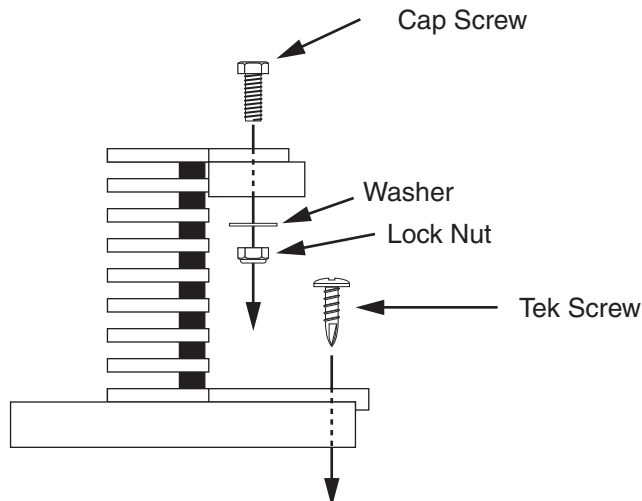

3

Care and Cleaning

To keep your billet inserts looking their best, we recommend using only mild soap and water and a soft cotton cloth to wash and dry it. Use of rough cleaning agents or cloths may scratch or dull your billet inserts.

Should your billet inserts become scratched or dull, we recommend TRENZ® Metal Polish to bring back the mirror finish. There are three grades of TRENZ® Metal Polish (Coarse, Medium and Fine) that will help you keep your billet inserts looking brand new. Select the TRENZ® Metal Polishes best for your needs:

1. Course (Red) Polish – For severe scratches and pitted problems.
2. Medium (Green) Polish – For light scratches and dulling problems.
3. Fine (White) Polish – To bring back the mirror finish.

TRENZ® Metal Polish can be used on all metal products, including aluminum, stainless steel, brass and copper. If you have additional questions or concerns on the maintenance of your Lund® billet inserts, please call us at 800-328-5863. You may also use high quality commercially available polish recommended for aluminum accessories.

Congratulations!

You have purchased one of many quality Lund® branded products offered by Lund International, Inc. We take the utmost pride in our products and want you to enjoy years of satisfaction from your investment. We have made every effort to ensure that your product is top quality in terms of fit, durability, finish and ease of installation.



Lund International, Lund Accessories Division
775 Tipton Industrial Drive, Building 2, Suite F
Lawrenceville, GA 30045

Phone 800-328-5863 • Fax 800-782-5448 • Visit us at lundinternational.com

© 2005 Lund International, Inc. All rights reserved.
Lund® and the Lund® logo are trademarks of Lund International, Inc.

