



## Original Bar Grille

For proper installation and best possible fit, please read all instructions **BEFORE** you begin.  
For technical assistance or to obtain missing parts, please call Customer Relations at 1-800-328-5863.

### Important Safety Information



CAUTION  
PRECAUCIÓN  
ATTENTION

#### To avoid risk of personal injury or property damage:

- Wear safety glasses and gloves while installing billet inserts.
- Use caution when working with any power tools.
- Check clearance on vehicle.
- Make sure that the billet inserts are secured in place and clears all moving parts of the vehicle.
- Routinely check security of hardware.
- Do not use automatic “brush-style” car washes.

### Contents

Illustrations may vary upon application

Billet Grille

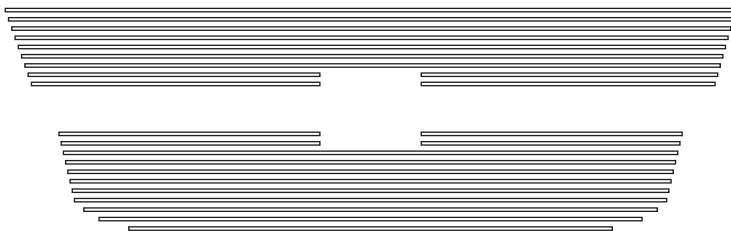

8 - 1/8 x 5/8” (R1) Pop Rivets

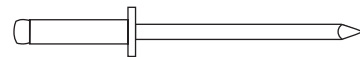

8 - 3/4 x 3/4” Billet Squares



### Tools Required

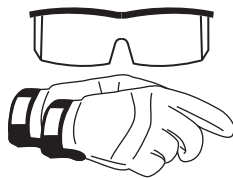

Safety Glasses  
and Gloves

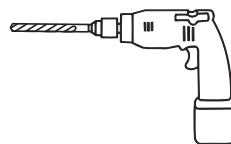

Drill with  
1/8” Drill Bit



Rivet Gun

### Shipping Note

Sometimes the billet products get bent in the shipping process. You may need to hand bend them to attain the desired shape.

### Caution

Grille covers may reduce airflow which may result in higher operating temperatures. Monitor your vehicle’s operating temperature to ensure proper operating conditions.

## Installation Steps

Illustrations may vary upon application

Remove the stock grille shell. Place billet grille into place from the front, mounting one grille at a time.

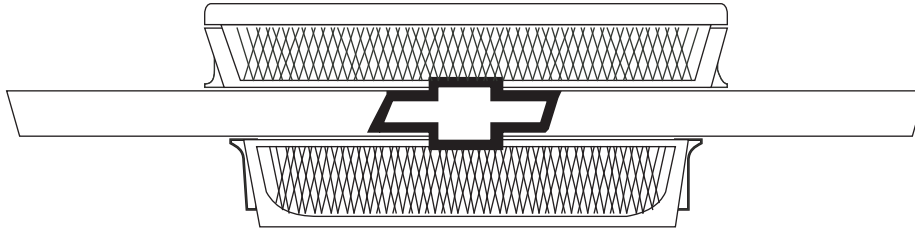

1

From the back of the grille shell, drill and rivet into place using the included billet squares.

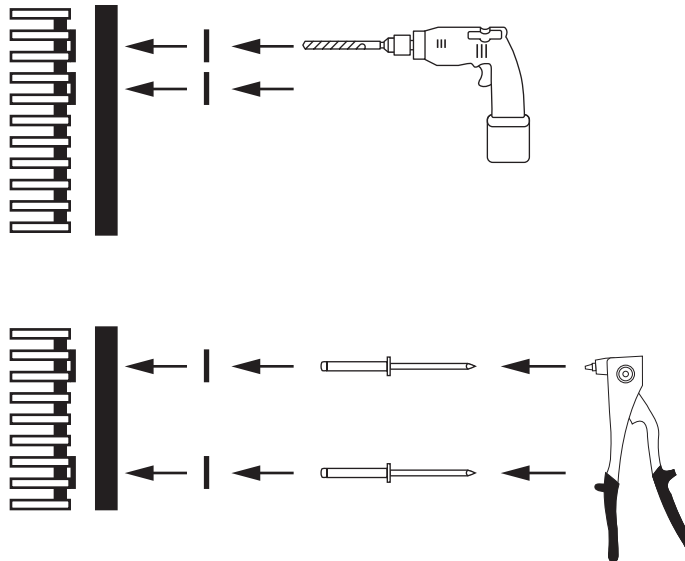

2

Reinstall the grille shell.

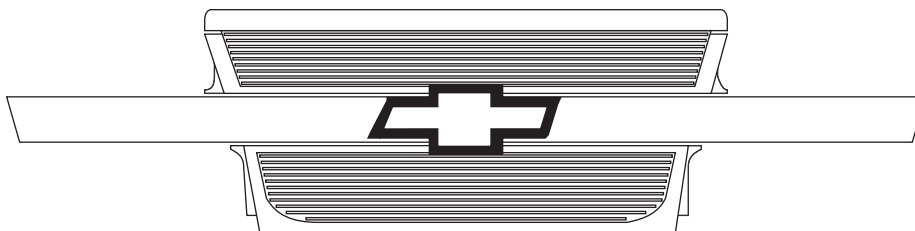

3

## Care and Cleaning

To keep your billet inserts looking their best, we recommend using only mild soap and water and a soft cotton cloth to wash and dry it. Use of rough cleaning agents or cloths may scratch or dull your billet inserts.

Should your billet inserts become scratched or dull, we recommend TRENZ® Metal Polish to bring back the mirror finish. There are three grades of TRENZ® Metal Polish (Coarse, Medium and Fine) that will help you keep your billet inserts looking brand new. Select the TRENZ® Metal Polishes best for your needs:

1. Course (Red) Polish – For severe scratches and pitted problems.
2. Medium (Green) Polish – For light scratches and dulling problems.
3. Fine (White) Polish – To bring back the mirror finish.

TRENZ® Metal Polish can be used on all metal products, including aluminum, stainless steel, brass and copper. If you have additional questions or concerns on the maintenance of your Lund® billet inserts, please call us at 800-328-5863. You may also use high quality commercially available polish recommended for aluminum accessories.

## Congratulations!

You have purchased one of many quality Lund® branded products offered by Lund International, Inc. We take the utmost pride in our products and want you to enjoy years of satisfaction from your investment. We have made every effort to ensure that your product is top quality in terms of fit, durability, finish and ease of installation.



Lund International, Lund Accessories Division  
775 Tipton Industrial Drive, Building 2, Suite F  
Lawrenceville, GA 30045

Phone 800-328-5863 • Fax 800-782-5448 • Visit us at [lundinternational.com](http://lundinternational.com)

© 2005 Lund International, Inc. All rights reserved.  
Lund® and the Lund® logo are trademarks of Lund International, Inc.

