



Original Bar Grille

For proper installation and best possible fit, please read all instructions **BEFORE** you begin.
For technical assistance or to obtain missing parts, please call Customer Relations at 1-800-328-5863.

Important Safety Information



CAUTION
PRECAUCIÓN
ATTENTION

To avoid risk of personal injury or property damage:

- Wear safety glasses and gloves while installing billet inserts.
- Use caution when working with any power tools.
- Check clearance on vehicle.
- Make sure that the billet inserts are secured in place and clears all moving parts of the vehicle.
- Routinely check security of hardware.
- Do not use automatic “brush-style” car washes.

Contents

Illustrations may vary upon application

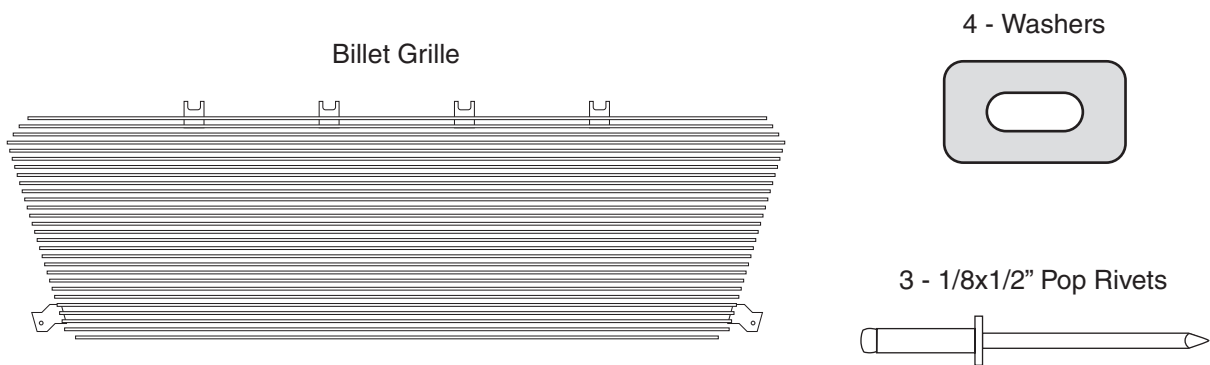

Tools Required



Safety Glasses
and Gloves

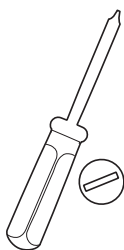

Flat Head
Screwdriver

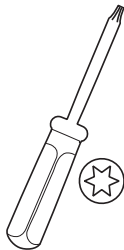

T-20 Torx
Screwdriver

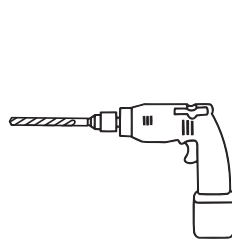

Drill with
1/8" Drill Bit



Rivet Gun

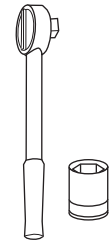

Ratchet with
10mm Socket

Shipping Note

Sometimes the billet products get bent in the shipping process. You may need to hand bend them to attain the desired shape.

Installation Steps

Illustrations may vary upon application

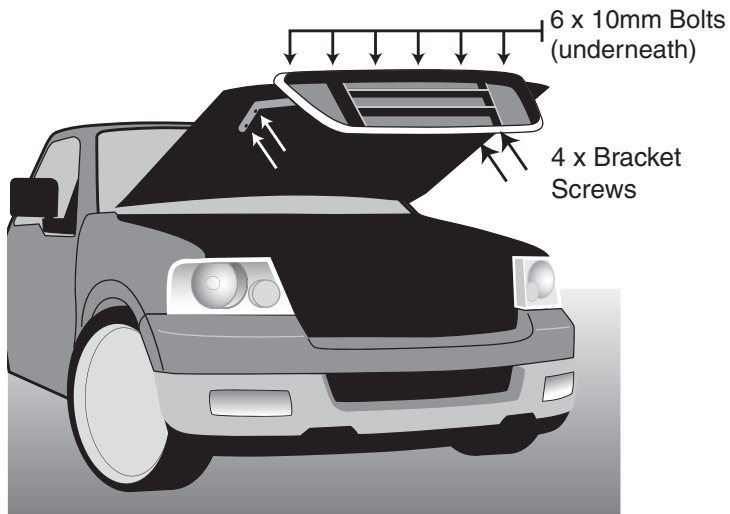

Pop open the hood. Using a 10mm socket, loosen and remove the 6 bolts along the top of the grille shell that hold it to the under side of the hood. Using a Phillips screwdriver, loosen and remove the two screws on each of the two side braces that are mounted to the hood. Pull the grille shell out.

1

On the back of the grille shell, use a T-20 star key and remove the two screws that hold each of the two side braces to the grille shell. Save the braces and hardware for later installation.

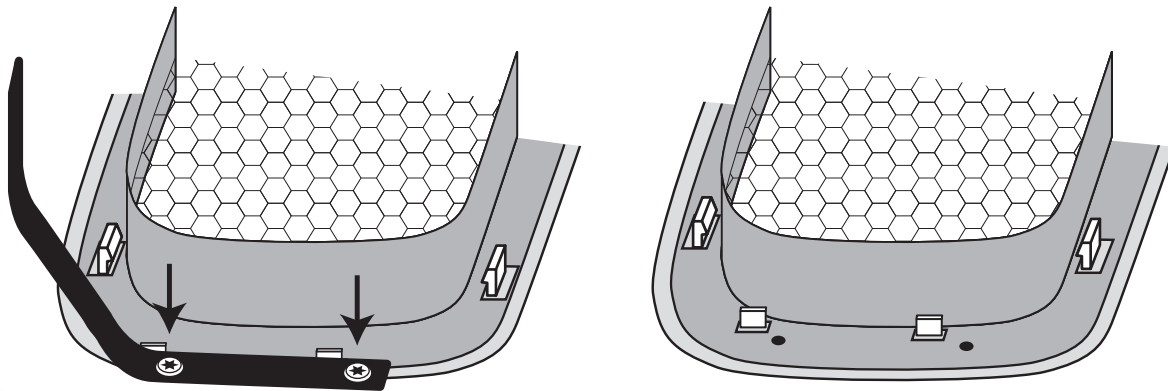

2

Remove the black inner shell from the chrome/painted ring by prying back the retainer clips and pulling out the inner shell. Note: Some tabs may need to be removed to allow proper fit of the Billet Grille. Set the chrome/painted ring aside for later installation.

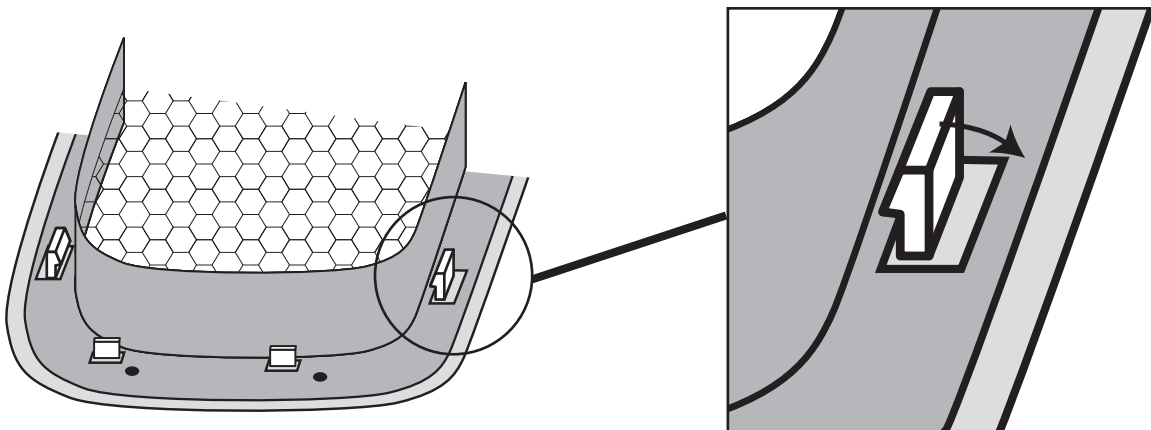

3

Using the two of the four T20 Torx screws you removed earlier, attach the steel braces to the billet grille side brackets.

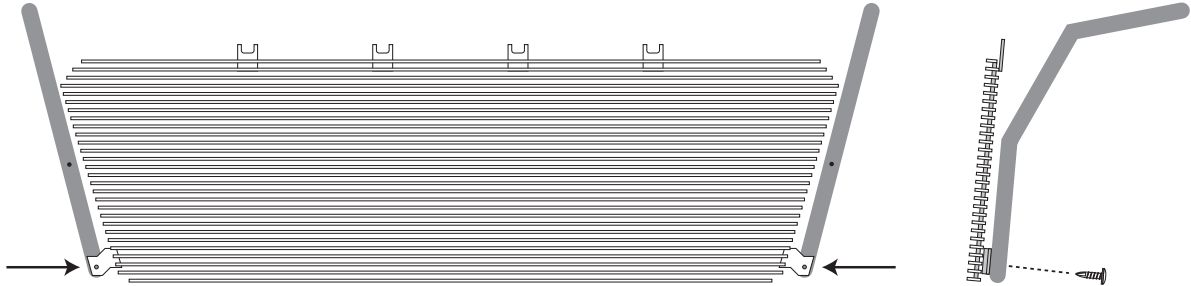

4

Slide the Billet Grille onto the hood so that the lip of the hood slides between the tabs and the bars of the Billet Grille. Note: This will be a tight fit! Line up the 4 Billet Grille tabs with the center 4 holes on the hood.

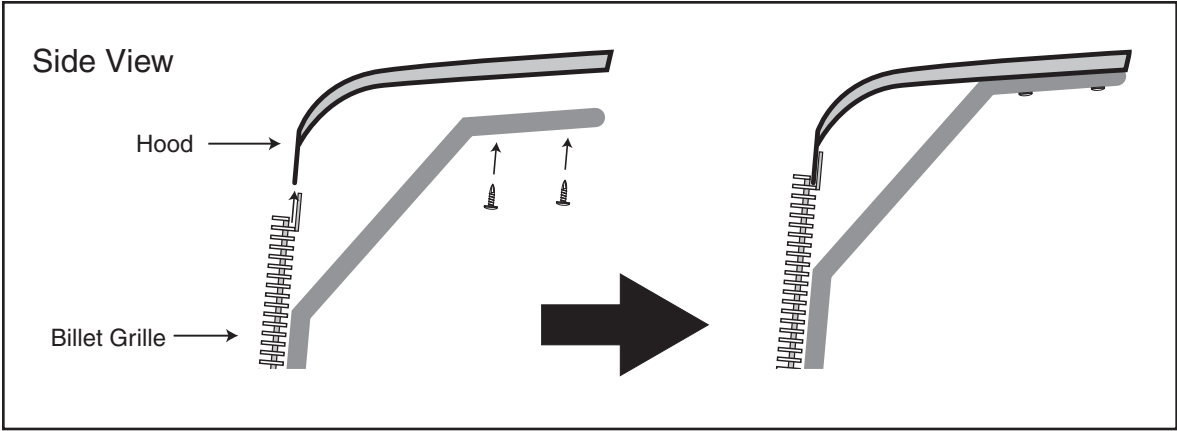
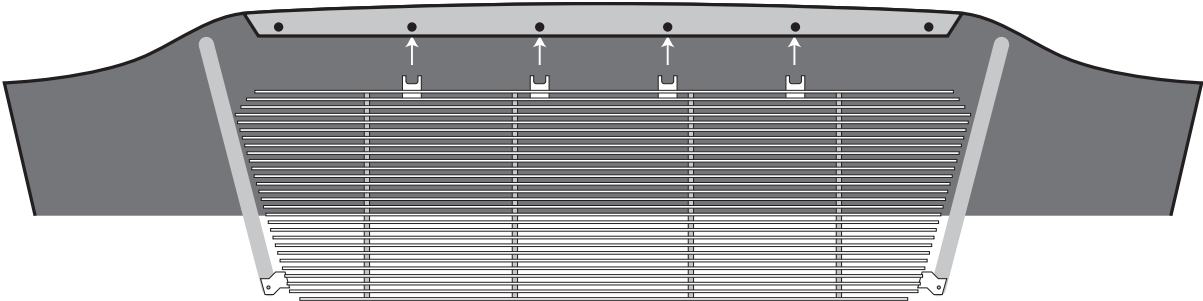

5

Reattach the stock chrome/painted ring using the provided aluminum washers and stock nuts. The four washers should be used with the four Billet Grille tabs. Hand tighten the nuts and adjust the position of the Billet Grille for the best fit. Once it has a good fit, tighten all the nuts with a 10mm socket.

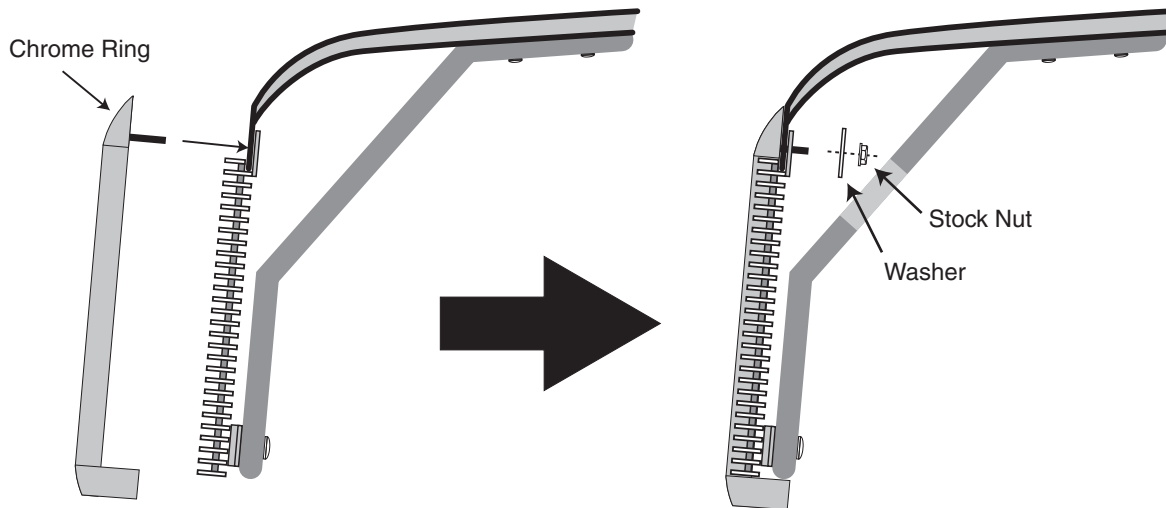

6

Using a 1/8" drill bit, drill through each of the three bottom Billet Grille tabs and through the grille shell. Note: do not force the chrome/painted ring back towards the truck - this will warp the ring. Rivet the tabs to the grille shell using the provided rivets.

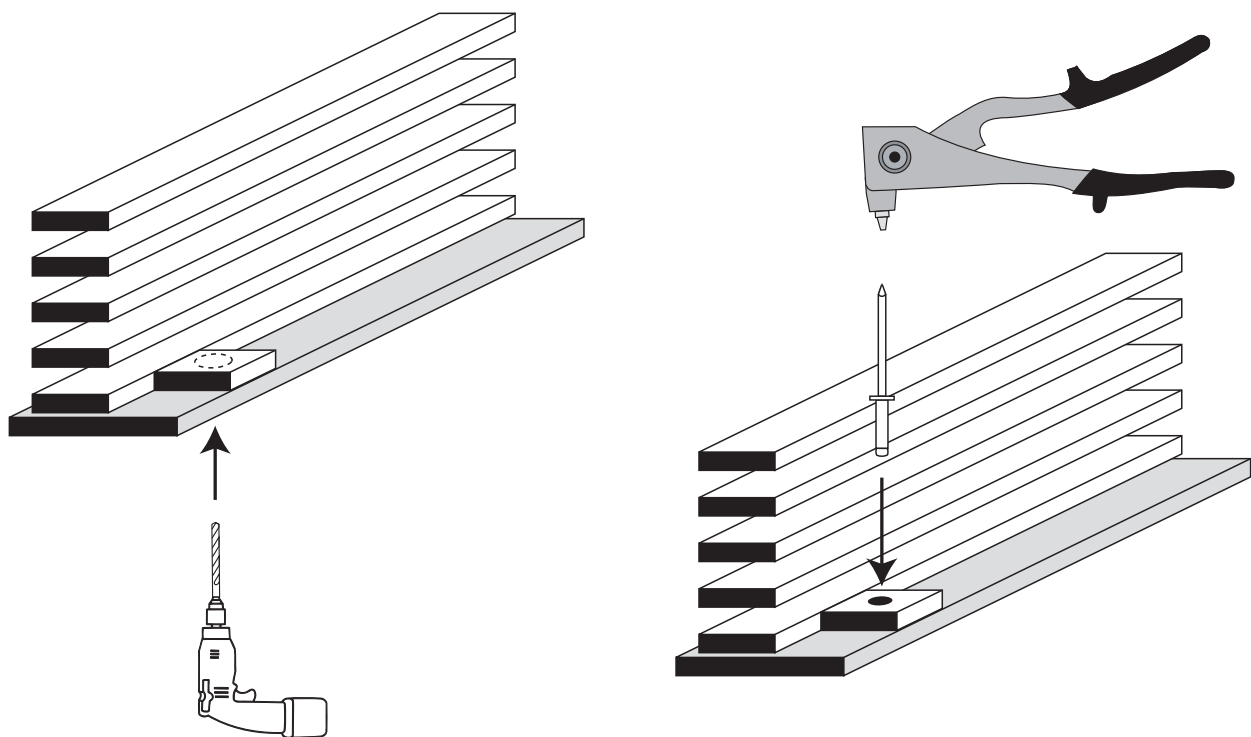

7

Inspection After Installation

Make sure everything is secure and close the hood. Enjoy your award-winning product you have just installed!

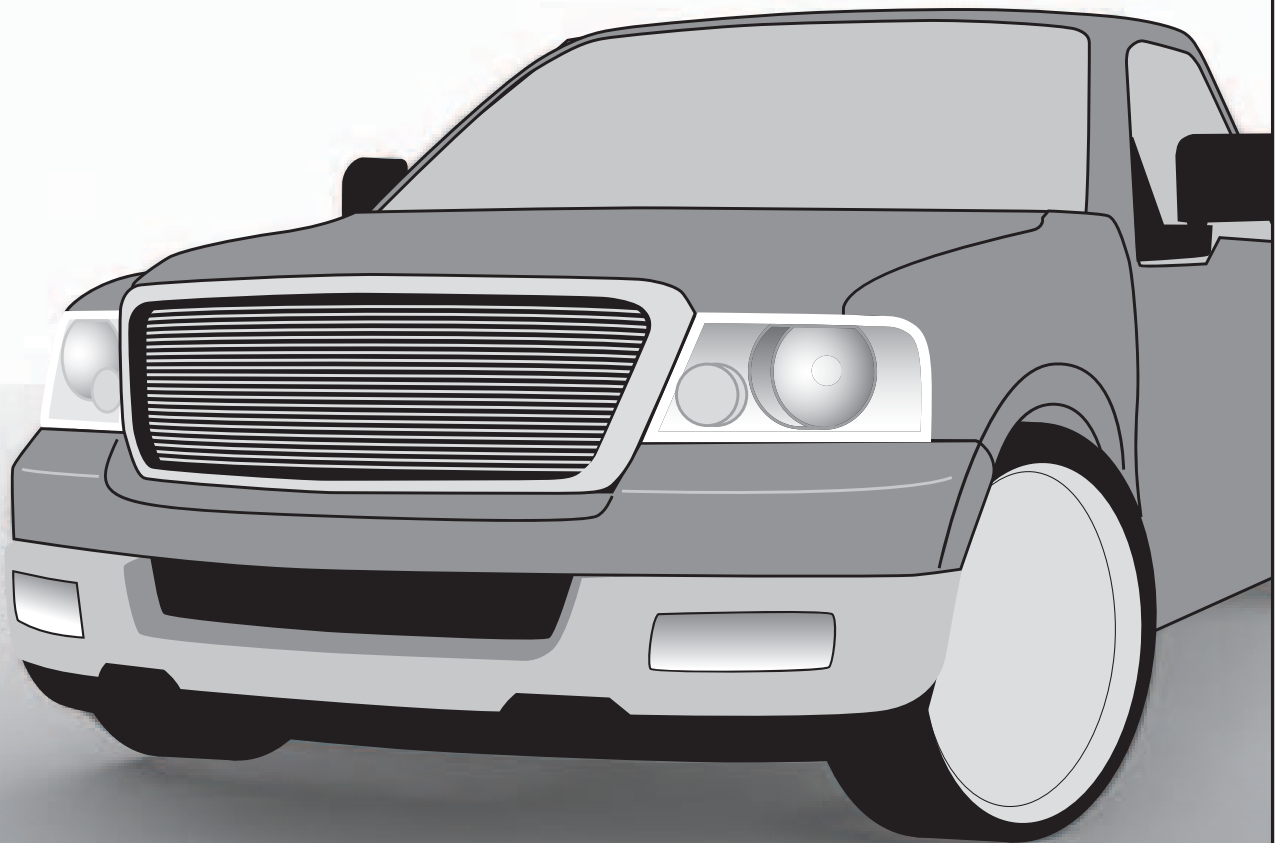

Care and Cleaning

To keep your billet inserts looking their best, we recommend using only mild soap and water and a soft cotton cloth to wash and dry it. Use of rough cleaning agents or cloths may scratch or dull your billet inserts.

Should your billet inserts become scratched or dull, we recommend Lund® Metal Polish to bring back the mirror finish. There are three grades of Lund® Metal Polish (Coarse, Medium and Fine) that will help you keep your billet inserts looking brand new. Select the Lund® Metal Polishes best for your needs:

1. Course (Red) Polish – For severe scratches and pitted problems.
2. Medium (Green) Polish – For light scratches and dulling problems.
3. Fine (White) Polish – To bring back the mirror finish.

Lund® Metal Polish can be used on all metal products, including aluminum, stainless steel, brass and copper. If you have additional questions or concerns on the maintenance of your Lund® billet inserts, please call us at 800-328-5863. You may also use high quality commercially available polish recommended for aluminum accessories.

Congratulations!

You have purchased one of many quality Lund® branded products offered by Lund International, Inc. We take the utmost pride in our products and want you to enjoy years of satisfaction from your investment. We have made every effort to ensure that your product is top quality in terms of fit, durability, finish and ease of installation.



Lund International, Lund Accessories Division
775 Tipton Industrial Drive, Building 2, Suite F
Lawrenceville, GA 30045

Phone 800-328-5863 • Fax 800-782-5448 • Visit us at lundinternational.com

© 2005 Lund International, Inc. All rights reserved.
Lund® and the Lund® logo are trademarks of Lund International, Inc.

