

Care and Cleaning

To keep your billet grille looking their best, we recommend using only mild soap and water and a soft cotton cloth to wash and dry it. Use of rough cleaning agents or cloths may scratch or dull your billet grille.

Should your billet grille become scratched or dull, we recommend TRENZ® Metal Polish to bring back the mirror finish. There are three grades of TRENZ® Metal Polish (Coarse, Medium and Fine) that will help you keep your billet grille looking brand new. Select the TRENZ® Metal Polishes best for your needs:

1. Course (Red) Polish – For severe scratches and pitted problems.
2. Medium (Green) Polish – For light scratches and dulling problems.
3. Fine (White) Polish – To bring back the mirror finish.

TRENZ® Metal Polish can be used on all metal products, including aluminum, stainless steel, brass and copper. If you have additional questions or concerns on the maintenance of your Lund® billet grille, please call us at 800-328-5863. You may also use high quality commercially available polish recommended for aluminum accessories.

Congratulations!

You have purchased one of many quality Lund® branded products offered by Lund International, Inc. We take the utmost pride in our products and want you to enjoy years of satisfaction from your investment. We have made every effort to ensure that your product is top quality in terms of fit, durability, finish and ease of installation.



Lund International, Lund Accessories Division
775 Tipton Industrial Drive, Building 2, Suite F
Lawrenceville, GA 30045

Phone 800-328-5863 • Fax 800-782-5448 • Visit us at lundinternational.com

© 2005 Lund International, Inc. All rights reserved.

Lund® and the Lund® logo are trademarks of Lund International, Inc.



Original Bar Grille



For proper installation and best possible fit, please read all instructions BEFORE you begin.
For technical assistance or to obtain missing parts, please call Customer Relations at 1-800-328-5863.

Important Safety Information



CAUTION
PRECAUCIÓN
ATTENTION

To avoid risk of personal injury or property damage:

- Wear safety glasses and gloves while installing billet inserts.
- Use caution when working with any power tools.
- Check clearance on vehicle.
- Make sure that the billet inserts are secured in place and clears all moving parts of the vehicle.
- Routinely check security of hardware.
- Do not use automatic “brush-style” car washes.

Contents Illustrations may vary upon application

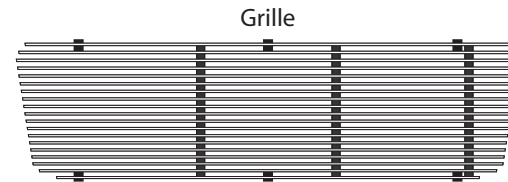

Grille

6 - 1/8" x 1/2" Pop Rivets

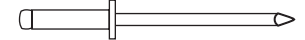

Tools Required

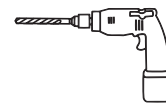

Drill with
1/8" Drill Bit

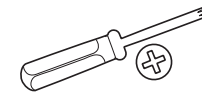

Phillips
Screwdriver

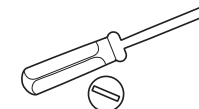

Flat Head
Screwdriver



Rivet Gun

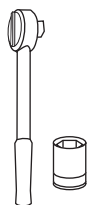

Ratchet with
10mm Socket



Safety Glasses
and Gloves



Die Grinder

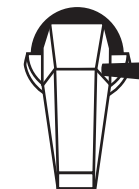

Angle Grinder

Shipping Note

Sometimes the billet products get bent in the shipping process. You may need to hand bend them to attain the desired shape.



Installation Steps Illustrations may vary upon application

Pop open the hood and remove all seven (7) of the stock black plastic rivets across the radiator cover by prying up the center of the rivet with a flat head screwdriver. Put the rivets aside for reinstallation.

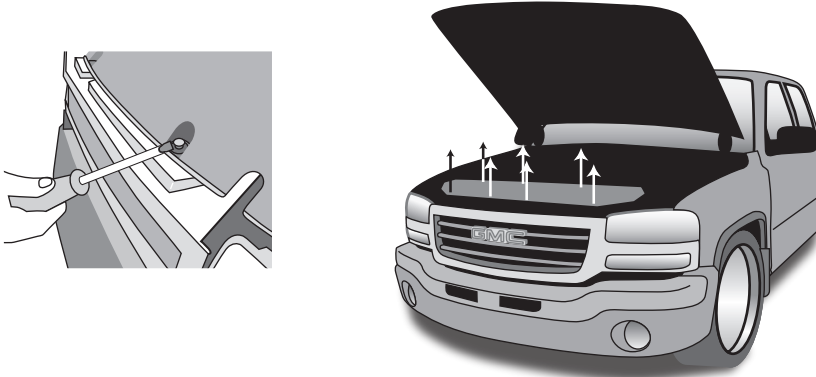

After removing the plastic rivets, pop the black radiator cover off the top of the grille shell and set aside to replace after grille is installed.

1

Using a Phillips screwdriver, turn each of the 4 plastic screws a quarter turn to loosen the center of the grille shell.

To release the side clips, pull the center bar out just enough to slide a flat head screwdriver between the grille shell and the fender. Be extremely careful in between the grille shell and the fender. Touching the side clip, very carefully turn the handle of the screwdriver to pull the side clip out.

Using a 10mm socket, remove the center bolt on the top of the stock grille shell.

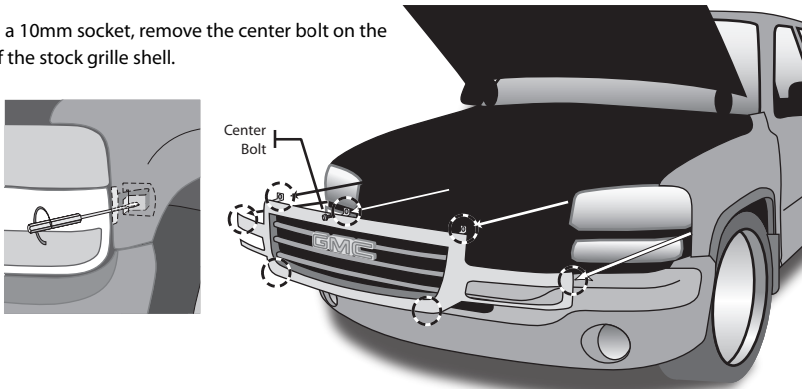

Pull the stock grille shell towards you to remove it from the vehicle. Then place the stock grille shell face down. Make sure to work on a flat, non-abrasive surface, blanket or towel to prevent scratching.

2

Using either a Die Grinder or Hacksaw, cut away the horizontal and vertical bars of the inner webbing. Next, use an Angle Grinder or Sander to sand away any of the webbing that may be left over. Be careful not to scratch the chrome ring.

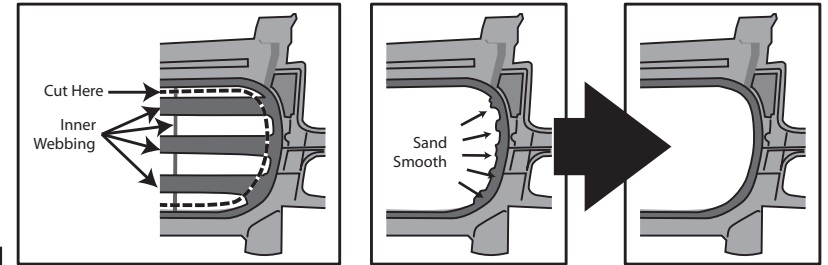

3

Insert the Billet Grille from the front of the stock grille shell. Make sure that it is centered and fits flush against the grille shell. Once the Billet Grille is in place, locate the 3 top tabs. Drill through the tabs and the grille shell using a 1/8" drill bit to make a rivet hole. Rivet the tabs and shell together.

Locate the 3 bottom tabs. Drill through the tabs and the grille shell using a 1/8" drill bit to make a rivet hole. Rivet the tabs and shell together.

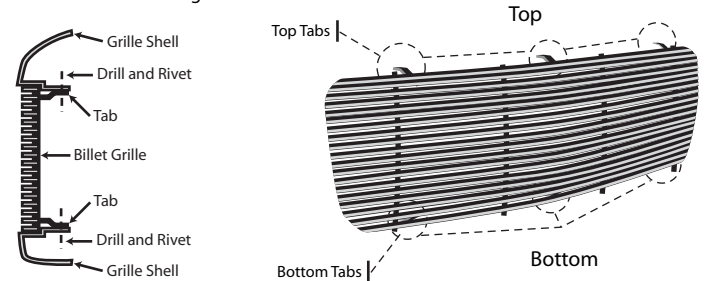

4

Reinstall the stock shell with your new Billet Grille onto the vehicle. Place the grille shell back on the vehicle and line up the side clips and clip back in place. Tighten the 4 plastic screws, screw the center bolt back into place. Replace the radiator cover and fasten with the 7 stock rivets. Make sure everything is secure and close the hood. Enjoy your award-winning product that you have just installed!

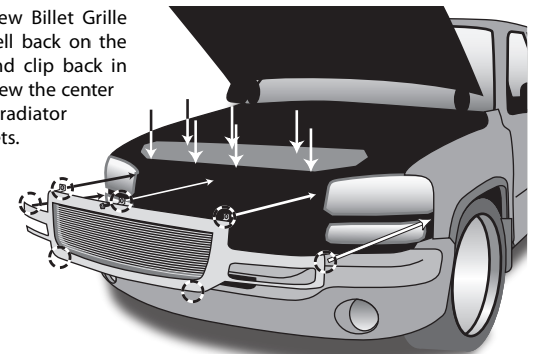

5