



Framed Perimeter Grille

For proper installation and best possible fit, please read all instructions **BEFORE** you begin.
For technical assistance or to obtain missing parts, please call Customer Relations at 1-800-328-5863.

Important Safety Information



CAUTION
PRECAUCIÓN
ATTENTION

To avoid risk of personal injury or property damage:

- Wear safety glasses and gloves while installing billet inserts.
- Use caution when working with any power tools.
- Check clearance on vehicle.
- Make sure that the billet inserts are secured in place and clears all moving parts of the vehicle.
- Routinely check security of hardware.
- Do not use automatic “brush-style” car washes.

Contents

Illustrations may vary upon application

Billet Grille

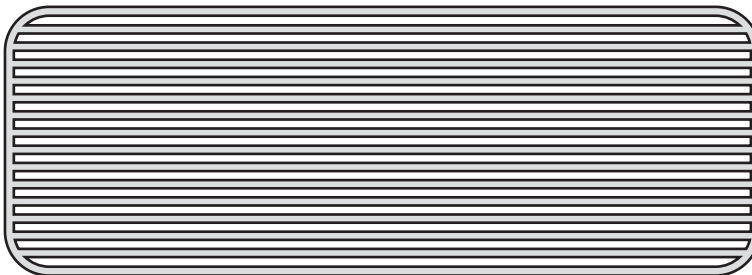

2 - Slider Tabs



2 - Hair Pin Clips

Tools Required

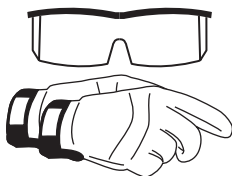

Safety Glasses
and Gloves

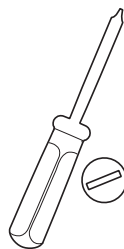

Flat Head
Screwdriver

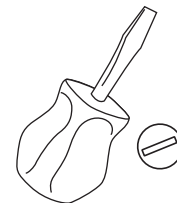

Short Flat Head
Screwdriver

Shipping Note

Sometimes the billet products get bent in the shipping process. You may need to hand bend them to attain the desired shape.

Open the hood. Use a flat head screwdriver to release the four plastic retainer clips. To release them, turn each one 45 degrees so the head can slip through the hole behind it.

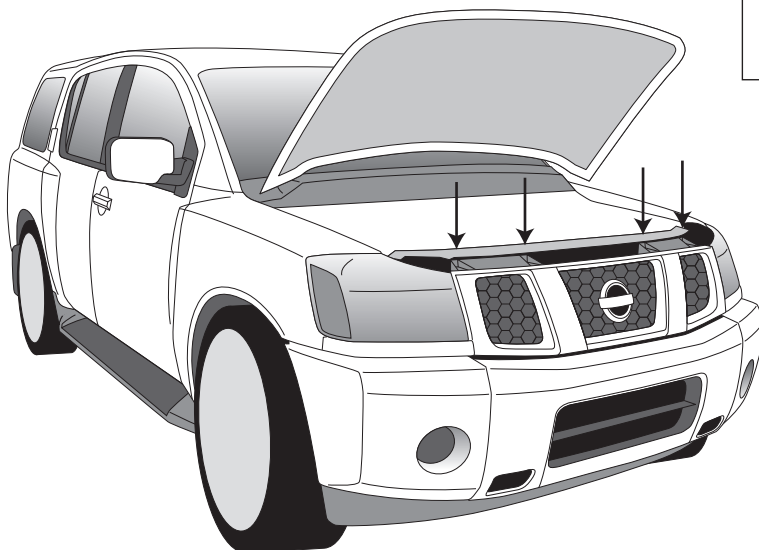
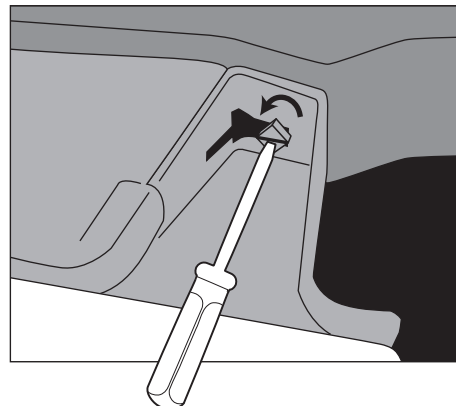

1

Once the top four retainer clips are released, squeeze each of the side clips and pull gently to free the top of the grille.

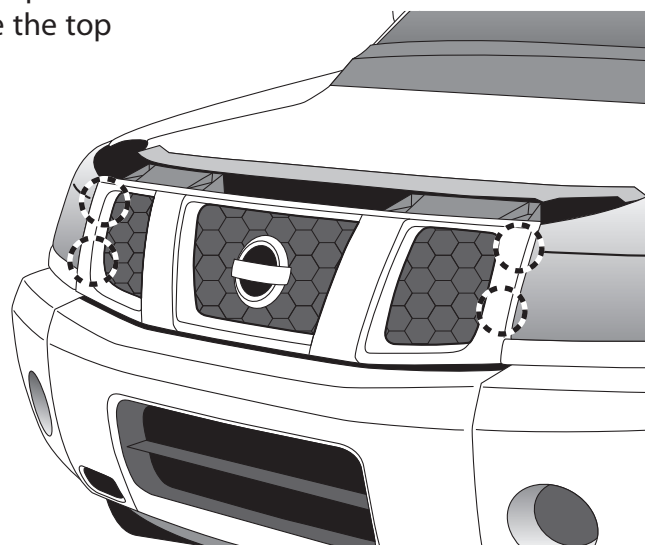
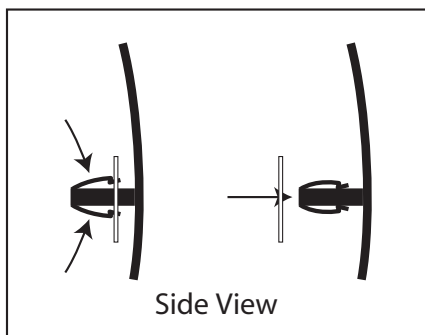

2

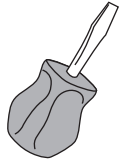

Note: Because of the tight fit, you will need a short flat head screwdriver for this step.

Using a short flat head screwdriver, release the three plastic retainer clips on the bottom of the grille shell by reaching up through the bumper grille opening. To release the clips, turn each of the clips 45 degrees, just like the top four clips in Step 1.

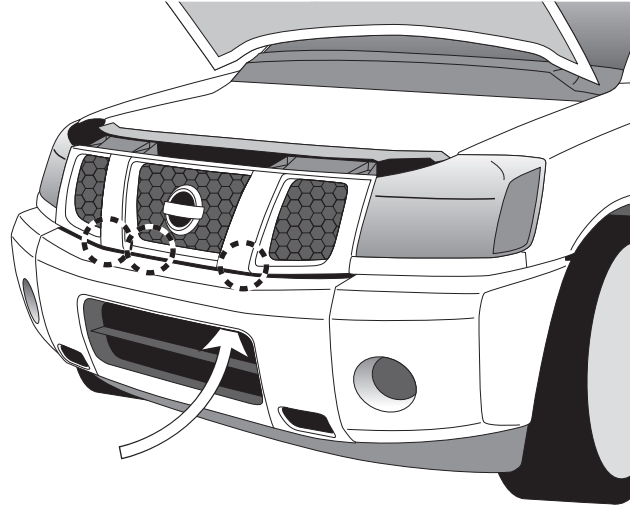

3

Once the grille shell has been removed, go back to the vehicle and remove the seven retainer clips from the body of the vehicle and replace them in the grille. Carefully set the grille shell aside.

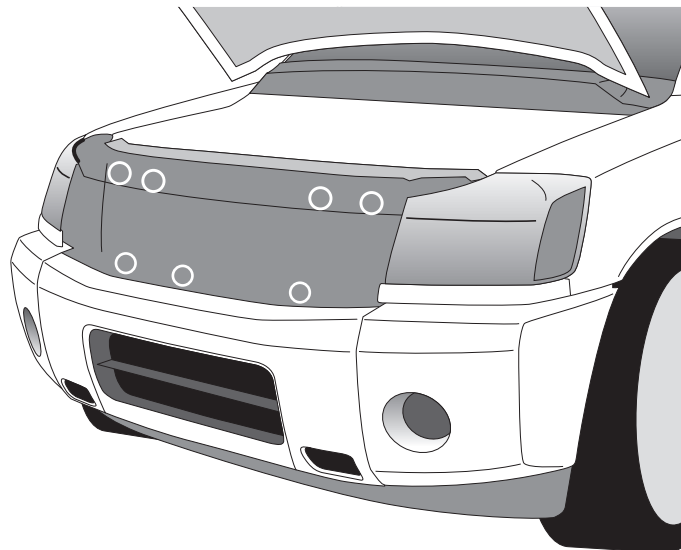
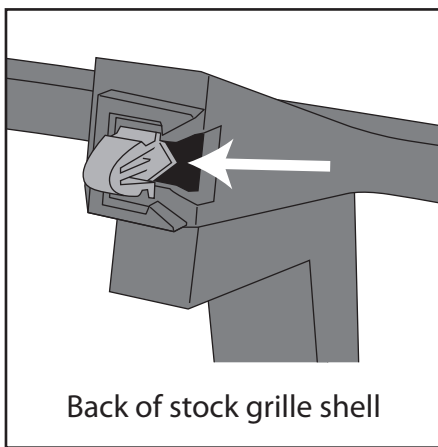

4

Insert a Billet Grille into each opening and secure by sliding a slider tab through each of the mounting tabs. Secure each of the slider tabs by inserting a hair pin clip through the hole in the slider tab.

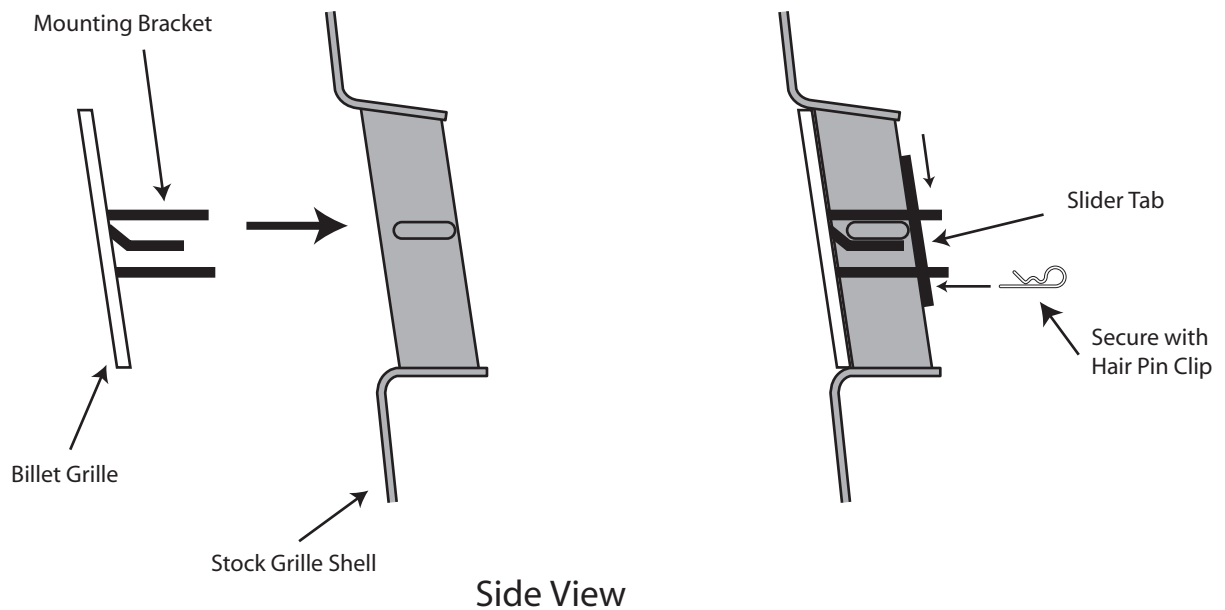

5

Once the new Billet Grille is in place and secured, reinstall the stock grille shell back on the vehicle. Make sure that all the plastic retainer clips are secure - four on top, three on the bottom, and two on each side - and close the hood. Enjoy your award-winning product you have just installed!

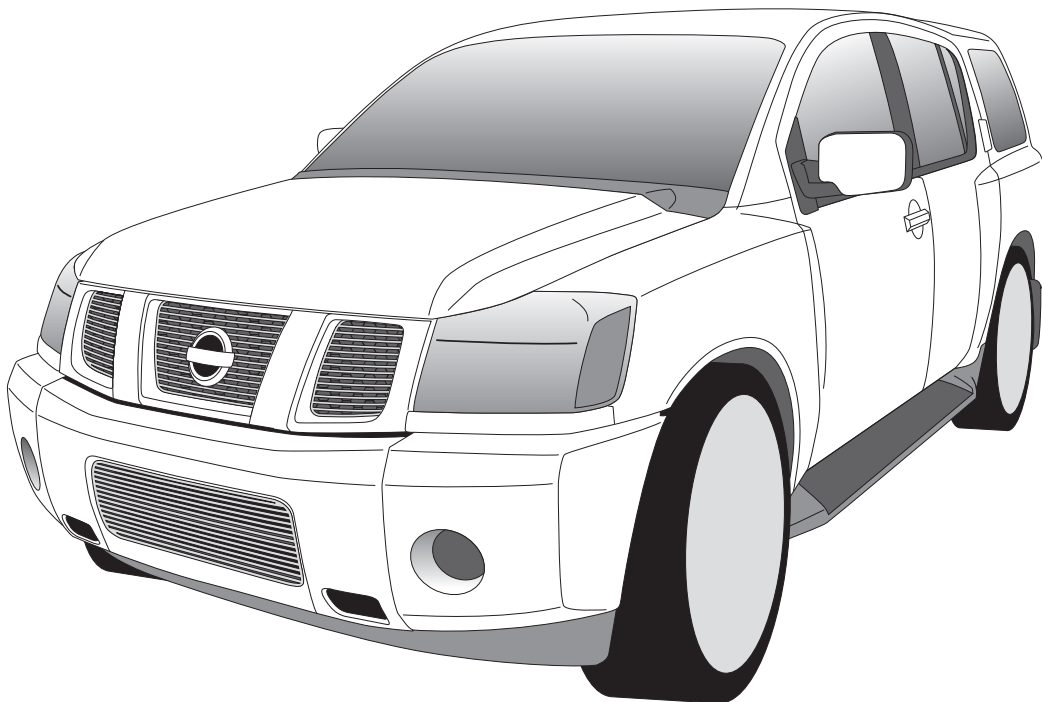

6

Care and Cleaning

To keep your billet inserts looking their best, we recommend using only mild soap and water and a soft cotton cloth to wash and dry it. Use of rough cleaning agents or cloths may scratch or dull your billet inserts.

Should your billet inserts become scratched or dull, we recommend TRENZ® Metal Polish to bring back the mirror finish. There are three grades of TRENZ® Metal Polish (Coarse, Medium and Fine) that will help you keep your billet inserts looking brand new. Select the TRENZ® Metal Polishes best for your needs:

1. Course (Red) Polish – For severe scratches and pitted problems.
2. Medium (Green) Polish – For light scratches and dulling problems.
3. Fine (White) Polish – To bring back the mirror finish.

TRENZ® Metal Polish can be used on all metal products, including aluminum, stainless steel, brass and copper. If you have additional questions or concerns on the maintenance of your Lund® billet inserts, please call us at 800-328-5863. You may also use high quality commercially available polish recommended for aluminum accessories.

Congratulations!

You have purchased one of many quality Lund® branded products offered by Lund International, Inc. We take the utmost pride in our products and want you to enjoy years of satisfaction from your investment. We have made every effort to ensure that your product is top quality in terms of fit, durability, finish and ease of installation.



Lund International, Lund Accessories Division
775 Tipton Industrial Drive, Building 2, Suite F
Lawrenceville, GA 30045

Phone 800-328-5863 • Fax 800-782-5448 • Visit us at lundinternational.com

© 2005 Lund International, Inc. All rights reserved.
Lund® and the Lund® logo are trademarks of Lund International, Inc.

