



Interceptor™ - Interceptor II™ - Avenger™

For proper installation and best possible fit, please read all instructions **BEFORE** you begin.
For technical assistance or to obtain missing parts, please call Customer Relations at 1-800-328-5863.

Important Safety Information



- CAUTION - Before driving, ensure that the hood shield is properly secured to vehicle.
- Do not use automatic "brush-style" car washes.
- Do not use cleaning solvents of any kind.
- Periodically check all components for tightness.

Contents **NOTE:** Actual product may vary from illustration.

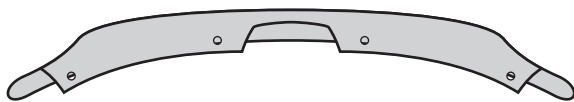

Hood Shield

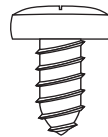

Phillips Screw x4

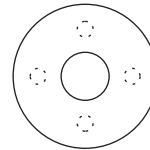

Plastic Washer x4

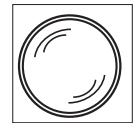

Bump On x4

Tools Required



Car Wash Supplies



Clean Towel

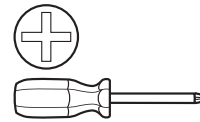

Phillips Screwdriver

Preparation Before Painting / Installation

- A trial fit is recommended to ensure proper positioning and fit.
- Check fit of parts before painting as we will not accept the return of modified or painted parts.
- Wash and dry your vehicle to remove any debris and/or dirt from the installation area.

Installation Steps **NOTE:** Actual application may vary slightly from illustrations.

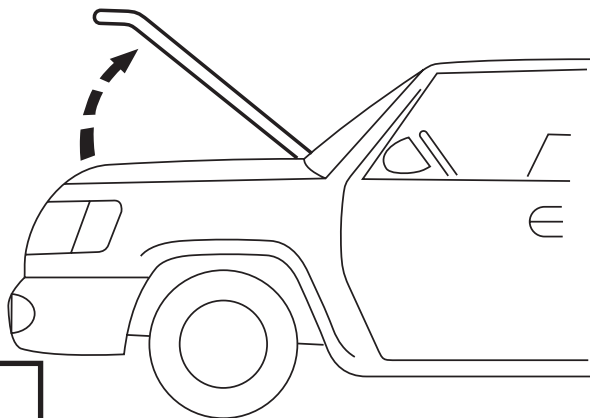

1

Align Hood Shield with holes in hood.

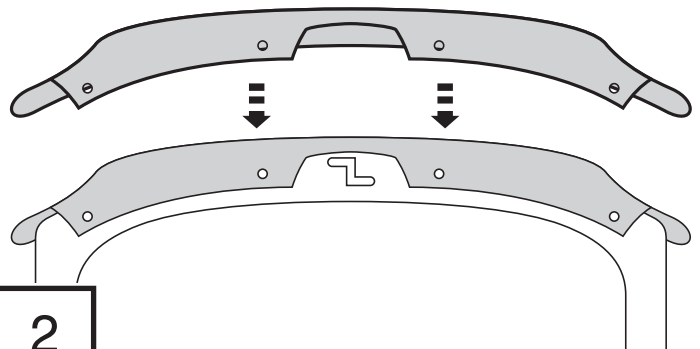

2

Installation Steps

NOTE: Actual application may vary slightly from drawings.

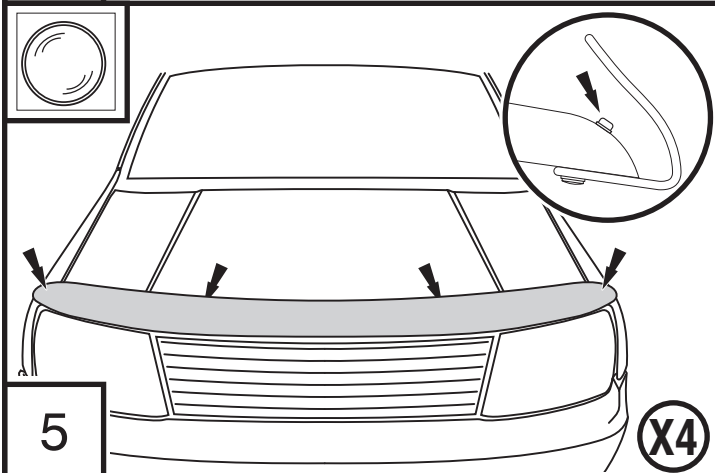
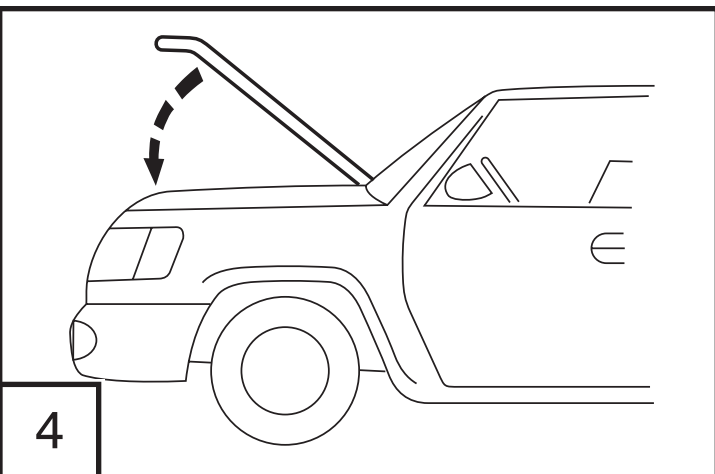
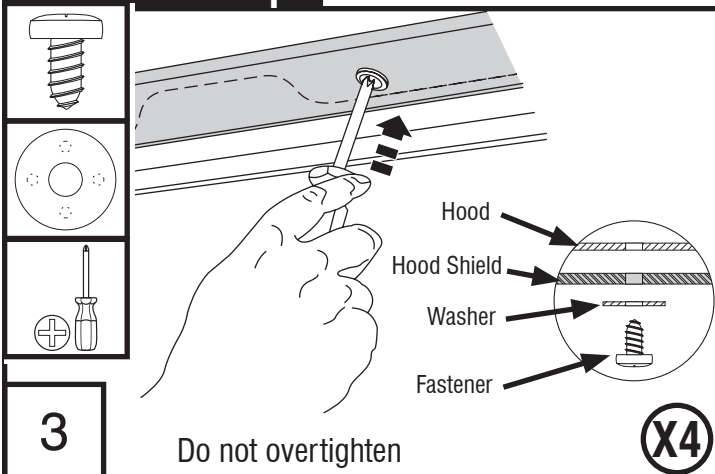

Care and Cleaning

- Wash only with mild soap & dry with a clean cloth.

Congratulations!

You have purchased one of the many quality Lund® branded products offered by Lund International, Inc. We take the utmost pride in our products and want you to enjoy years of satisfaction from your investment. We have made every effort to ensure that your product is top quality in terms of fit, durability, finish and ease of installation.



Lund International, Lund Accessories Division
300 Horizon Drive, Suwanee, GA 30024
800-328-5863 • Visit us at lundinternational.com



© 2007 Lund International, Inc. All rights reserved.
Lund® and the Lund® logo are trademarks of Lund International, Inc.





Interceptor™ - Interceptor II™ - Avenger™

Pour obtenir une installation correcte et le meilleur ajustement possible, lire toutes les instructions AVANT de commencer. Pour toute assistance technique ou obtention de pièces manquantes, appeler le service des relations avec la clientèle au 1-800-328-5863

Informations importantes concernant la sécurité



- ATTENTION – Avant de conduire, s'assurer que le pare-insectes est solidement assujettie sur le véhicule.
- Ne pas utiliser les stations de lavage de voitures à brosse.
- Ne pas utiliser de solvants.
- Vérifier régulièrement le serrage des composants.

Contenu **NOTE:** Le produit réel peut changer de l'illustration.

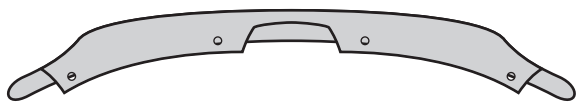

Pare-insectes

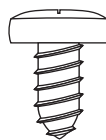

Vis Phillips
(4)

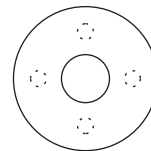

Rondelle En plastique
(4)



Butoirs (4)

Outils nécessaires



Fournitures pour lavage de
voiture



Serviette propre

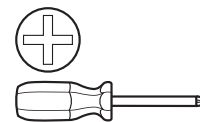

Tournevis Phillips

Préparation pour la peinture/l'installation

- Il est recommandé de procéder à un essai pour s'assurer que le positionnement et l'ajustement sont corrects.
- Vérifier l'ajustement des pièces avant peinture, car nous n'acceptons pas le retour de pièces modifiées ou peintes.
- Laver les glissières de glaces de la portière du véhicule pour éliminer toute poussière et tous débris.
- Sécher les glissières avec une serviette propre.

Étapes d'installation

REMARQUE : La méthode d'application peut être légèrement différente de celle représentée par les illustrations.

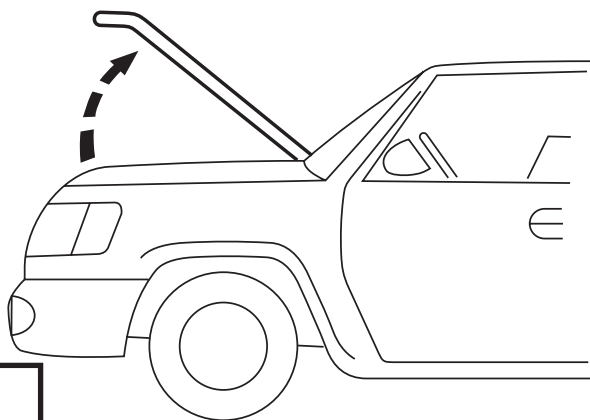

1

Alignez Pare-insectes
avec des trous dans le capot.

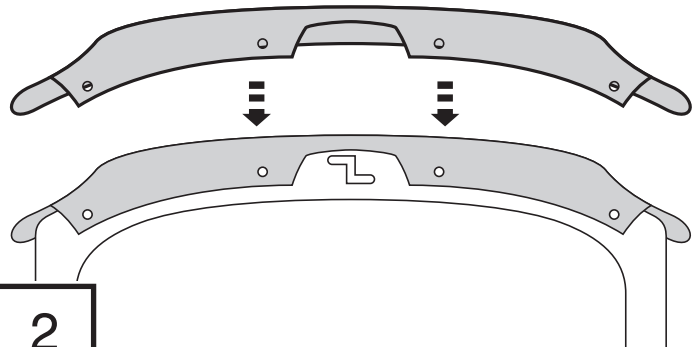

2

Étapes d'installation

REMARQUE : La méthode d'application peut être légèrement différente de celle représentée par les illustrations.

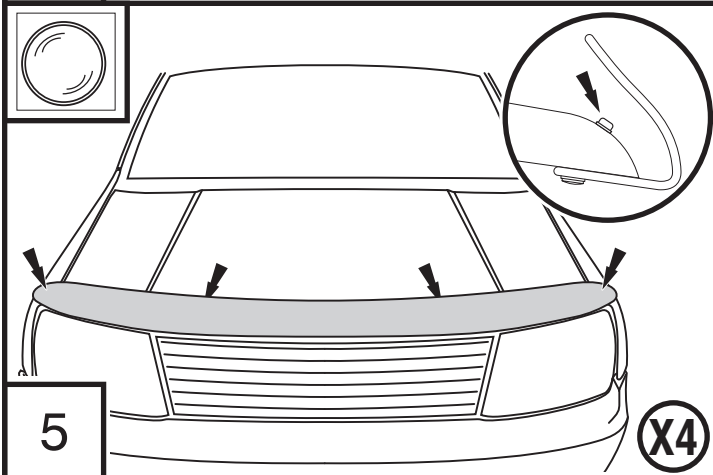
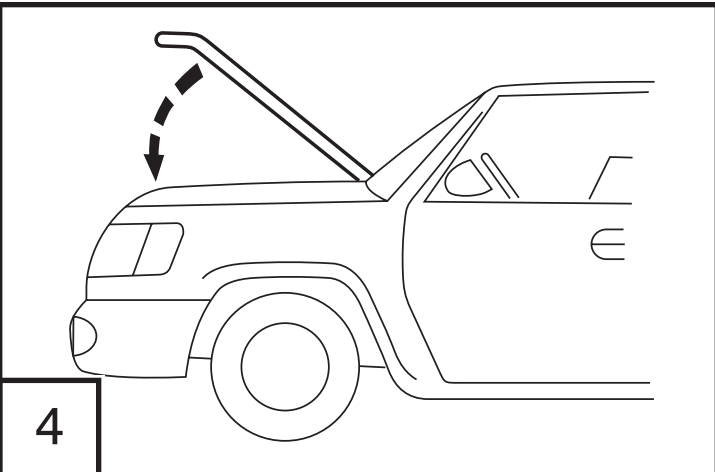
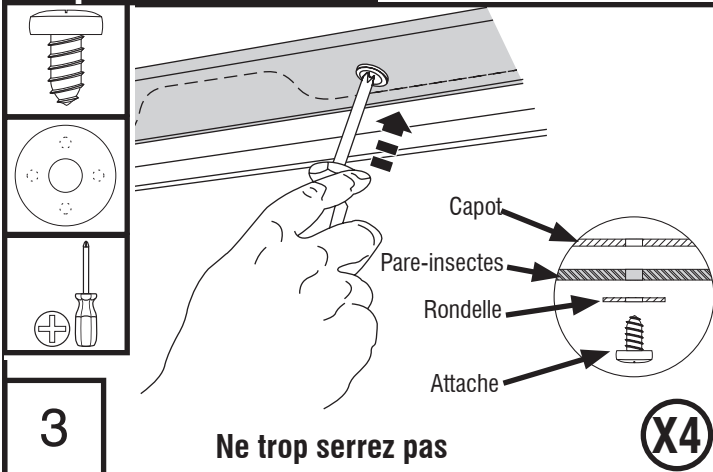

Entretien et nettoyage

- Laver exclusivement avec de l'eau savonneuse et sécher avec un chiffon propre.

Félicitations !

Vous avez acheté l'un des nombreux produits de qualité Lund® fabriqués par Lund International, Inc. Nous sommes extrêmement fiers de nos produits et souhaitons que vous tiriez des années de satisfaction de votre investissement. Nous avons pris toutes les mesures nécessaires pour assurer que ce produit est d'une qualité supérieure en ce qui concerne l'ajustement, la durabilité, la finition et la facilité d'installation.



Lund International, Lund Accessories Division
300 Horizon Drive, Suwanee, GA 30024
800-328-5863 • Visitez notre site lundinternational.com



© 2007 Lund International, Inc. Tous droits réservés.
Lund™, et le logo Lund™ sont des marques déposées de Lund International, Inc.





Interceptor™ - Interceptor II™ - Avenger™

Para una instalación adecuada y el mejor ajuste posible, lea todas las instrucciones ANTES de comenzar. Si desea recibir asistencia técnica u obtener piezas faltantes, llame al Servicio al cliente al 1-800-328-5863.

Información importante de seguridad



- PRECAUCIÓN - Antes de conducir, asegúrese de que la visera deflectora esté correctamente anclada al vehículo.
- No utilice servicios automáticos de limpieza de vehículos que utilizan cepillos.
- No utilice limpiadores al solvente de ningún tipo.
- Compruebe periódicamente que todos los componentes estén ajustados.

Contenido **NOTA:** El producto real puede variar de la ilustración.



Cubierta para capó

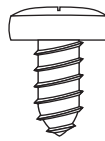

Tornillo Phillips (4)

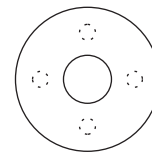

Arandela Plástica (4)



Soporte x4

Herramientas necesarias



Equipo de limpieza de vehículos

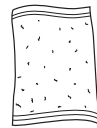

Toalla limpia

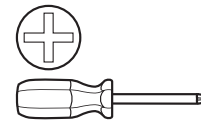

Destornillador Phillips

Preparación antes de pintar o instalar

- Se recomienda realizar un ajuste de prueba para asegurar el posicionamiento y ajuste correctos.
- Compruebe que las piezas se ajusten correctamente antes de pintarlas, ya que no aceptaremos la devolución de piezas modificadas o pintadas.
- Lave los canales de la ventanilla del vehículo para quitar los desechos y la suciedad.
- Seque los canales de la ventanilla con una toalla limpia.

Pasos de instalación **NOTA:** El uso real puede variar levemente de ilustraciones.

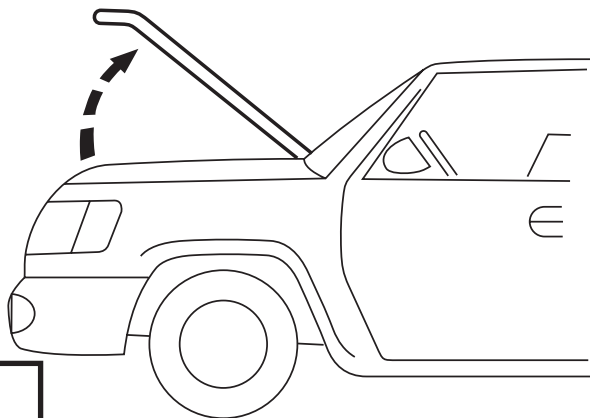

1

Alinee Cubierta para capó con los agujeros en capilla.

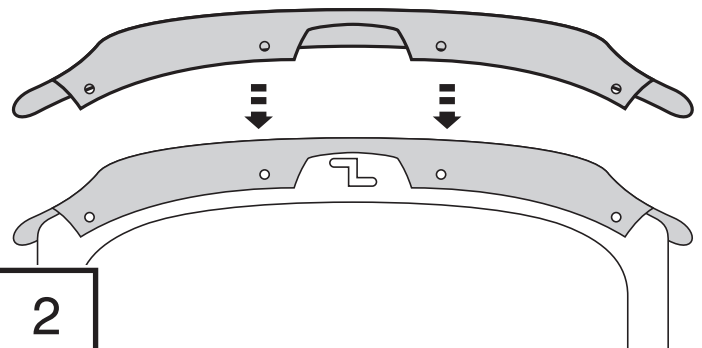

2

Pasos de instalación

NOTA: El uso real puede variar levemente de ilustraciones.

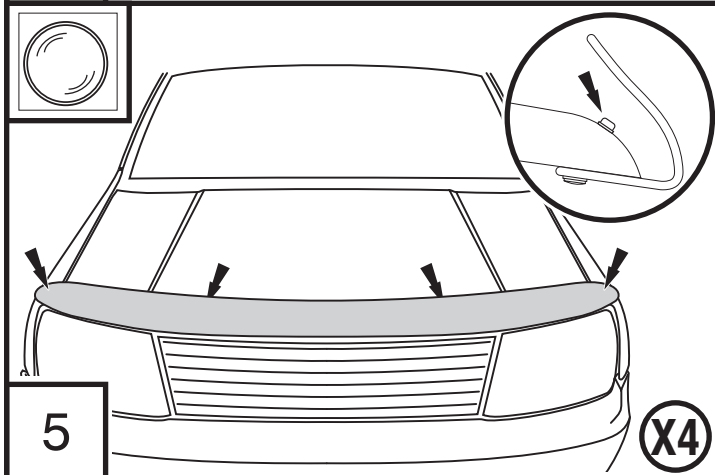
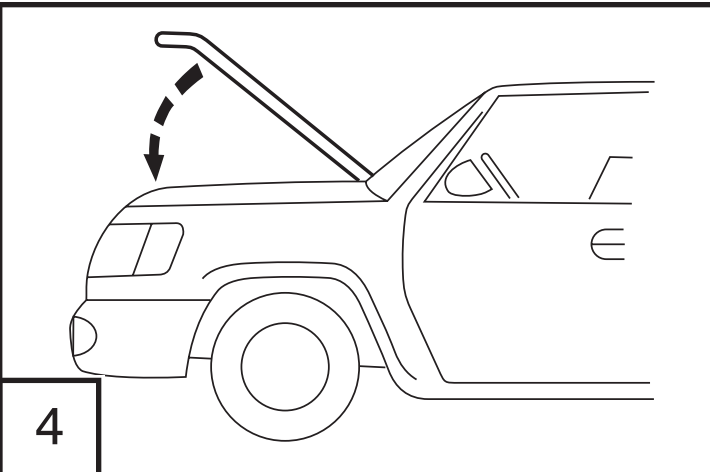
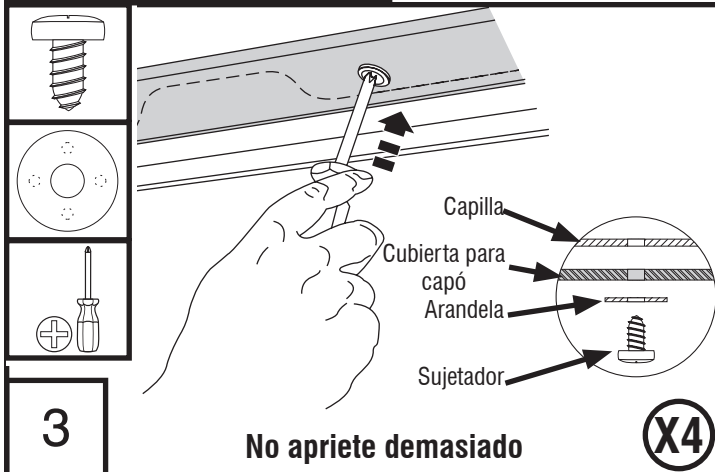

Cuidado y limpieza

- Limpie solamente con agua jabonosa tibia y seque con un paño limpio.

Felicidades

Usted ha comprado uno de los tantos artículos de calidad de Lund® ofrecidos por Lund International, Inc. Nuestros productos son nuestro mayor orgullo. Deseamos que disfrute de años de satisfacción con su inversión. Hemos realizado todos los esfuerzos para asegurarnos de que su producto sea de la mejor calidad en cuanto a ajuste, durabilidad, acabado y facilidad de instalación.



Lund International, Lund Accessories Division
300 Horizon Drive, Suwanee, GA 30024
800-328-5863 • Visite nuestro sitio Web: lundinternational.com



© 2007 Lund International, Inc. Todos los derechos reservados.
Lund™, el logo y el logo de Lund™ son marcas comerciales de Lund International, Inc.

