



## INSTALLATION INSTRUCTIONS FOR PART 95-73365

### **APPLICATIONS** **HYUNDAI GENESIS COUPE** **2010** **(WITH AUTO CLIMATE CONTROLS)**

# 95-73365

#### KIT FEATURES

- DDIN Head Unit Provision
- ISO Stacked Head Unit Provision
- Painted Silver to match factory finish



#### KIT COMPONENTS

A) Trim Panel B) Double DIN Brackets C) (6) PC-7503 Panel Clips

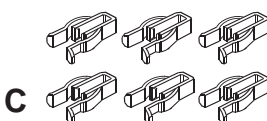
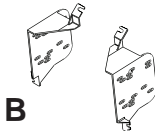
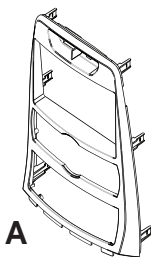

#### WIRING AND ANTENNA CONNECTIONS (Sold Separately)

##### Wiring Harness:

- 70-7303 - Kia/Hyundai Harness 2009 - up

##### Antenna Adapter:

- 40-K111 - Kia/Hyundai Antenna Adapter 2007-up

#### TOOLS REQUIRED:

- Small Flat Blade Screwdriver
- Phillips Screwdriver
- Panel Removal Tool
- Socket Wrench

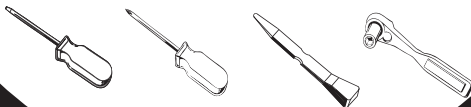

METRA. THE WORLD'S BEST KITS.™



1-800-221-0932



www.metraonline.com

© COPYRIGHT 2007-2009 METRA ELECTRONICS CORPORATION



**TABLE OF CONTENTS**

**Dash Disassembly**

**- Hyundai Genesis Coupe 2010 ..... 1**

**Kit Preparation**

**- Hyundai Genesis Coupe 2010 ..... 2**

**Kit Assembly**

**- Double DIN / Stacked ISO DIN Head Unit Provision. .... 3**

**\*Note:**

**Refer also to the instructions included with the aftermarket radio.**



**KNOWLEDGE IS POWER**

Enhance your installation and fabrication skills by enrolling in the most recognized and respected mobile electronics school in our industry. Log onto [www.installerinstitute.com](http://www.installerinstitute.com) or call 800-354-6782 for more information and take steps toward a better tomorrow.



Metra recommends MECP certified technicians.

**HYUNDAI GENESIS COUPE 2010**

- 1** Disconnect the negative battery terminal to prevent an accidental short circuit.
- 2** Unclip and remove the shifter trim panel. (Figure A)
- 3** Unclip and remove the radio/climate control trim panel. (Figure B)
- 4** Unclip and remove the display trim panel above radio. (Figure C)
- 5** Remove (4) Phillips screws securing the radio.
- 6** Remove (4) Phillips screws securing the climate control to the factory trim panel.

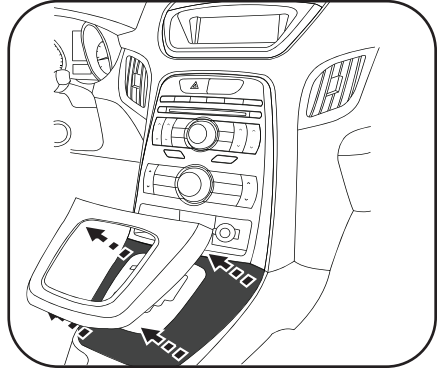
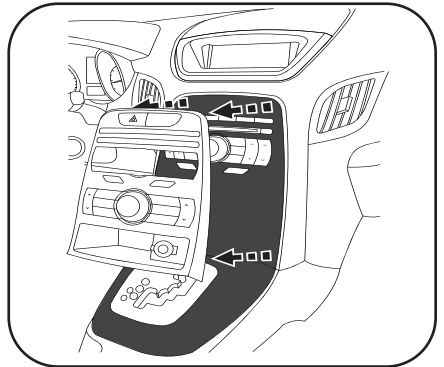
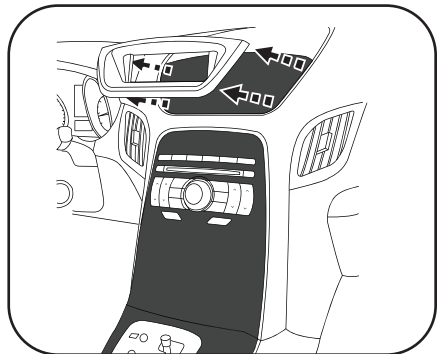
**A****B****C**



**KIT PREPARATION**

**HYUNDAI GENESIS COUPE 2010**

- 1** Attach the climate control to the 95-7336S trim plate using the factory hardware. (Figure A)
- 2** Attach the (6) panel clips to the 95-7336S trim plate. (Figure B)

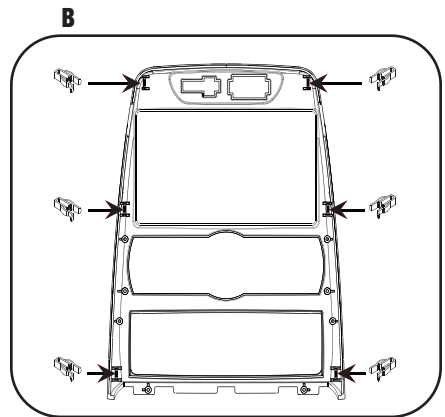
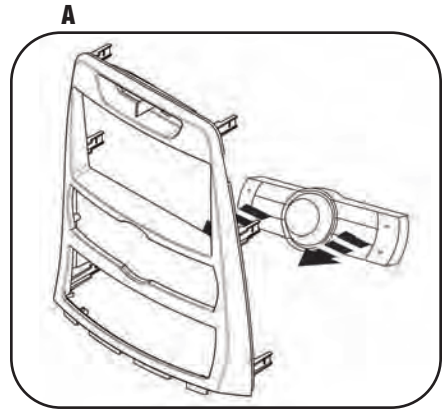

*Continue to kit assembly*

**HYUNDAI GENESIS COUPE 2010****DOUBLE DIN / STACKED ISO DIN HEAD UNIT  
PROVISIONS**

- 1** Locate the factory wiring harness in the dash. Metra recommends using the proper mating adapter from Metra or AXCESS. Re-connect the negative battery terminal and test the unit for proper operation.
- 2** Attach the Double DIN brackets to the aftermarket radio then mount the unit in the sub dash. (Figure A)
- 3** Reassemble dash in reverse order of disassembly using the 95-7336S trim panel instead of the factory trim panel.

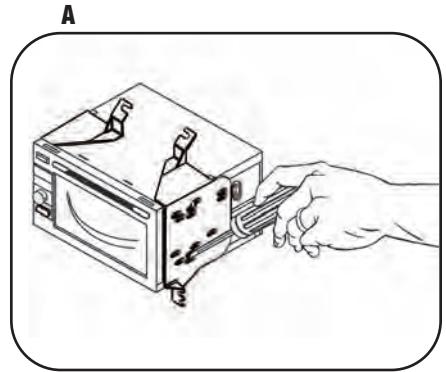



**NOTES**

---

---

---

---

---

---

---

---

---

---



# 95-7336S INSTRUCTIONS

METRA. THE WORLD'S BEST KITS.™



1-800-221-0932



[www.metraonline.com](http://www.metraonline.com)

REV. 12/14/09 © COPYRIGHT 2003-2009 METRA ELECTRONICS CORPORATION INST95-7336S