



INSTALLATION INSTRUCTIONS FOR PART 95-7801

APPLICATIONS **See Application List Inside**

95-7801



KIT FEATURES

- Double DIN Radio Provision
- Stacked ISO Units Provision

KIT COMPONENTS

- A) Radio Housing • B) Rear Support Tray • C) ISO Brackets
- D) Mounting Bracket (Acura Legend) • E) (2) #8 x 1/2" Phillips Pan Head Screws
- F) (6) #6 x 1/4" Phillips Flat Head Screws

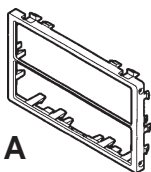

A

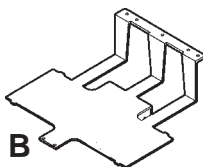

B

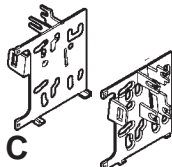

C



D



E



F

TOOLS REQUIRED:

- Phillips Screwdriver • Cutting Tool



1-800-221-0932



www.metraonline.com

© COPYRIGHT 2001-2008 METRA ELECTRONICS CORPORATION

TABLE OF CONTENTS

Dash Disassembly / Kit Preparation

- ACURA

- CL 1997-99	1
- Integra 1990-93	1
- Integra 1994-01	2
- Legend 1990-96	2
- TL 1996-98	3
- Vigor 1992-94	3

- HONDA

- Accord 1990-93	4
- Accord 1994-97	4
- Accord 1998-02	5
- Civic 1999-00	5
- CRV 1997-01	6
- CRV 2002-06	6
- Odyssey 1995-99	7
- Odyssey 1999-04	7
- Prelude 1992-96	8
- Prelude 1997-01	8

- ISUZU

- Oasis 1996-99	7
------------------------------	----------

Kit Assembly

- Kit Assembly Preparation	9
- DIN Radio with Pocket Provision	10
- ISO Mount Radio with Pocket Provision	10
<u>Final Assembly</u>	11

***Note:**

Refer also to the instructions included with the aftermarket radio.

ACURA CL 1997-1999

- 1 Disconnect the negative battery terminal to prevent an accidental short circuit.
- 2 Unclip the radio trim bezel and disconnect the clock and climate control wiring. Remove (2) 8mm hex-head screws securing the factory head unit and disconnect the wiring. (Fig. A)
- 3 Cut and remove all mounting clips on the **Radio Housing** EXCEPT clips "A" and "H". (Fig. B)
Skip to step #3b on Page 10.

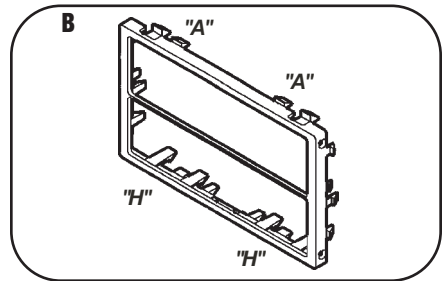
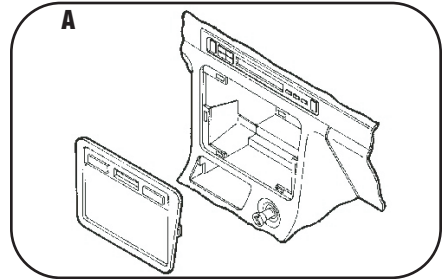

ACURA INTEGRA 1990-1993

- 1 Disconnect the negative battery terminal to prevent an accidental short circuit.
- 2 Remove (3) screws from each side of the center console and remove the console. Remove (2) screws securing the factory head unit to the sub-dash support bracket. Slide the head unit/pocket assembly out and disconnect the wiring. (Fig. A)
- 3 Cut and remove the mounting tabs from the bottom of the **Rear Support Tray** (Fig. A). Cut and remove all mounting clips on the **Radio Housing** EXCEPT clips "C" and "H" (Fig. B).
Skip to step #3b on Page 10.

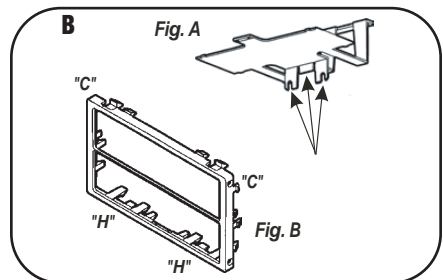
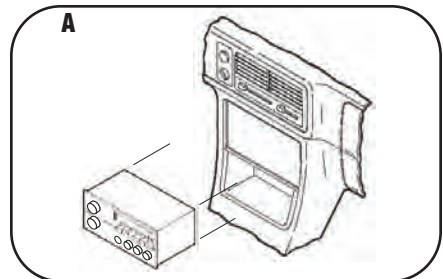

ACURA INTEGRA 1994-2001

- 1 Disconnect the negative battery terminal to prevent an accidental short circuit.
- 2 Remove the cover cap located under the emergency brake and remove (2) screws exposed. Remove (2) screws from the rear corners of the lower dash trim bezel and remove. Remove the ashtray and (2) screws exposed. Unsnap the ashtray housing and disconnect the cigarette lighter harness. Remove the gear shifter knob and unsnap the shifter trim. Remove (2) screws below the radio opening and remove the upper dash trim bezel. Remove (2) 8mm screws securing the factory head unit and disconnect the wiring. (Fig. A)
- 3 Cut and remove all mounting clips on the **Radio Housing** EXCEPT clips "C" and "H" (Fig. A). Cut and remove the slots on the bottom of the **ISO Brackets** (Fig. B). (**THE REAR SUPPORT TRAY WILL NOT BE USED**). (Fig. B)
Skip to step #3b on Page 10.

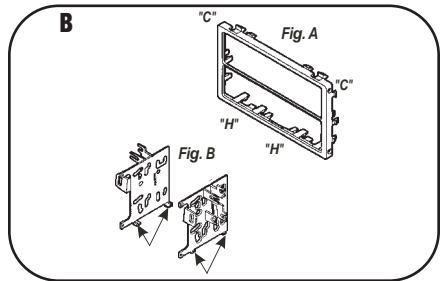
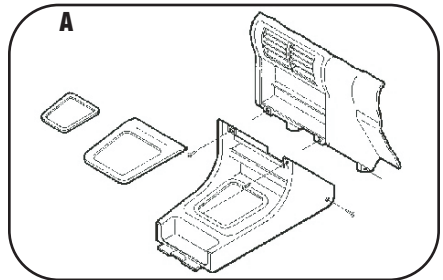

ACURA LEGEND 1990-1996

- 1 Disconnect the negative battery terminal to prevent an accidental short circuit.
- 2 Remove (2) screws below the ashtray. Unclip the dash trim bezel. Disconnect the cigarette lighter wiring and remove the bezel. Remove (2) bolts securing the rear of the factory head unit and disconnect the wiring. (Fig. A)
- 3 Attach the **Mounting Bracket** to the bottom of the **Rear Support Tray** (Fig. A). Cut and remove all mounting clips on the **Radio Housing** EXCEPT clips "E" and "J". (Fig. B)
Skip to step #3b on Page 10.

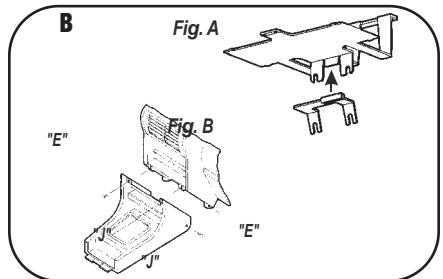
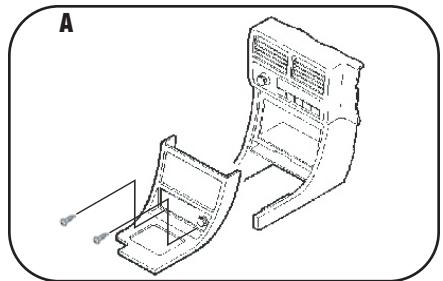

ACURA TL 1996-1998

- 1 Disconnect the negative battery terminal to prevent an accidental short circuit.
- 2 Using a small screwdriver, unclip the perimeter of the radio trim bezel. Disconnect the climate control and rear defroster wiring and remove the bezel. Remove (4) Phillips screws securing the factory head unit/trim bezel assembly. Loosen (2) Phillips screws securing the back of the head unit to the metal housing and slide the unit out. (It is NOT necessary to remove the screws securing the metal housing to the bezel). Disconnect the wiring. (Fig. A)
- 3 Cut and remove the mounting tabs (Fig. B) from the bottom of the **Rear Support Tray** (Fig. A). Cut and remove all mounting clips on the **Radio Housing** EXCEPT clips "B" and "K" (Fig. B). Cut and remove the slots on the bottom of the **ISO Brackets** (Fig. C).
Skip to step #3b on Page 10.

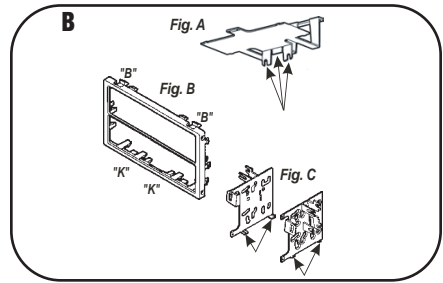
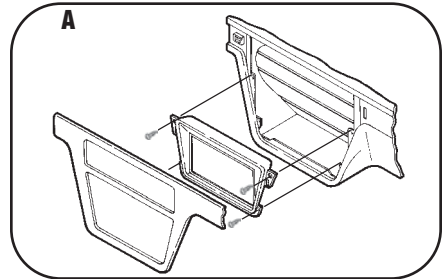

ACURA VIGOR 1992-1994

- 1 Disconnect the negative battery terminal to prevent an accidental short circuit.
- 2 Remove the access cap from the climate control cluster and (1) screw exposed. Unclip the cluster and remove (2) screws exposed. Remove the ashtray and (2) Phillips screws exposed. Remove the cover caps from each front corner of the center console and the screws exposed. Open the storage compartment, lift up the carpet and remove (2) screws exposed. Lift up on the center console and remove. Unclip the radio trim bezel and disconnect the wiring. Remove (2) bolts from the back of the factory head unit and disconnect the wiring. (Fig. A)
- 3 Cut and remove the mounting tabs from the bottom of the **Rear Support Tray** (Fig. A). Cut and remove all mounting clips on the **Radio Housing** EXCEPT clips "A" and "H" (Fig. B).
Skip to step #3b on Page 10.

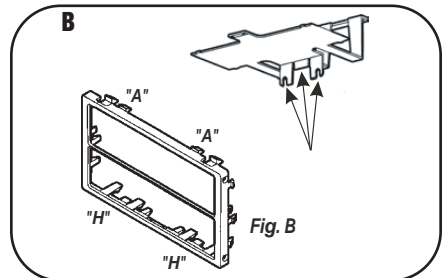
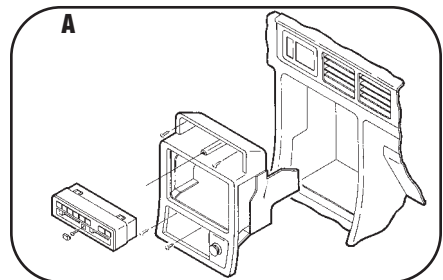

HONDA ACCORD 1990-1993

- 1 Disconnect the negative battery terminal to prevent an accidental short circuit.
- 2 Remove (4) screws from the lower portion of the center console. Remove the gear shifter knob and lift the console out. Remove the ashtray and ashtray bracket. Remove (2) screws from the bottom of the head unit support, slide the unit out and disconnect the wiring. (Fig. A)
- 3 Cut and remove all mounting clips on the **Radio Housing** EXCEPT clips "C" and "H" (Fig. A). Cut and remove the slots on the bottom of the **ISO Brackets** (Fig. B). (**THE REAR SUPPORT TRAY WILL NOT BE USED**).
(Fig. B) Skip to step #3b on Page 10.

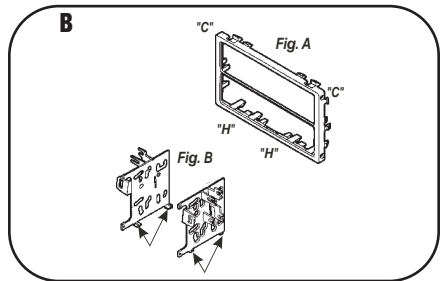
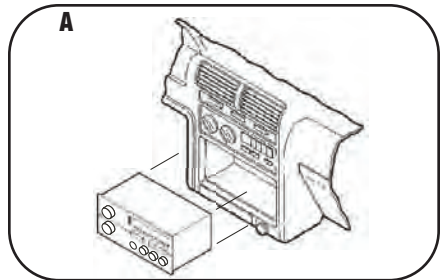

HONDA ACCORD 1994-1997

- 1 Disconnect the negative battery terminal to prevent an accidental short circuit.
- 2 Remove the ashtray and (1) 3/4" #8 Phillips screw exposed. Open the storage compartment and remove (2) #8 Phillips screws exposed. Remove the cupholder tray and (3) #8 Phillips screws inside. Lift the center console out and remove (2) Phillips screws exposed at the base of the dash trim bezel. Unclip the bezel and remove. Remove (2) hex-head screws securing the factory head unit and disconnect the wiring. (Fig. A)
- 3 Cut and remove all mounting clips on the **Radio Housing** EXCEPT clips "A" and "H". (Fig. B) Skip to step #3b on Page 10.

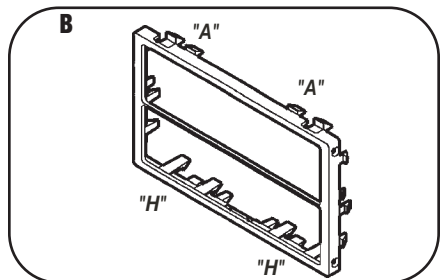
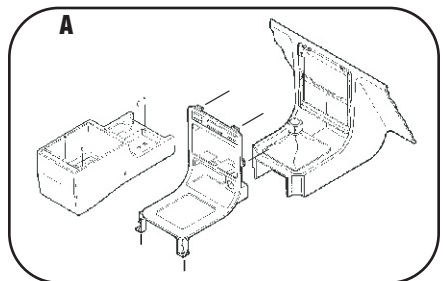

HONDA ACCORD 1998-2002

- 1 Disconnect the negative battery terminal to prevent an accidental short circuit.
- 2 Unsnap the clock panel, disconnect the wiring and remove. Remove (1) Phillips screw exposed in the clock cavity. Remove (2) Phillips screws below the factory head unit. Unclip the radio trim bezel and disconnect the wiring. Remove (4) Phillips screws securing the factory head unit assembly and disconnect the wiring. Remove (2) screws securing the factory pocket to the assembly. (Fig. A)
- 3 Cut and remove the mounting tabs from the bottom of the **Rear Support Tray** (Fig. A). Cut and remove the slots on the bottom of the **ISO Brackets** (Fig. B). Locate tabs "A" on the ISO Brackets for mounting, cut and remove tabs "B" (Fig. C). Cut and remove all mounting clips on the **Radio Housing**. (Fig. B) Skip to step #3b on Page 10.

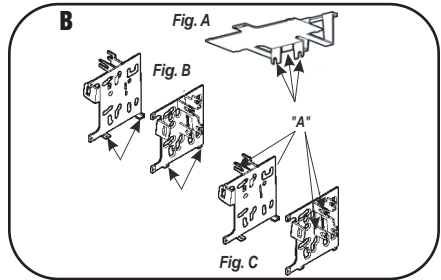
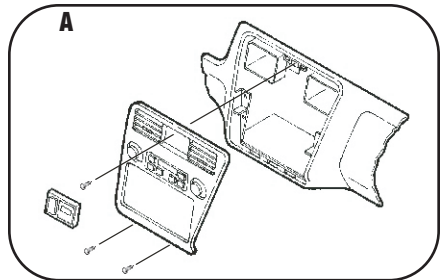

HONDA CIVIC 1999-2000

- 1 Disconnect the negative battery terminal to prevent an accidental short circuit.
- 2 Remove (2) Phillips screws from the bottom edge of the glove box door and remove the door. Remove (3) Phillips screws from the lower steering column panel. Pull straight down on the lower steering column panel and remove the panel. Remove (2) Phillips screws under the climate controls. Remove (4) Phillips screws from the lower dash location. Remove (4) Phillips screws securing the bottom of the dash trim bezel/head unit assembly and pull the assembly out as far as possible. Cut the zip ties securing the head unit and climate control wires, slide dash trim bezel/head unit assembly from the dash cavity and disconnect the wiring. (Fig. A)
- 3 Cut and remove all mounting clips on the **Radio Housing** EXCEPT clips "B" and "H". (Fig. B) Skip to step #3a on Page 9.

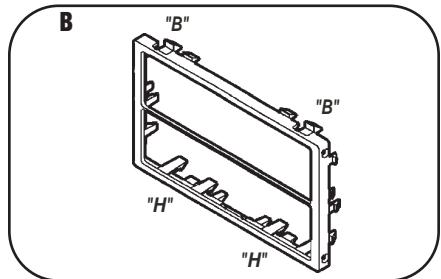
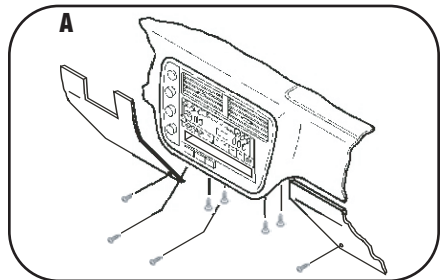

HONDA CRV 1997-2001

- 1 Disconnect the negative battery terminal to prevent an accidental short circuit.
- 2 Open the glove box, squeeze the retaining clips and remove the stoppers. Lower the glove box and remove (2) Phillips screws from the left edge. Remove (2) Phillips screws from the lower steering column panel and remove. Unclip the lower console cover (below the ashtray and pocket) and remove. Remove (2) Phillips screws from the base of the center console, open the console pocket and remove the (4) outer screws exposed. Unclip the center console and remove. Remove (2) Phillips screws securing the radio trim bezel, disconnect the wiring, and remove the trim bezel/head unit assembly. Remove (4) Phillips screws securing the head unit to the bezel and remove. (Fig. A)
- 3 Cut and remove all mounting clips on the **Radio Housing** EXCEPT clips "B" and "H" (Fig. A). Cut and remove the slots on the bottom of the **ISO Brackets** (Fig. B). Skip to step #3a on Page 9.

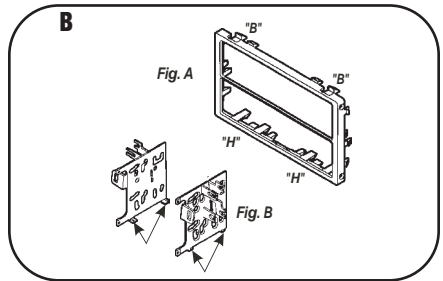
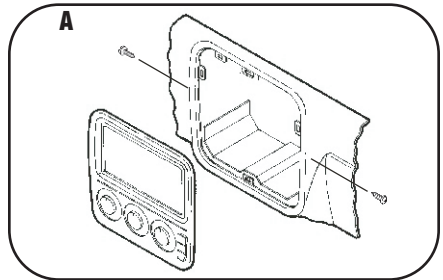

HONDA CRV 2002-2006

- 1 Disconnect the negative battery terminal to prevent an accidental short circuit.
- 2 Remove (2) Phillips from the bottom edge of the radio trim bezel. Unclip the trim bezel and remove. Remove (4) Phillips screws securing the factory head unit and disconnect the wiring. (Fig. A)
- 3 Cut and remove all mounting clips on the **Radio Housing** EXCEPT clips "C" and "H". (Fig. B) Skip to step #3a on Page 9.

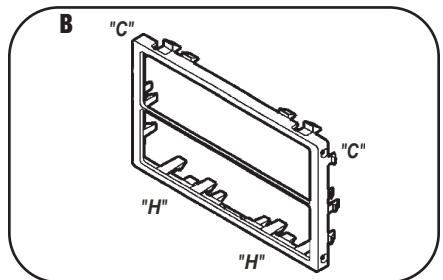
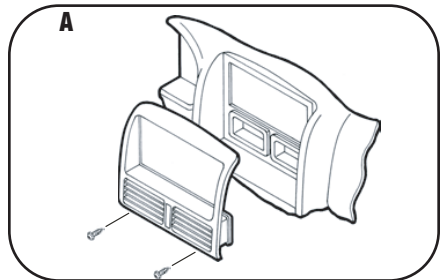

HONDA ODYSSEY 1995-1998

ISUZU OASIS 1996-1999

- 1 Disconnect the negative battery terminal to prevent an accidental short circuit.
- 2 Lower the glove box assembly. Remove (2) Phillips screws exposed on the right side of the underdash. Remove (2) Phillips screws from the driver's side knee bolster and (1) Phillips screw in the coin pocket. Remove (5) Phillips screws from the underdash panel and remove the panel. Remove (4) Phillips screws from the cupholder assembly and remove. Remove (2) Phillips screws securing the factory head unit and disconnect the wiring. (Fig. A)
- 3 Cut and remove all mounting clips on the **Radio Housing EXCEPT** clips "D" and "H" (Fig. A). Cut and remove the slots on the bottom of the **ISO Brackets** (Fig. B). (**THE REAR SUPPORT TRAY WILL NOT BE USED**). (Fig. B) Skip to step #3b on Page 10.

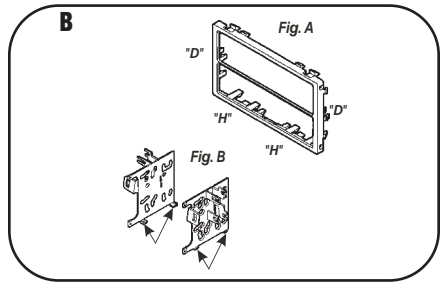
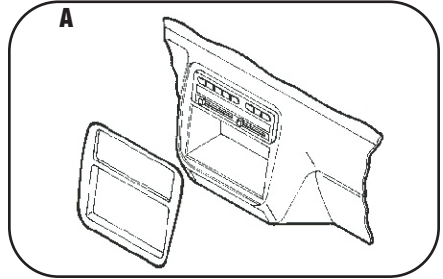

HONDA ODYSSEY 1999-2004

- 1 Disconnect the negative battery terminal to prevent an accidental short circuit.
- 2 Unclip the radio trim bezel (including the climate control panel) and remove. Remove (4) Phillips screws securing the factory head unit and disconnect the wiring. (Fig. A)
- 3 Cut and remove the mounting tabs from the bottom of the **Rear Support Tray** (Fig. A). Cut and remove the slots on the bottom of the **ISO Brackets** (Fig. B). Locate tabs "B" on the ISO Brackets for mounting, cut and remove tabs "A" (Fig. C). Cut and remove all mounting clips on the **Radio Housing**. (Fig. B) Skip to step #3b on Page 10.

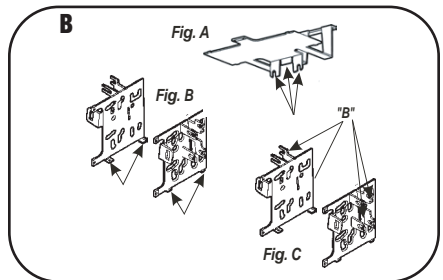
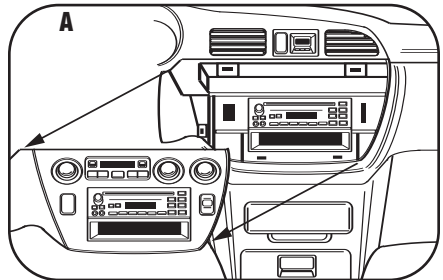

HONDA PRELUDE 1992-1996

- 1 Disconnect the negative battery terminal to prevent an accidental short circuit.
- 2 Remove (2) screws from the top of the console trim bezel. Slide the front seats back and remove (4) Phillips screws from each side of the bezel. Pull up on the console trim bezel and remove. Using an angled screwdriver, remove (2) screws securing the gear shifter bracket to the bezel. Remove (4) screws from the radio trim bezel, remove the factory head unit assembly and disconnect the wiring. (Fig. A)
- 3 Cut and remove the mounting tabs from the bottom of the **Rear Support Tray** (Fig. B). Cut and remove all mounting clips on the **Radio Housing** EXCEPT clips "F" and "H" (Fig. B). Cut and remove the slots on the bottom of the **ISO Brackets** (Fig. C). Skip to step #3b on Page 10.

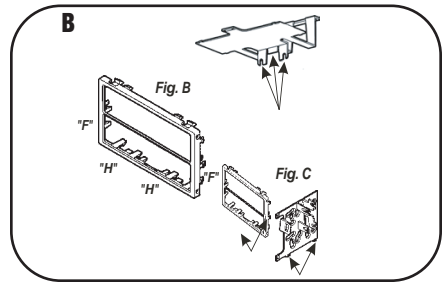
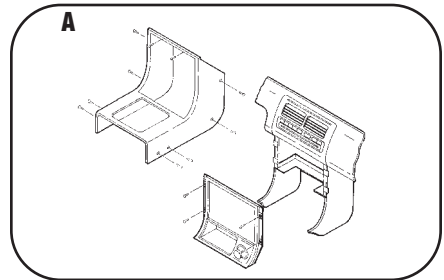

HONDA PRELUDE 1997-2001

- 1 Disconnect the negative battery terminal to prevent an accidental short circuit.
- 2 Using a panel removal tool, unclip the radio trim bezel and remove (some force may be required). Remove (4) Phillips screws securing the factory head unit/bracket housing assembly and disconnect the wiring. Remove (4) Phillips screws securing the factory head unit to the bracket housing and remove. (Fig. A)
- 3 Cut and remove all mounting clips on the **Radio Housing** EXCEPT clips "A" and "G". (Fig. B) Skip to step #3a on Page 9.

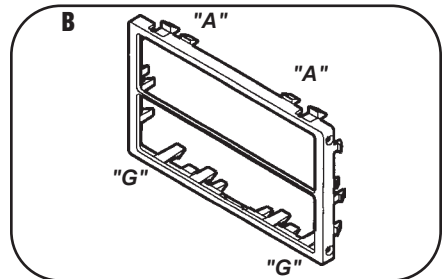
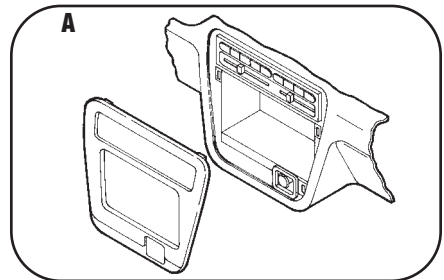

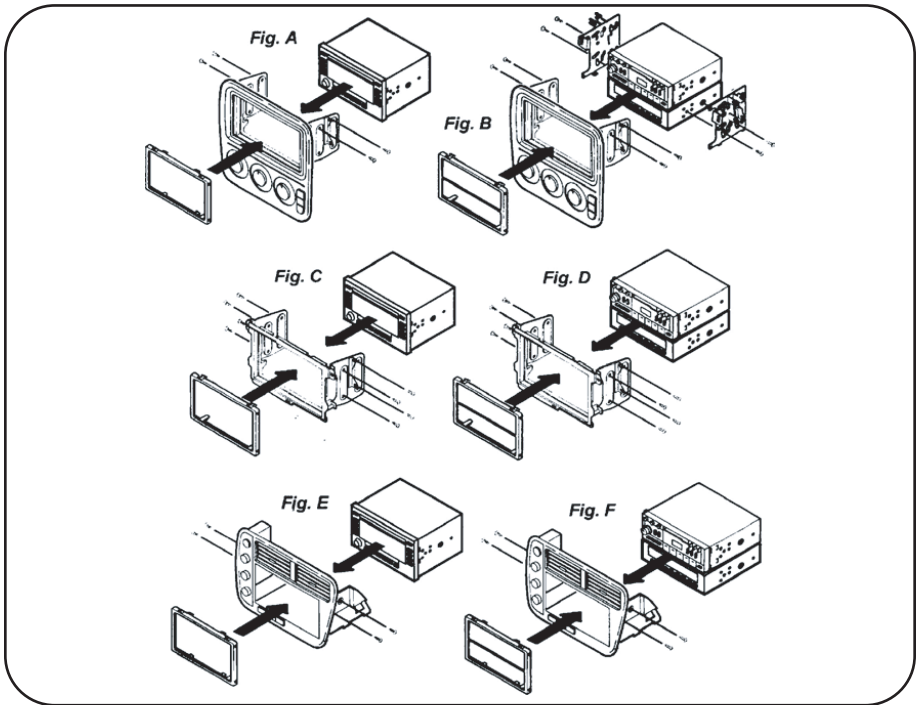

CRV: DOUBLE DIN HEAD UNITS: Slide the head unit into the factory bracket assembly. Align the holes in the brackets with the holes in the head unit and secure with the screws included with the unit. Cut and remove the dividing rib from the **Radio Housing** and snap the Housing into the opening (Fig. A). **Skip to step #4 on Page 11.**

ISO STACK HEAD UNITS: Slide the aftermarket head unit (and digital sound processor, equalizer, etc.) into the **ISO Brackets** and mount the lower unit to the Brackets with the screws included with the unit. Slide the units into the factory bracket assembly. Align the holes in the brackets with the holes in the upper unit and secure with the screws included with the unit. Snap the **Radio Housing** into the radio opening (Fig. B). **Skip to step #4 on Page 11.**

PRELUDE 1997-01: DOUBLE DIN HEAD UNITS: Slide the head unit into the factory bracket assembly. Align the holes in the brackets with the holes in the head unit and secure with the screws included with the unit. Cut and remove the dividing rib from the **Radio Housing** and snap the Housing into the opening (Fig. C). **Skip to step #4 on Page 11.**

ISO STACK HEAD UNITS: Slide the aftermarket head unit (and digital sound processor, equalizer, etc.) into the factory bracket assembly. Align the holes in the brackets with the holes in the units and secure with the screws included with the units. Snap the **Radio Housing** into the radio opening (Fig. D). **Skip to step #4 on Page 11.**

CIVIC 1999-00: DOUBLE DIN HEAD UNITS: Slide the head unit into the factory bracket assembly. Align the holes in the brackets with the holes in the head unit and secure with the screws included with the unit. Cut and remove the dividing rib from the **Radio Housing** and snap the Housing into the opening (Fig. E). **Skip to step #4 on Page 11.**

ISO STACK HEAD UNITS: Slide the aftermarket head unit (and digital sound processor, equalizer, etc.) into the factory bracket assembly. Align the holes in the brackets with the holes in the units and secure with the screws included with the units. Snap the **Radio Housing** into the radio opening (Fig. F). **Skip to step #4 on Page 11.**

DOUBLE DIN RADIO PROVISION STACKED ISO UNITS PROVISION

**Note: Refer also to the instructions included with the aftermarket radio.*

- 1 Disconnect the negative battery terminal to prevent an accidental short circuit.
- 2 **DOUBLE-DIN HEAD UNITS:** Cut and remove the dividing rib from the radio opening. Cut and remove all mounting tabs on the ISO Brackets, align the holes in the Brackets with the holes in the head unit and secure with the screws included with the unit. Slide the **Rear Support Tray** under the unit. Position the **Radio Housing** over the unit and mount to the ISO Brackets with (4) #6 x 1/4" Flat-head Screws supplied and to the **Rear Support Tray** with (2) #6 x 1/4" Flat-head Screws supplied (Fig. A). *Skip to Final Assembly on page 11 for Step 4.*
- 3 **ISO STACK HEAD UNITS:** Cut and remove all mounting tabs on the ISO Brackets, align the holes in the Brackets with the holes in the head units and secure with the screws included with the units. Slide the **Rear Support Tray** under the units. Position the **Radio Housing** over the units and mount to the ISO Brackets with (4) #6 x 1/4" Flat-head Screws supplied and to the Rear Support Tray with (2) #6 x 1/4" Flat-head Screws supplied (Fig. B). *Skip to Final Assembly on page 11 for Step 4.*

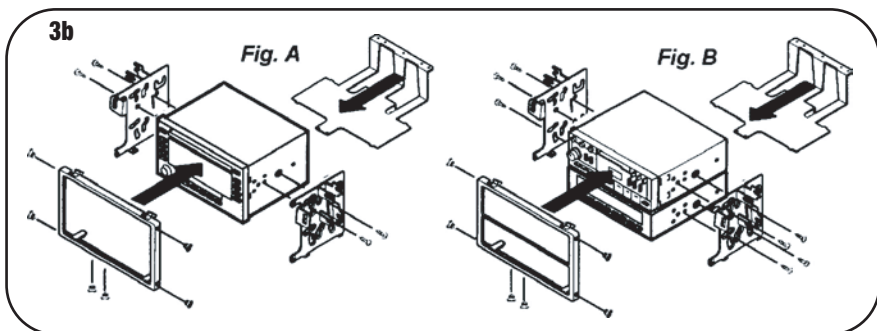

ACCORD 1994-97, CL: Secure the Mounting Bracket (mounted to the bottom of the Rear Support Tray) to the rear support provision in the sub-dash with (2) bolts previously removed. (*Skip to Final Assembly on page 11.*)

CRV, PRELUDE 1997-01, CIVIC 1999-00: Snap the head unit/trim bezel assembly into the sub-dash. (*Skip to Final Assembly on page 11.*)

ACCORD 1990-93, ODYSSEY 1995-98, PRELUDE 1992-96, INTEGRA, OASIS, VIGOR, TL: Snap the head unit/kit assembly into the sub-dash. ACCORD 1998-02, ODYSSEY 1999-02: Mount the head unit/kit assembly to the sub-dash with (4) screws previously removed in step #1. (*Skip to Final Assembly on page 11.*)

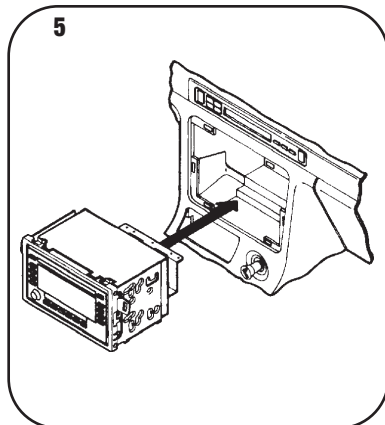

Step 4. FINAL ASSEMBLY

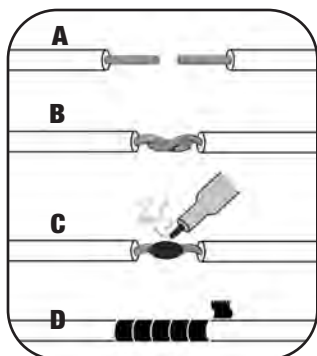

- (A) Strip wire ends back 1/2"**
- B) Twist ends together**
- C) Solder**
- D) Tape**

- 1** Locate the factory wiring harness in the dash. Metra recommends using the proper mating adapter and making connections as shown. (Isolate and individually tape off the ends of any unused wires to prevent electrical short circuit.)
- 2** Re-connect the negative battery terminal and test the unit for proper operation.
- 3** Reassemble radio and dash assemblies in reverse order of disassembly.

FINAL WIRING CONNECTIONS

Make wiring connections using the EIA color code chart shown below and the instructions included with the head unit. Metra recommends making connections as shown below; Strip, Splice, Solder, Tape. Isolate and individually tape off ends of any unused wires to prevent electrical short circuit.

METRA / EIA WIRING CODE

12V Ignition / Acc.	Red
12V Batt / Memory.	Yellow
Ground.	Black*
Power Antenna.	Blue
Amp Turn-On	Blue / White
Amp Ground.	Black / White
Illumination	Orange
Dimmer	Orange / White

Right Front (+)	Gray
Right Front (-).	Gray/ Black
Left Front (+)	White
Left Front (-).	White / Black
Right Rear (+)	Violet
Right Rear (-).	Violet / Black
Left Rear (+)	Green
Left Rear (-)	Green / Black

***NOTE:** When a Black wire is not present, ground radio to vehicle chassis.
All colors may not be present on all leads due to manufacturer's specifications.

95-7801 INSTRUCTIONS



1-800-221-0932



www.metraonline.com

REV. 04/21/08 © COPYRIGHT 2001-2008 METRA ELECTRONICS CORPORATION INST95-7801