

KIT FEATURES

- ▶ Shaft unit provisions

KIT COMPONENTS

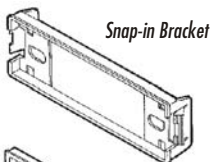

Snap-in Bracket

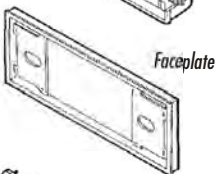

Faceplate

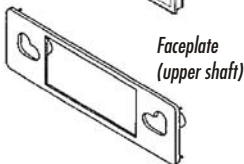

Faceplate
(upper shaft)



(4) Locking Tabs
(MERCEDES)



Shaft Masks
(upper shaft)

TOOLS REQUIRED



Phillips screwdriver



Cutting tool



Adjustable wrench



99-9001 AW-140UV DW-9001 INSTALLATION INSTRUCTIONS

APPLICATIONS

**MOUNTS AN AFTERMARKET 2-SHAFT HEAD UNIT TO VEHICLES EQUIPPED WITH A STANDARD DIN RADIO OPENING
(SEE INSIDE FOR SPECIFIC APPLICATIONS)**



☎ 1-800-221-0932 💻 www.metraonline.com

© COPYRIGHT 2001 METRA ELECTRONICS CORPORATION

rev. 230701

APPLICATIONS

ACURA

Integra 1986-89
Legend 1986-89

ALFA ROMEO

Milano 1980-89
Spider Veloce 1987-93
164 L/S 1991-93

AUDI

80/90 1988-96
100/200 1989-95
4000 1980-87
5000 1978-88
S4 1992-93

BMW

3-Series 1977-96
5-Series 1975-96
6-Series 1977-89
7-Series 1978-96
8-Series 1991-93
Z3 1997-00

DAIHATSU

Charade 1989-92

DODGE

Colt 1993-94
D50 Pickup 1988-93

EAGLE

Summit 1993-95

FIAT

Brava 1979-83
Spider 1988-89
Strada 1977-83
X19 1979-89

GEO

Metro 1989-91
Tracker 1989-91

HONDA

Accord 1982-89
CRX 1984-91
Civic 1982-95
Del Sol 1993-97
Prelude 1983-91

JAGUAR

XJ6 1988-93

LANCIA

Beta 1979-81

MASERATI

Spyder 1985-90

MERCEDES

190 Series 1984-93
240D 1981-84
260E 1986-93
300E 1986-96
300SD 1981-85
300SDL 1986-87
300SE 1988-96
300SEL 1988-96
300TD 1981-96
300TE 1981-96
350 Series 1990-96
380SL 1981-96
380SE 1981-96
380SEL 1981-96
380SEC 1981-96
420SEL 1980-86
500SE 1984-93
500SEL 1984-93
500SEC 1984-93
560SEL 1986-93
560SEC 1986-93
C-Class 1996-00

MERCEDES (cont.)

CL-Class 1998-00
E-Class 1996-00
M-Class 1999-00
S-Class 1999-00
SL-Class 1997-00

MINI

Mighty Max 1987-95
Mirage 1993-96

PEUGEOT

405 1989-93
505 1984-93

PONTIAC

LeMans 1988-93

PORSCHE

911 1973-96
924 1977-82
924S 1986-88
928 1980-96
944 1986-93
968 1992-96

RENAULT

Alliance 1984-85
Encore 1984-85
Fuego 1982-85
LeCar 1976-83
18i 1979-83

SAAB

900 1979-96
9000 1986-96

STERLING

825 1987-88
827 1989-92

SUZUKI

Samurai 1988½-93

SUZUKI (cont.)

Samurai 1988½-93
Sidekick 1989-91
Swift 1989-91
X-90 1996-97

VOLKSWAGEN

Bus 1968-79
Cabriolet 1985-00
Corrado 1990-93
Dasher 1976-81
Fox 1987-93
Golf 1986-00
GTI 1999-00
Passat 1990-96
Pickup 1980
Rabbit 1975-80
Scirocco 1982-88
Super Beetle 1973-79
Quantum 1982-88
Vanwagon 1980-92

ALL VEHICLES

1

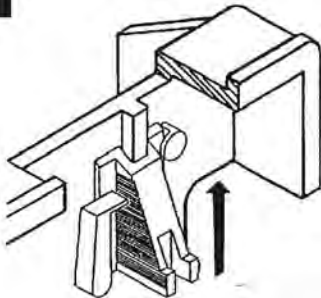

MERCEDES: Slide the **Locking Tabs** onto the guides located on the front corners of the **Snap-in Bracket**.

2

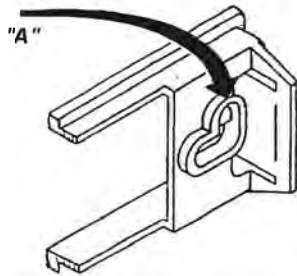

Slide the aftermarket head unit into the **Snap-in Bracket**. If the shafts of the head unit do not pass easily through the kit, cut and remove the upper-shaft tabs from the shaft openings. ("A")

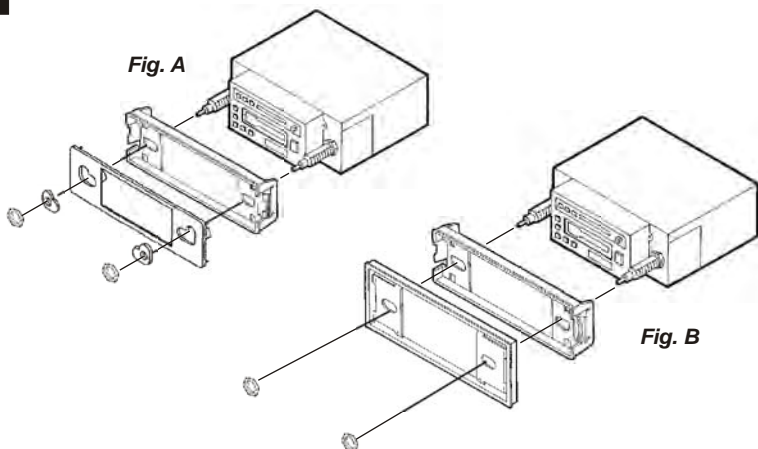
3

If the upper-shaft tabs were removed in step #2, attach the **Faceplate** and **Shaft Masks (for upper-shaft locations)** to the **Snap-in Bracket**. Slide the aftermarket head unit into the kit and secure with shaft nuts. (see Fig. A)

If the upper-shaft tabs were **NOT** removed in step #2, attach the **Faceplate** to the **Snap-in Bracket**. Slide the DIN cage into the kit and secure by bending the metal locking tabs down. Slide the aftermarket head unit into the cage until secure. (see Fig. B)

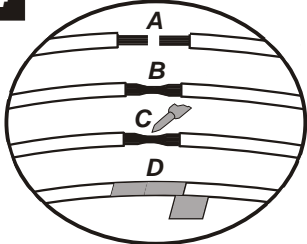
4

- A) Strip wire ends back $\frac{1}{2}$ "
- B) Twist ends together
- C) Solder
- D) Tape

Locate the factory wiring harness in the dash. Metra recommends using the proper mating adaptor and making connections as shown. (Isolate and individually tape off the ends of any unused wires to prevent electrical short circuit).

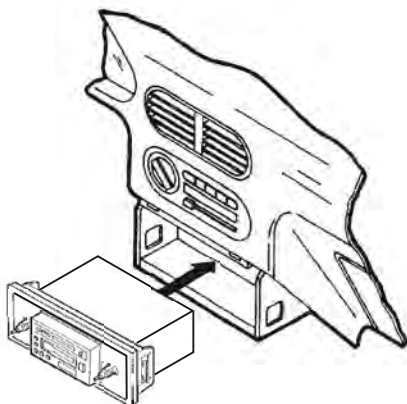
5

Re-connect the battery terminal and test the unit for proper operation. Snap the head unit/kit assembly into the sub-dash.