

MSD **IGNITION** **INSTALLATION INSTRUCTIONS**

MSD Pro-Billet Chevrolet V8 Distributor with Slip Collar, PN 85561 Extra Tall, PN 8547 with Locked-Out Timing, PN 85501

Important: Read these instructions before attempting the installation.

Parts Included:

1 - Pro-Billet Distributor	1 - Advance Kit (PN 85561, 8547 only)
1 - Rotor, PN 8467	1 - Gasket
1 - Distributor Cap, PN 8433	1 - Tube of Gear Lubricant
1 - Wire Retainer	2 - O-Rings
2 - 1.5" Self Tapping Screws	
2 - 10-32 x 3/4" Socket Head Screws	

WARNING: Before installing the MSD Distributor, disconnect the battery cables. When disconnecting the battery cables, always remove the Negative (-) cable first and install it last.

Note: The terminals of this Distributor require spark plug style terminals. You may need to change the terminals and boots of your wires. MSD offers two kits, PN 8849 or PN 8848 that are supplied with nine boots and terminals.

Note: MSD Gear (PN 8531) is required for replacement due to the .500" diameter shaft.

Note: A replacement Black cap is available as PN 84333.

TIMING FUNCTIONS

Note: The PN 85501 does not have a mechanical advance.

Before continuing with the installation, here are a few definitions you should be aware of:

Initial Timing: This is the base timing (also referred to as idle timing) of the engine before the centrifugal advance begins.

Centrifugal Advance: The centrifugal (or mechanical) advance mechanism is made up of weights, springs, advance cams, and an advance stop bushing. The amount and rate of advance that your distributor is capable of is determined by the centrifugal timing. If you ever wish to lock out the centrifugal advance, refer to the centrifugal advance section.

Total Timing: This is the total of the initial timing plus the centrifugal advance added together. Example: 10° Initial + 25° centrifugal = 35° Total Timing. (When checking Total timing, disconnect the vacuum canister and plug the vacuum source.)

Note: MSD Distributors are supplied with the heavy (slow) advance springs installed. This is to prevent detonation in certain applications. Review the information on pages 2-4 to determine the best advance curve for your application.

CHOOSING AN ADVANCE CURVE

The function of the advance curve is to match the ignition timing to the burning rate of the fuel and speed (rpm) of the engine. Any factor that changes the burning rate of the fuel or the engine speed can cause a need for an ignition timing change. Figure 1 shows some of the factors that will affect engine timing.

FACTOR	Advance Timing For	Retard Timing For
Cylinder Pressure	Low	High
Vacuum	High	Low
Energy of Ignition	Low	High
Fuel Octane	High	Low
Mixture (Air/Fuel)	Rich	Lean
Temperature	Cool	Hot
Combustion Chamber Shape	Open	Compact
Spark Plug Location	Offset	Center
Combustion Turbulence	Low	High
Load	Light	Heavy

Figure 1 Ignition Timing Factors.

As you can see from the chart, most factors will change throughout the range of the engine operation. The timing mechanism of the distributor must make timing changes based on these factors.

Example: An engine has 11:1 compression with a high energy ignition. With the specifications given, you will have to retard the timing for the high compression and high energy ignition. By comparing the engine's specifications against the chart, a usable timing guideline can be found. Engines with a combination of items from both columns will require a timing that is set in the mid range.

Obviously a full technical explanation of correct ignition timing would be very complicated. The best way to arrive at a suitable ignition curve for your engine is to use the Ignition Timing Factors Chart as a guide and compare it to the Advance Graphs in Figure 4 until a suitable curve is found. When selecting your advance curve, use detonation (engine ping) as an indicator of too much advance, and a decrease in power as an indicator of too little advance.

TIPS ON SELECTING AN ADVANCE CURVE

- Use as much initial advance as possible without encountering excessive starter load.
- Start the centrifugal advance just above the idle rpm.
- The starting point of the centrifugal advance curve is controlled by the installed length and tension of the spring.
- How quickly the centrifugal advance (slope) comes in is controlled by the spring stiffness. The stiffer the spring, the slower the advance curve.
- The amount of advance is controlled by the advance bushing. The bigger the bushing, the smaller the amount of advance.

CENTRIFUGAL ADVANCE CURVE

SELECTING THE ADVANCE SPRINGS

The rate, or how quick the advance comes in is determined by the type of springs which are installed on the distributor. The MSD distributors are equipped with two Heavy Silver springs installed. These will give you the slowest advance curve possible (Figure 2). The parts kit contains two additional sets of springs which can be used to match the advance curve to your particular application. Refer to the Spring Combination Chart (Figure 3) for combinations that can be achieved.

To change the springs, remove the cap and rotor and use needlenose pliers to remove the springs. Be sure the new springs seat in the groove on the pin.

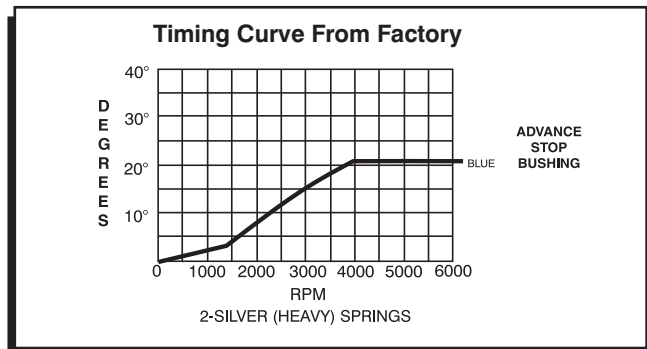

Figure 2 The Factory Equipped Curve.

SPRING COMBINATION	RATE OF ADVANCE	FIGURE 4
2- Heavy Silver	SLOWEST	A
1- Heavy Silver		B
1- Light Blue		C
1-Heavy Silver		D
1-Light Silver		E
2- Light Blue		F
1- Light Silver		FASTEST

Figure 3 Spring Combination Chart.

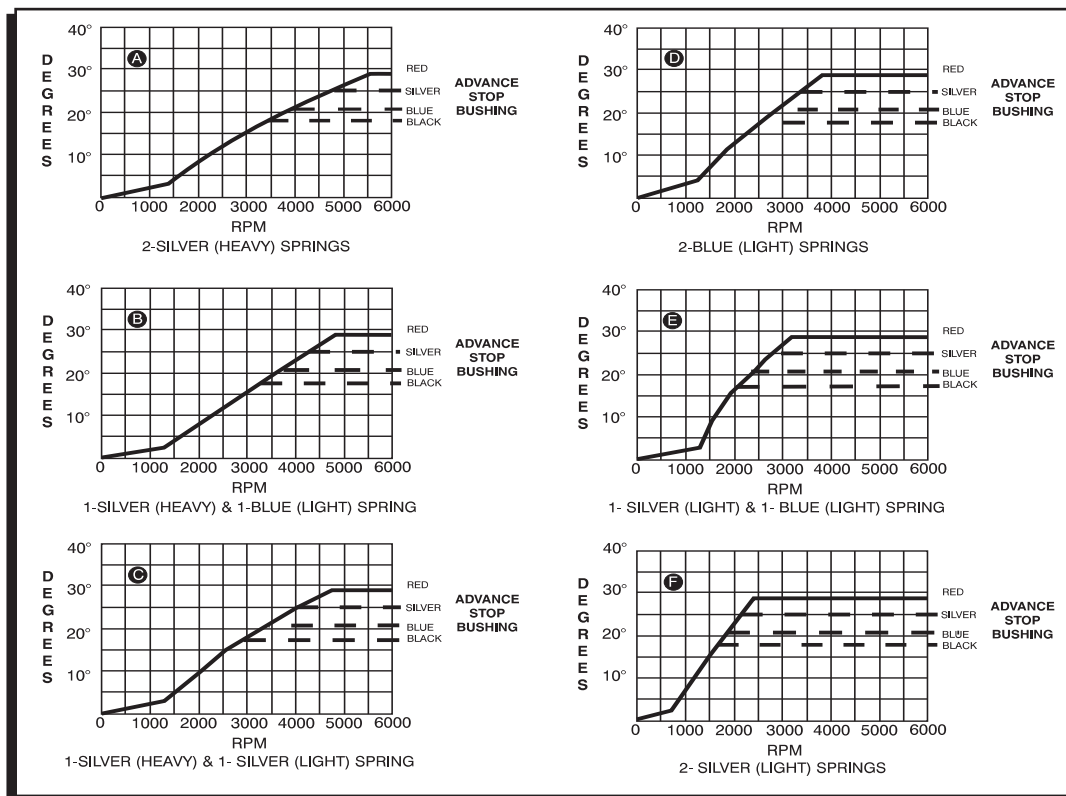

Figure 4 Advance Curves.

SELECTING THE ADVANCE STOP BUSHING

Three different advance stop bushings are supplied in the distributor kit. The distributor comes with a Blue (21°) bushing already installed. If a different amount of centrifugal advance is desired, follow the next procedure to change the bushings. The chart in Figure 5 gives the size and approximate degrees for the corresponding bushings.

CHANGING THE ADVANCE STOP BUSHINGS

1. Remove the distributor cap and rotor.
2. Remove the locknut and washer on the bottom of the advance assembly (Figure 6).
3. Remove the bushing and install the new one. Install the washer and locknut. Do not over tighten.

BUSHING SIZE	APPROXIMATE CRANKSHAFT DEGREES
Red-Smallest	28
Silver	25
Blue	21
Black-Largest	18

Figure 5 Advance Stop Bushing Chart.

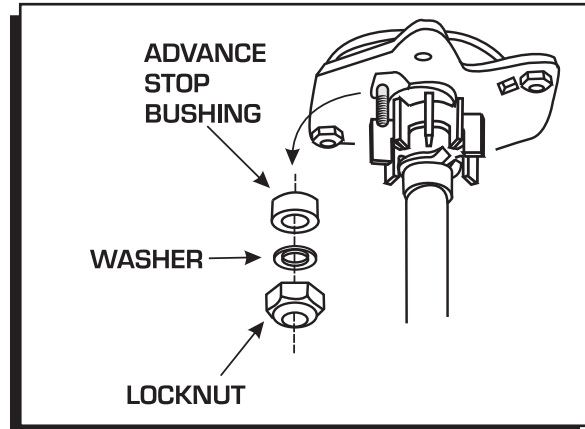

Figure 6 Changing the Advance Stop Bushing.

LOCKING OUT THE CENTRIFUGAL ADVANCE

1. Remove the advance components including the springs, weights and the advance stop bushing from the advance assembly.
2. Remove the roll-pin from the drive gear and remove the gear from the shaft.
3. Slide the shaft two inches out of the housing.
4. Rotate the shaft 180° and insert the advance stop bushing pin into the small hole on the advance plate (Figure 7).
5. Install the locknut and washer to the advance stop bushing pin. This locks the advance in place. Do not over tighten.
6. Install the drive gear and roll-pin.

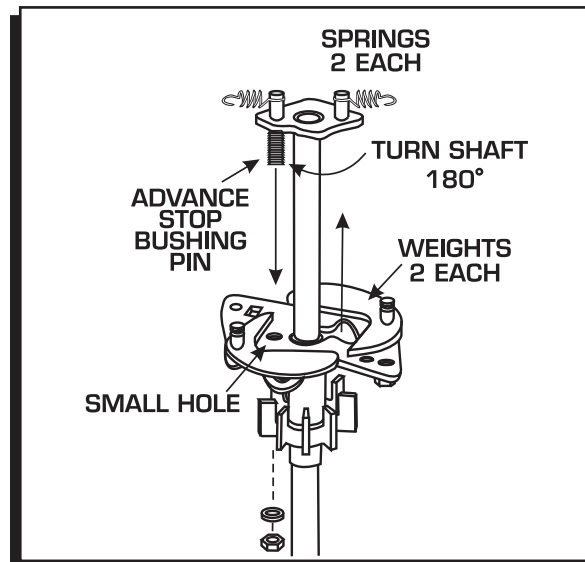

Figure 7 Locking Out the Advance.

ADJUSTING THE SLIP COLLAR

Before installing the Pro-Billet Distributor, the slip collar adjustment must be set. MSD offers a special tool, the 3-In-1 Distributor Set Up Tool, PN 8599, to make these adjustments accurately. If the tool is not available, follow this procedure.

1. Install the gasket to the housing then loosen the slip collar and insert the distributor into the engine until it bottoms out against the oil pump drive.
2. After it bottoms out, raise the distributor 0.010" - 0.030" then slide the slip collar down into position and tighten it.

CHECKING GEAR MESH

It is recommended to check for proper gear mesh between the cam gear and distributor gear. To do this, coat the distributor gear with moly grease and install the distributor. Next, crank the engine over several times. Before pulling the distributor out, make sure the rotor is in the position that lines up with the original removal mark. Then pull the distributor out and inspect the gear pattern shown on the grease. The proper mesh will leave an even pattern in the middle of the gear. Adjust the slip collar to obtain the correct mesh.

Checking the Oil Pump to Distributor Shaft Overlap

The proper overlap between the distributor shaft and the oil pump shaft is very important. The tongue of the distributor shaft should fit into the groove of the oil pump shaft by at least 1/4". To check this:

1. Measure the distance between the base of the slip collar to the tip of the distributor shaft (Figure 8).
2. Using a straight edge, measure the distance from the intake manifold distributor flange to the top of the oil pump intermediate shaft (Figure 8).
3. Take the two measurements and subtract them. The difference is the overlap. If there is not enough clearance or too much clearance, a different oil pump intermediate shaft is required.

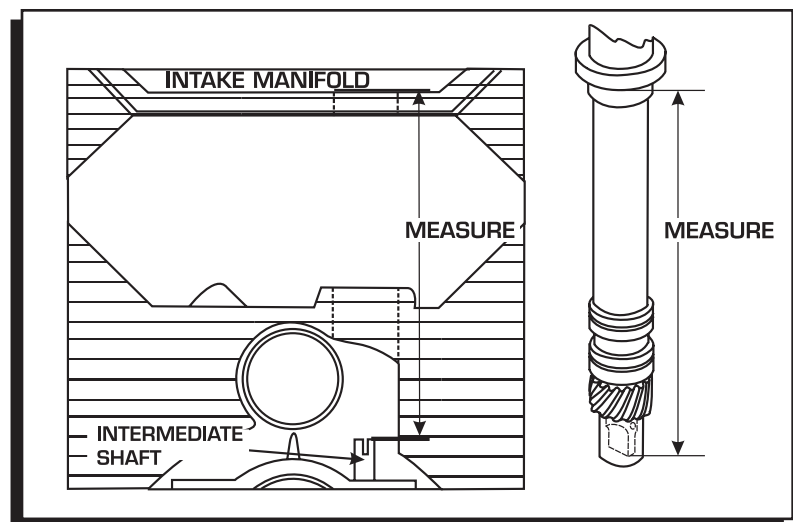

Figure 8 Measuring Oil Pump Shaft Overlap.

INSTALLING THE DISTRIBUTOR

1. Remove the existing distributor cap without disconnecting any of the spark plug wires.
2. With the cap off, crank the engine until the rotor is aimed at a fixed point on the engine or firewall. Note this position by making a mark (Figure 9).
3. Place the distributor cap back on and note which plug wire the rotor is pointing to. MARK THE SPARK PLUG WIRES and remove the distributor cap.
4. Disconnect the wiring from the distributor.
5. Loosen the distributor hold down clamp and slide the clamp out of the way.
6. Lift the distributor out of the engine. Note that the rotor rotates as you lift the distributor out. This is due to the helical cut gear and should be taken into consideration when installing the new distributor.
7. Install the gasket and apply a liberal amount of the supplied lubricant to the distributor gear. (The supplied O-rings can **only** be used if the block has been modified as shown in Figure 10.)
8. Install the distributor making sure that the rotor comes to rest pointing at the fixed mark. If the distributor will not fully seat with the rotor pointing to the marked position, you may need to rotate the oil pump shaft until the rotor lines up and the distributor fully seats.
9. Position and tighten the hold down clamp onto the distributor.
10. Install the distributor cap and spark plug wires one at a time to ensure correct location. A wire retainer is supplied to secure the wires in place. Align the mounting bosses and use the supplied 1.5" self-tapping Phillips screws to hold the retainer in place.

Installation Option: This Cap can also be bolted down to an MSD Pro-Billet or Billet Distributor base with the supplied hardware. To accomplish this, the spring clips must be cut off (Figure 11).

Note: When the cap is bolted down, the location of the spark plug wires must be changed.

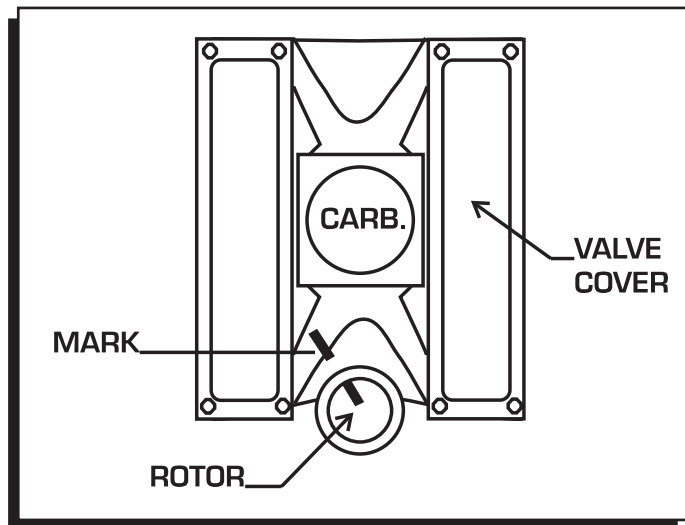

Figure 9 Marking the Rotor Location.

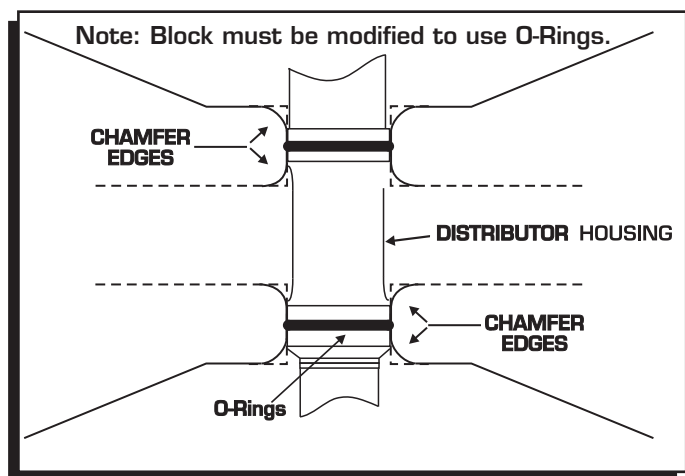

Figure 10 Modified Block for use with O-Rings.

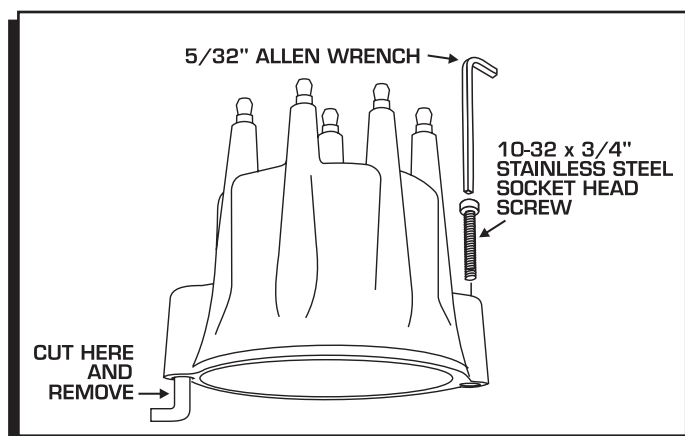

Figure 11 Optional Installation by Bolting Cap Down.

WARNING: High voltage is present on the coil terminals. Do not touch the terminals or coil tower when the engine is cranking or running.

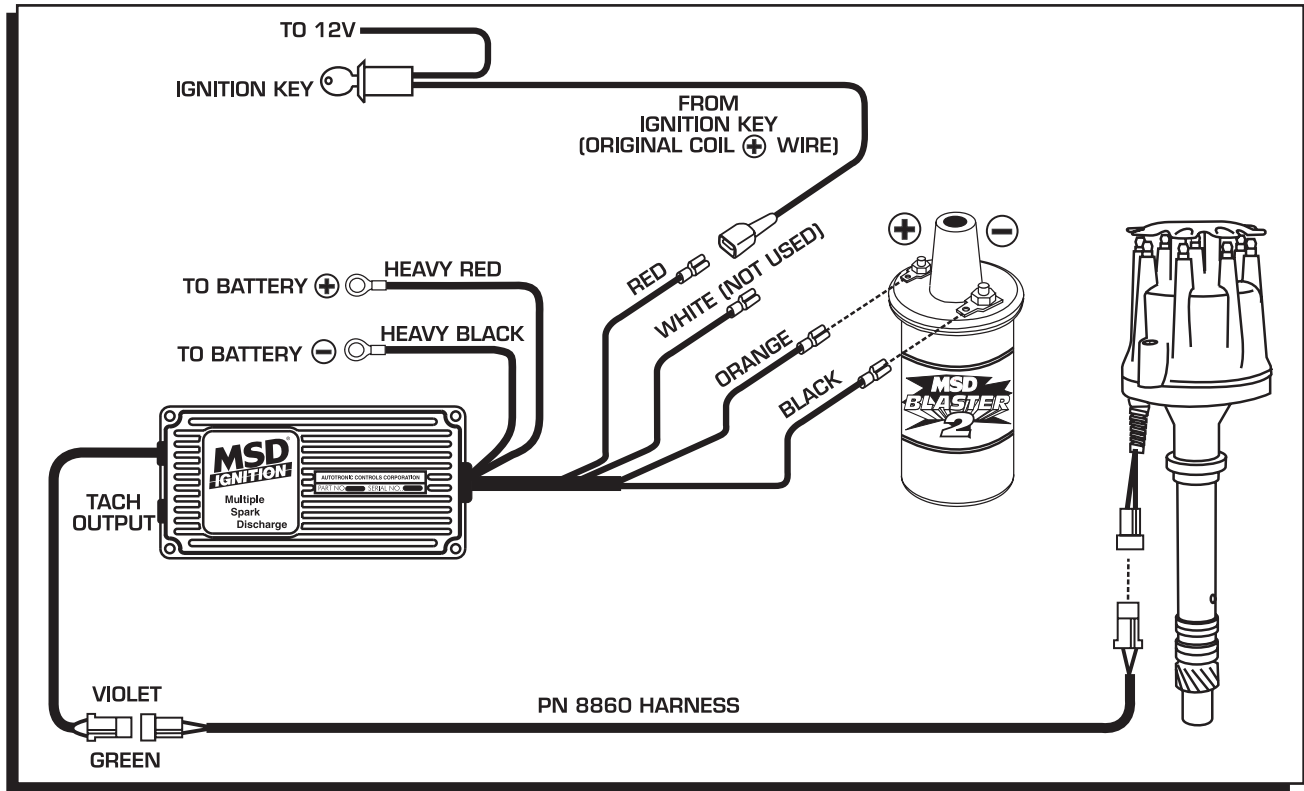

Figure 12 Wiring to an MSD 6-Series Ignition Control.

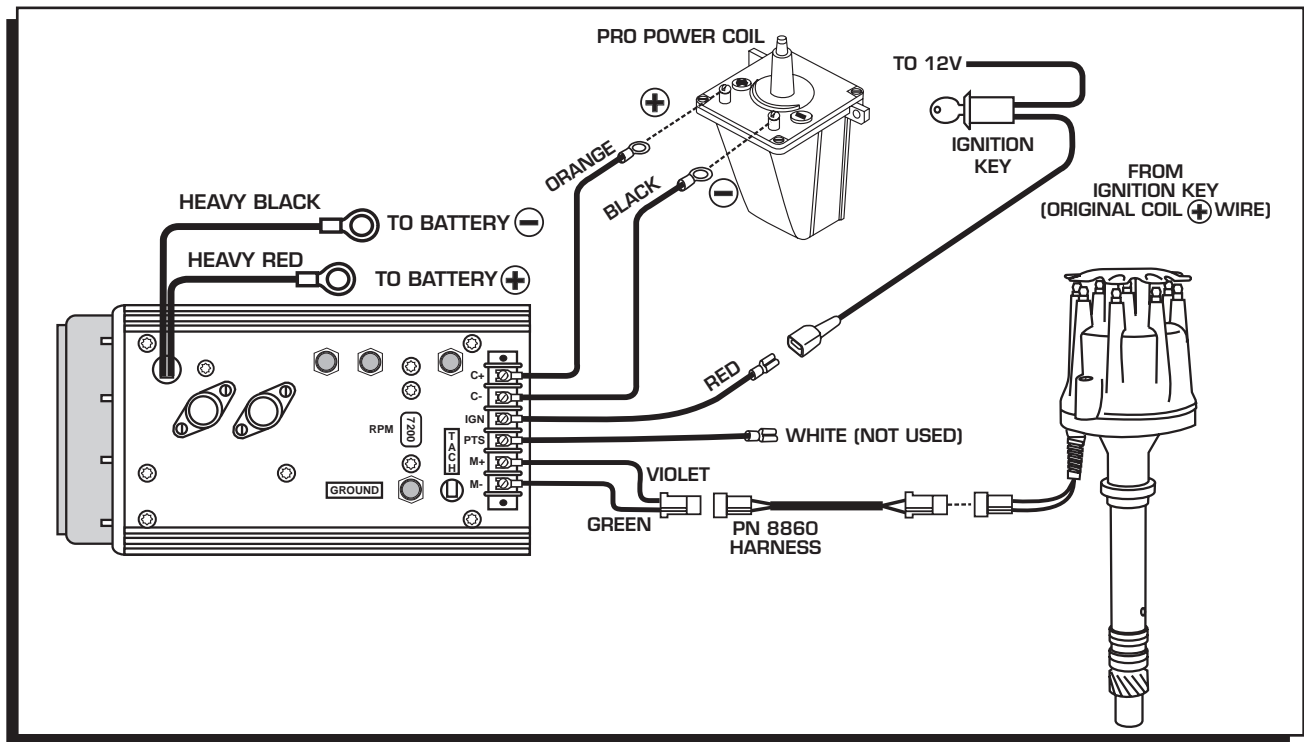

Figure 13 Wiring to an MSD 7-Series Ignition Control.

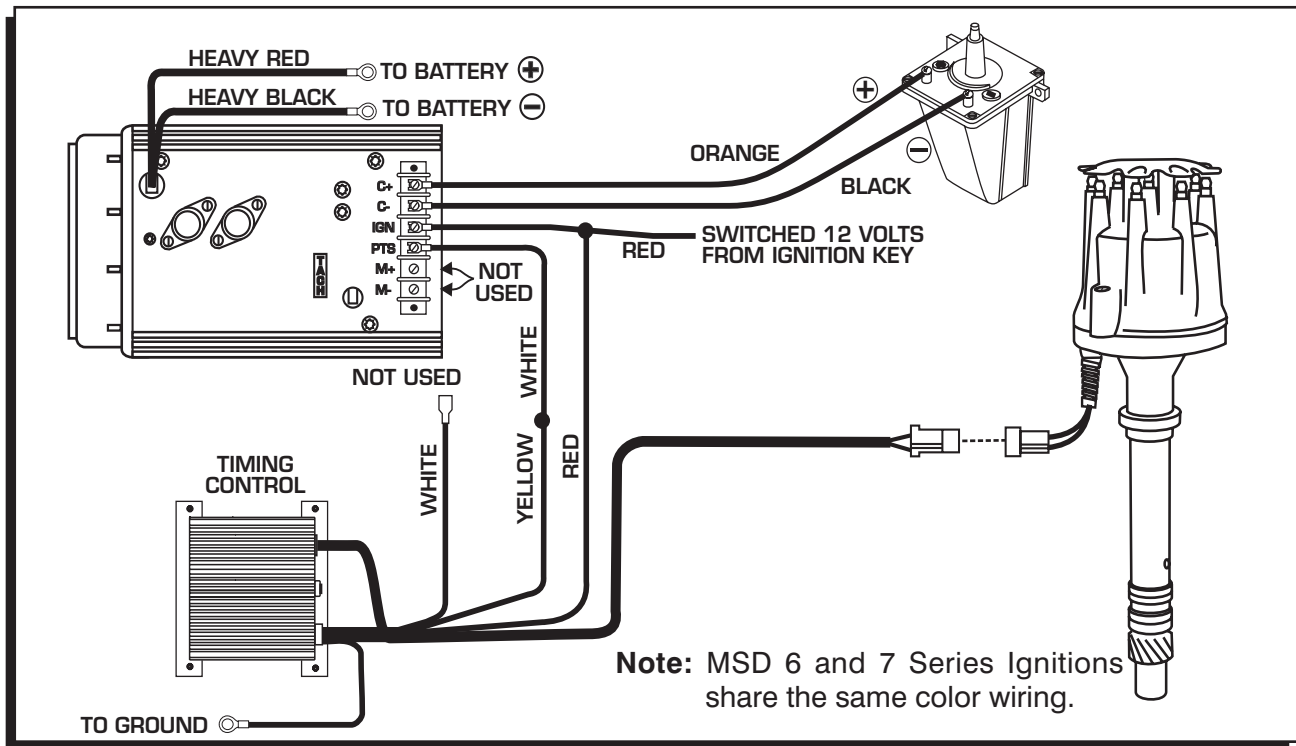

Figure 14 Wiring with an MSD 7-Series Ignition and Timing Control.

Service

In case of malfunction, this MSD component will be repaired free of charge according to the terms of the warranty. When returning MSD components for warranty service, **Proof of Purchase** must be supplied for verification. After the warranty period has expired, repair service is based on a minimum and maximum fee.

All returns must have a Return Material Authorization (RMA) number issued to them before being returned. To obtain an RMA number please contact MSD Customer Service at 1 (888) MSD-7859 or visit our website at www.msdisignition.com/rma to automatically obtain a number and shipping information.

When returning the unit for repair, leave all wires at the length in which you have them installed. Be sure to include a detailed account of any problems experienced, and what components and accessories are installed on the vehicle. The repaired unit will be returned as soon as possible using Ground shipping methods (ground shipping is covered by warranty). For more information, call MSD Ignition at (915) 855-7123. MSD technicians are available from 7:00 a.m. to 6:00 p.m. Monday - Friday (mountain time).

Limited Warranty

MSD IGNITION warrants this product to be free from defects in material and workmanship under its intended normal use*, when properly installed and purchased from an authorized MSD dealer, for a period of one year from the date of the original purchase. This warranty is void for any products purchased through auction websites. If found to be defective as mentioned above, it will be repaired or replaced at the option of MSD Ignition. Any item that is covered under this warranty will be returned free of charge using Ground shipping methods.

This shall constitute the sole remedy of the purchaser and the sole liability of MSD Ignition. To the extent permitted by law, the foregoing is exclusive and in lieu of all other warranties or representation whether expressed or implied, including any implied warranty of merchantability or fitness. In no event shall MSD Ignition or its suppliers be liable for special or consequential damages.

*Intended normal use means that this item is being used as was originally intended and for the original application as sold by MSD Ignition. Any modifications to this item or if it is used on an application other than what MSD Ignition markets the product, the warranty will be void. It is the sole responsibility of the customer to determine that this item will work for the application they are intending. MSD Ignition will accept no liability for custom applications.