

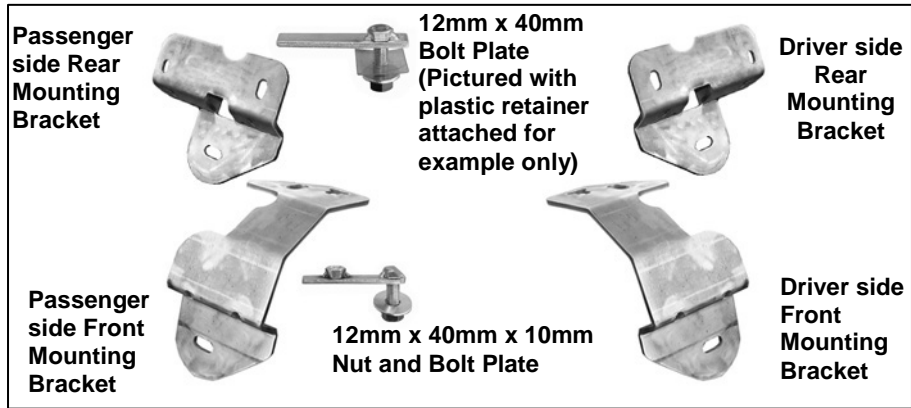

Installation Instructions
Sure Step
 (Part #FN1990-S4B/FN1990-S4S)
 09 Ford F-150 Super Crew

PARTS LIST:

| | | | |
|---|--|---|---|
| 1 | Driver/Left Sidebar | 4 | 12mm ID x 30.1mm OD x 3mm Flat Washers |
| 1 | Passenger/Right Sidebar | 4 | 12mm Lock Washers |
| 1 | Driver/Left Front Mounting Bracket | 4 | 12mm Hex Nuts |
| 1 | Passenger/Right Front Mounting Bracket | 4 | 10-1.50mm x 35mm Hex Bolts |
| 1 | Driver/Left Rear Mounting Bracket | 6 | 10mm x 30mm OD x 2.1mm Flat Washers |
| 1 | Passenger/Right Rear Mounting Bracket | 4 | 10mm Lock Washers |
| 2 | 12mm x 40mm x 10mm Nut and Bolt Plate | 2 | 10mm Hex Nuts |
| 2 | 12mm x 40mm Bolt Plates | 4 | 8-1.25mm x 30mm Hex Head Bolts |
| 4 | 11mm Plastic Retainers | 4 | 8mm ID x 22mm OD x 1.5mm Flat Washers (Outer) |
| 2 | 9mm Plastic Retainers | 4 | 8mm ID x 17.1mm OD x 1.3mm Flat Washers (Inner) |
| 4 | 1/2" x 2" Hex Head Bolts | 4 | 8mm Lock Washers |
| 4 | 1/2" x 1-1/4" OD x 3/32" Flat Washers | 4 | 8mm Hex Nuts |
| 4 | 1/2" Lock Washers | | |



PROCEDURE:

- REMOVE CONTENTS FROM BOX. VERIFY ALL PARTS ARE PRESENT. READ INSTRUCTIONS CAREFULLY BEFORE STARTING INSTALLATION. DRILLING IS REQUIRED. ASSISTANCE RECOMMENDED.**
- Starting at the front of the driver side of the vehicle, remove the plastic pin, the two small hex bolts and the metal clips holding the bottom of the fender to the body, **(Figure 1A)**. **NOTE:** Use a small flat screwdriver to spread the clip apart for easy removal. Due to body panel misalignment from the factory, it may be necessary to open these holes slightly with a 3/8" drill bit, **(Figure 1B)**.
- Next, locate the round and square holes in the floor panel next to the body mount, **(Figure 2)**. Select (1) 12mm x 40mm x 10mm Nut and Bolt Plate and thread (1) 11mm Plastic Retainer part way onto it. Insert the Nut and Bolt Plate into the square hole in the floor. Line up the nut on the Nut and Bolt Plate with the round hole. **IMPORTANT:** The Plastic Retainer is designed to prevent the Bolt Plate from falling into the body cavity and to aid in mounting the Bracket. After inserting, thread the Plastic Retainer down

For Technical Support/Warranty Information please call 310-762-9944



Installation Instructions

Sure Step

(Part #FN1990-S4B/FN1990-S4S)

09 Ford F-150 Super Crew

but leave it loose enough to move the Nut and Bolt Plate around during installation of the Mounting Bracket. **NOTE:** For passenger side installation, remove the ground strap next to the mounting holes.

4. Select the driver side front Mounting Bracket and hold it at a slight angle against the body. Move the top of the Bracket into position with the threaded end of the Nut and Bolt Plate lined up with the T-Slot in the Bracket. The top of the Bracket is designed to fit snug in position between the body mount and the lip on the body so it may take a couple of tries to get the Bracket into the correct position, **(Figure 3)**. Once the top of the Bracket is properly lined up in the T-Slot, rotate the bottom of the Bracket into position with the holes in the pinch weld. Secure the 12mm threaded end of the Nut and Bolt Plate with (1) 12mm Flat Washer, (1) 12mm Lock Washer and (1) 12mm Hex Nut. Rotate the Nut and Bolt Plate around to line up the Nut with the remaining hole and thread (1) 10mm x 35mm Hex Bolt, (1) 10mm Flat Washer and (1) 10mm Lock Washer into the Nut, **(Figure 4)**. Do not tighten at this time.
5. Align the holes in the pinch weld with the holes in the front Mounting Bracket. Insert (2) 8mm x 30mm Hex Bolts with (2) 8mm x 22mm OD x 1.5mm Large Flat Washers up from below and secure with (2) 8mm x 17.1mm OD x 1.3mm Small Flat Washers, (to clear the bracket), (2) 8mm Lock Washers and (2) 8mm Hex Nuts, **(Figure 5)**. Do not tighten hardware at this time.
6. Moving to the driver side rear, remove the tape covering the holes on the inner body panel. Select (1) 12mm Bolt Plate and thread (1) 11mm Plastic Retainer part way onto it. Insert the Bolt Plate and Retainer into the rear mounting hole, **(Figure 6A)**. **IMPORTANT:** The Plastic Retainer is designed to prevent the Bolt Plate from falling into the body cavity and to aid in mounting the Bracket, **(Figure 6B)**. Once the Bolt Plate has been inserted, thread the Plastic Retainer all of the way down to snug up against the body.
7. Hang the driver side Rear Mounting Bracket from the Bolt Plate and Retainer and secure it with the included (1) 12mm Lock Washer, (1) 12mm Flat Washer, and (1) 12mm Hex Nut. Insert (1) 10mm x 35mm Hex Bolt, (1) 10mm Flat Washer with (1) 9mm Plastic Retainer into the hole at the rear of the Mounting Bracket from the outside-in, **(Figure 7A)**. **NOTE:** The Plastic Retainer is intended to protect the outer painted surface of the body. Thread the Plastic Retainer onto the Hex Bolt so that it is between the 10mm Flat Washer and the body, **(Figure 7B)**. Secure the Bracket with (1) 10mm Lock Washer, (1) 10mm Flat Washer and (1) 10mm Hex Nut. Do not tighten hardware at this time.
8. Attach the Sidebar to the Mounting Brackets using the included (2) 1/2" x 2" Hex Head Bolts, (2) 1/2" Flat Washers, and (2) 1/2" Lock Washers. Do not tighten hardware at this time.
9. Align the Sidebar and adjust as required. Once properly aligned, tighten all hardware.
10. Repeat steps 2-9 for passenger Sidebar installation. **NOTE:** For passenger side installation, replace the ground strap next to the mounting holes for the front Mounting Bracket removed in Step 3.
11. Do periodic inspections to the installation to make sure that all hardware is secure and tight.

To protect your investment, wax this product after installing. Regular waxing is recommended to add a protective layer over the finish. Do not use any type of polish or wax that may contain abrasives that could damage the finish.

For stainless steel: Aluminum polish may be used to polish small scratches and scuffs on the finish. Mild soap may be used also to clean the Sidebar.

For gloss black finishes: Mild soap may be used to clean the Sidebar.

For Technical Support/Warranty Information please call 310-762-9944

Smittybilt, 400 West Artesia Blvd, Compton, CA 90220

Page 2 of 6



Installation Instructions
Sure Step
(Part #FN1990-S4B/FN1990-S4S)
09 Ford F-150 Super Crew

Driver Side Installation Pictured

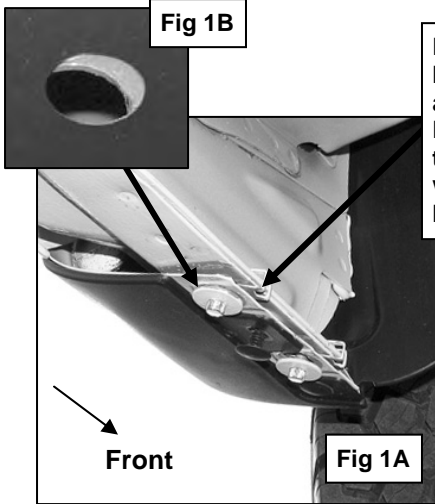

Remove these two hex bolts, metal clips and the plastic pin. Drill a 3/8" hole through the pinch weld to clearance holes if necessary



Insert the Nut and Bolt Plate into this square hole and line up the nut with the round hole. Thread the plastic retainer only part way down the threaded end of the bolt. On passenger side installation, remove the ground strap for access. Replace after Bracket installation

Driver Side Installation Pictured



Hold Bracket in place on top of this lip on the body

Hold the Bracket at an angle. Insert the top of the Bracket between this lip on the body and the body mount. Line up the threaded Nut and Bolt Plate with the T-Slot in the Bracket

For Technical Support/Warranty Information please call 310-762-9944



Installation Instructions
Sure Step
 (Part #FN1990-S4B/FN1990-S4S)
 09 Ford F-150 Super Crew

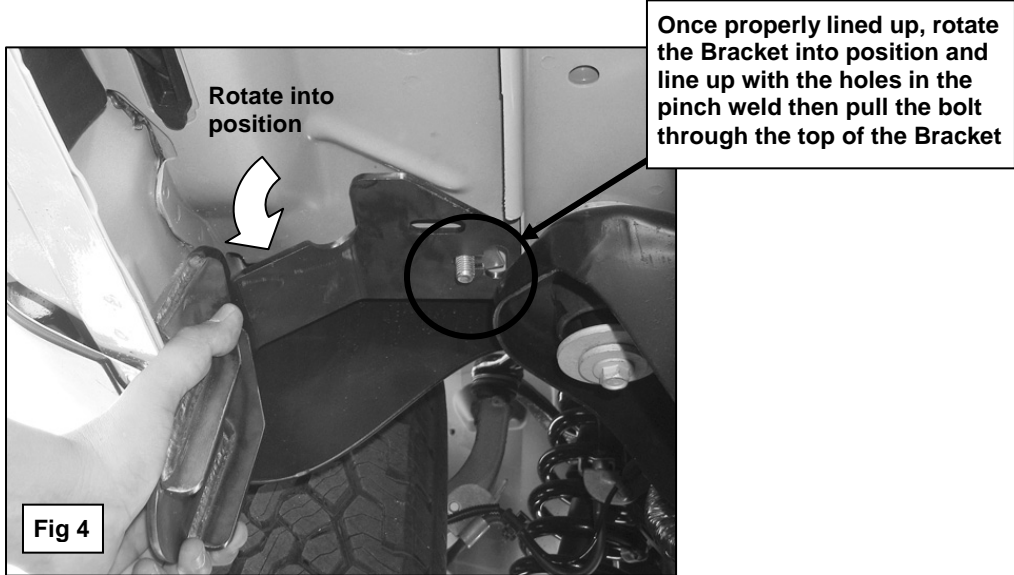

Once properly lined up, rotate the Bracket into position and line up with the holes in the pinch weld then pull the bolt through the top of the Bracket

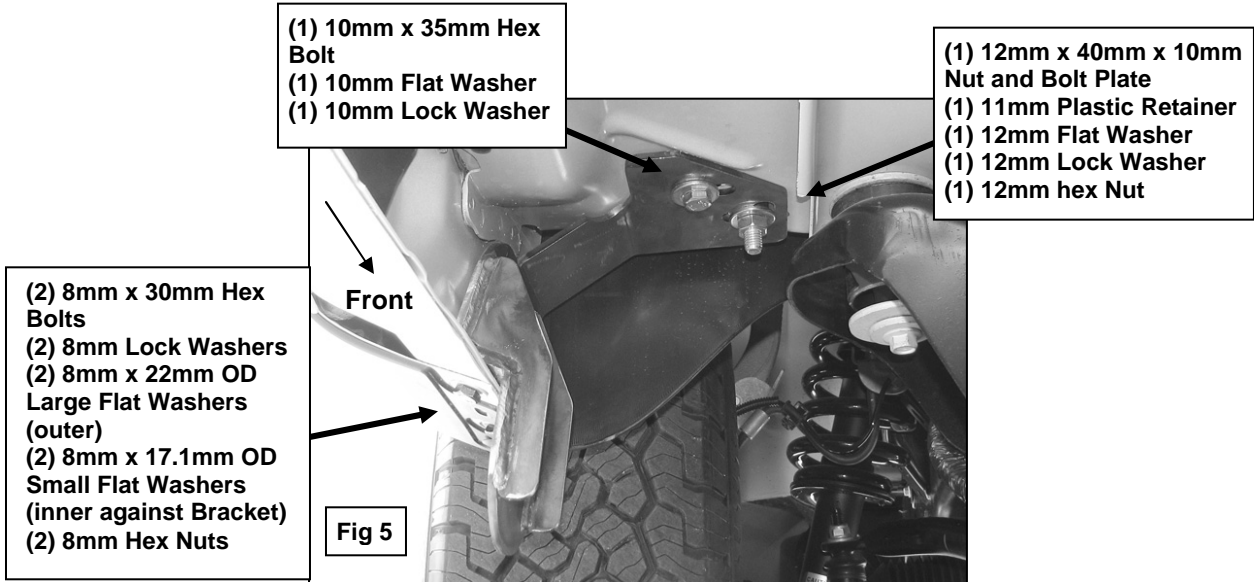

- (1) 10mm x 35mm Hex Bolt
- (1) 10mm Flat Washer
- (1) 10mm Lock Washer

- (1) 12mm x 40mm x 10mm Nut and Bolt Plate
- (1) 11mm Plastic Retainer
- (1) 12mm Flat Washer
- (1) 12mm Lock Washer
- (1) 12mm hex Nut

- (2) 8mm x 30mm Hex Bolts
- (2) 8mm Lock Washers
- (2) 8mm x 22mm OD Large Flat Washers (outer)
- (2) 8mm x 17.1mm OD Small Flat Washers (inner against Bracket)
- (2) 8mm Hex Nuts

For Technical Support/Warranty Information please call 310-762-9944



Installation Instructions
Sure Step
(Part #FN1990-S4B/FN1990-S4S)
09 Ford F-150 Super Crew

Driver Side Installation Pictured

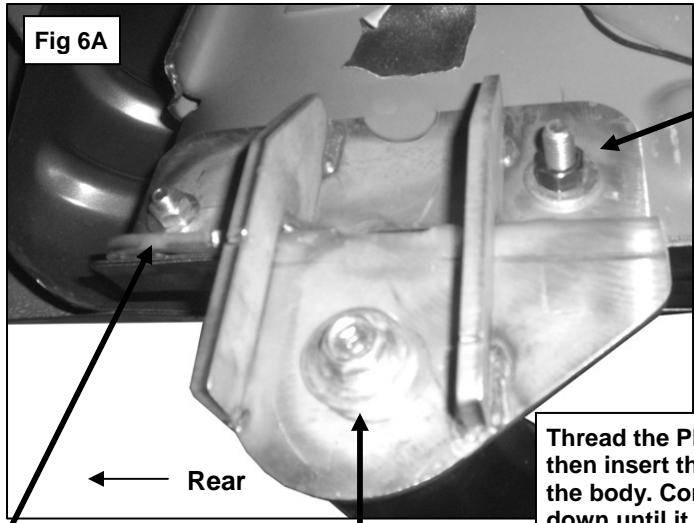

- 12mm Bolt Plate with Plastic Retainer
- 12mm Flat Washer
- 12mm Lock Washer
- 12mm Hex Nut

Thread the Plastic Retainer onto the Bolt Plate then insert the Bolt Plate into the large hole in the body. Continue to thread the Retainer down until it is snug against the body

- 1/2" x 2" Hex Bolts
- 1/2" Lock Washers
- 1/2" Flat Washers

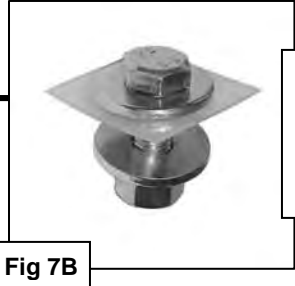
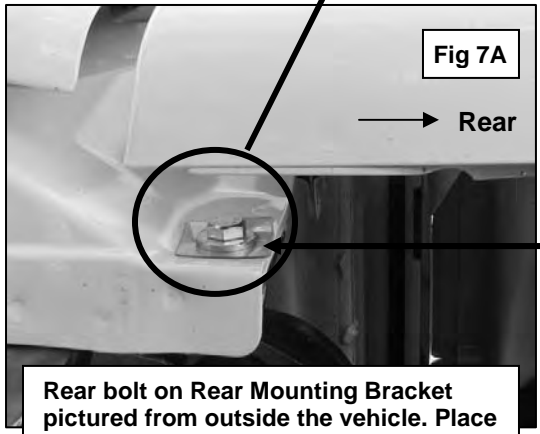

- 10mm x 35mm Hex Bolt with Plastic Retainer
- (2) 10mm Flat Washers
- 10mm Lock Washer
- 10mm Hex Nut

Rear bolt on Rear Mounting Bracket pictured from outside the vehicle. Place the Plastic Washer between the 10mm Flat Washer and the painted surface of the truck body



Complete Installation

For Technical Support/Warranty Information please call 310-762-9944



Installation Instructions
Sure Step
(Part #FN1990-S4B/FN1990-S4S)
09 Ford F-150 Super Crew

Cleaning and Maintenance

To protect your investment, wax this product after installing. Regular waxing is recommended to add a protective layer over the finish. Do not use any type of polish or wax that may contain abrasives that could damage the finish.

For stainless steel: Aluminum polish may be used to polish small scratches and scuffs on the finish. Mild soap, window or glass cleaner may be used also.

For gloss black finishes: Mild soap, window and glass cleaner may be used.

LIMITED WARRANTY

Smittybilt (The Company) warrants to the original purchaser of this product that should the product or any part thereof, under normal use and conditions, be proven defective in material or workmanship within the warranty period of 5 years from the date of purchase, such defect(s) will be repaired or replaced (At the Company's option) without charge for parts or labor. To obtain repair or replacement within the terms of the warranty, the product is to be delivered with proof of warranty coverage (e.g. dated bill of sale, receipt), specification of defect, freight pre-paid with Returns Good Authorization Number from Smittybilt to place of purchase. Items returned to Smittybilt without a Returns Authorization Number will be refused and returned to sender at the senders' expense.

This warranty does not apply to any product or part thereof which, in the opinion of the Company, has suffered or been damaged through altercation, improper installation, mishandling, misuse, neglect accident or acts of nature. **THE EXTENT OF THE COMPANY'S LIABILITY UNDER THIS WARRANTY IS LIMITED TO THE REPAIR OR REPLACEMENT PROVIDED ABOVE AND, IN NO EVENT, SHALL THE COMPANY'S LIABILITY EXCEED THE PURCHASE PRICE PAID BY THE PURCHASER FOR THIS PRODUCT.**

This warranty is in lieu of all expressed warranties and liabilities. ANY IMPLIED WARRANTIES, INCLUDING ANY IMPLIED WARRANTY OF MERCHANTABILITY SHALL BE LIMITED TO THE DURATION OF THIS WRITTEN WARRANTY. ANY ACTION FOR BREACH OF ANY WARRANTY HEREUNDER INCLUDING ANY IMPLIED WARRANTY OF MERCHANTABILITY MUST BE BROUGHT WITHIN A PERIOD OF 90 DAYS FROM DATE OF ORIGINAL PURCHASE. IN NO CASE SHALL THE COMPANY BE LIABLE FOR ANY CONSEQUENTIAL OR INCIDENTAL DAMAGES FOR BREACH OF THIS OR ANY OTHER WARRANTY, EXPRESSED OR IMPLIED, WHATSOEVER. No person or representative is authorized to assume for the company any liability other than expressed herein in connection with the sale of this product. Some states do not allow limitations on how long an implied warranty lasts or the exclusion or limitation of incidental or consequential damage, therefore above limitations may not apply to you. This warranty gives the purchaser specific legal rights. The purchaser may have additional rights, which vary from state to state.

Some states do not allow limitations on how long an implied warranty lasts or the exclusion or limitation of incidental or consequential damage, therefore above limitations may not apply to you. This warranty gives the purchaser specific legal rights. The purchaser may have additional rights, which vary from state to state.

For Technical Support/Warranty Information please call 310-762-9944

Smittybilt, 400 West Artesia Blvd, Compton, CA 90220

Page 6 of 6