



MODEL SPECIFIC GUIDE

Hidden Hinge Version

Model 1140 GMC Sierra Std/Ext/Crew Cab
6.5' Short Bed 2014-Current (will not fit 2014 Sierra 2500hd)



Note: The hardware kit for this truck includes 2 rubber spacers. These rubber spacers are to be placed between the plastic bed rail cap and the bed rail prior to installing the front front brackets. Attach according to the diagram below.

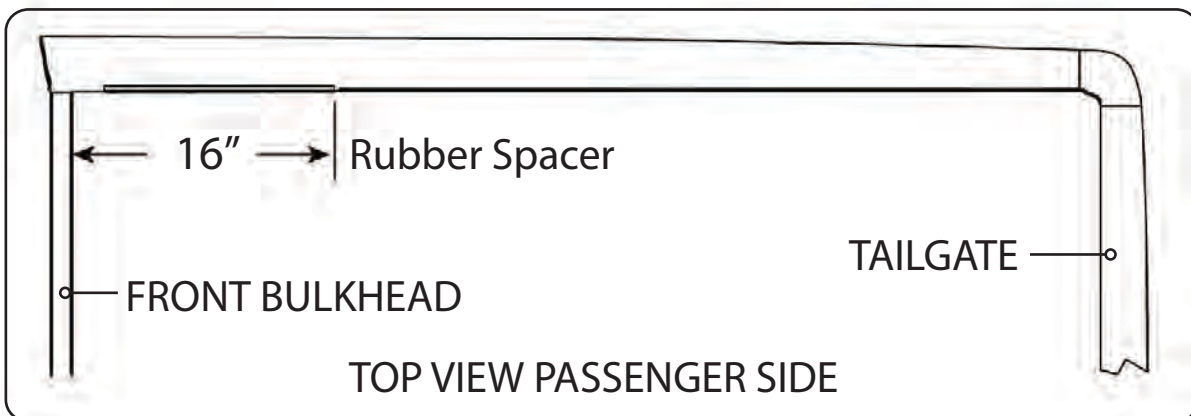

RE: Step 2 on the Quick Start Guide

Measurement for the rear mounting bracket is $52\frac{3}{8}$ " from the back side of the bulkhead to the front edge of the bracket.

TOP VIEW PASSENGER SIDE

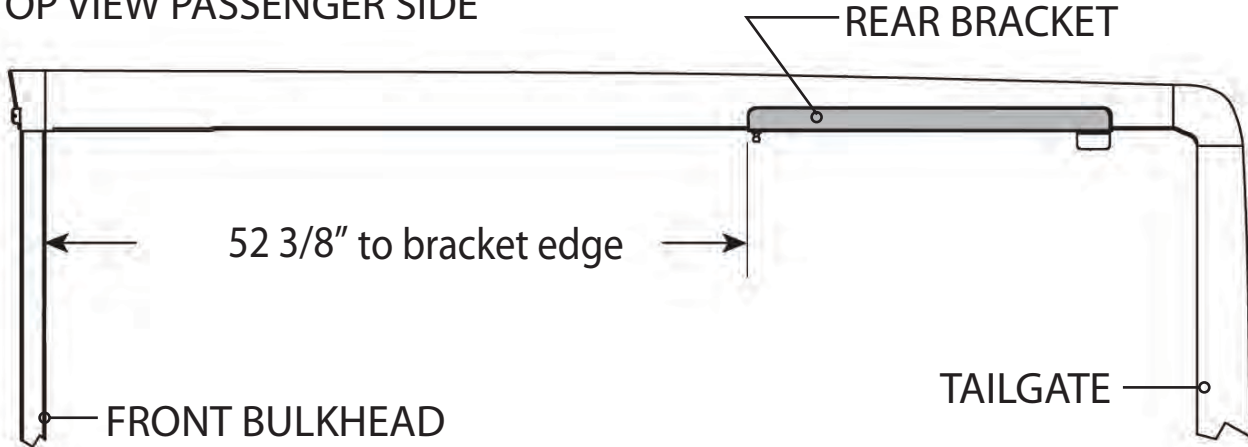

RE: Step 3 on the Quick Start Guide

Measurement for the front mounting bracket is 16 " from the back side of the bulkhead to the end of the bracket.

The fit of the cover to the truck bed is determined by the front mounting brackets. This measurement is a good starting point. Unfortunately not all truck beds are assembled 100% square, so some adjustments may be necessary after the cover is set on the truck.

TOP VIEW PASSENGER SIDE

