



# INSTALLATION INSTRUCTIONS PLOW MOUNTING KIT

Part Number: 70583

Application: Honda Rubicon / Foreman 500

Your safety, and the safety of others, is very important. To help you make informed decisions about safety, we have provided installation and operating instructions and other information on labels and in this guide. This information alerts you to potential hazards that could hurt you or others. It is not possible to warn you about all potential hazards associated with this product, you must use your own good judgment.

**CARELESS INSTALLATION AND OPERATION CAN RESULT IN SERIOUS INJURY OR EQUIPMENT DAMAGE. READ AND UNDERSTAND ALL SAFETY PRECAUTIONS AND OPERATING INSTRUCTIONS BEFORE INSTALLING AND OPERATING THIS PRODUCT.**

This guide identifies potential hazards and has important safety messages that help you and others avoid personal injury or death. **WARNING** and **CAUTION** are signal words that identify the level of hazard. These signal words mean:

**▲WARNING** signals a hazard that *could* cause serious injury or death, if you do not follow recommendations. **▲CAUTION** signals a hazard that *may* cause minor to moderate injury, if you do not follow recommendations.

This guide uses **NOTICE** to call attention to important mechanical information, and **Note**: to emphasize general information worthy of special attention.

## ▲ WARNING

### INJURY HAZARD

Failure to observe these instructions could lead to severe injury or death.

- Always** Read the Plow Operator's Manual, the Winch Operator's Manual and all warning labels before operating.
- Always** use extreme caution when drilling on any vehicle. Make sure that all fuel lines, brake lines, electrical wires, and other objects are not punctured or damaged when/if drilling on the vehicle. Thoroughly inspect the area to be drilled (on both sides of material) prior to drilling, and relocate any objects that may be damaged. Failure to inspect the area to be drilled may result in vehicle damage, electrical shock, fire or personal injury.
- Always** wear safety glasses when installing this kit. A drilling operation will cause flying metal chips. Flying chips can cause eye injury.
- Always** use extreme caution when cutting and trimming during fitting.
- Always** remove jewelry and wear eye protection.
- Never** lean over battery while making connections.
- Never route electrical cables:**
  - Across any sharp edges.
  - Through or near moving parts.
  - Near parts that become hot.
- Always** insulate and protect all exposed wiring and electrical terminals.
- Always** install terminal boots as directed in installation instructions.
- Always** use appropriate and adequate care in lifting components into place.
- Always** insure components will remain secure during installation and operation.
- Always** tighten all nuts and bolts securely, per the installation instructions.
- Always** operate the vehicle at a walking speed with the blade installed. Never exceed 5 mph (8 km/h), even with blade up.
- Always** plow cautiously, impact with hidden or stationary object may cause the vehicle to stop suddenly or go out of control.
- Never** operate the vehicle on slopes greater than 10 degrees with the plow installed.
- Never** stand or ride on the plow.
- Always** stay clear of moving parts and joints. Always keep others away when operating or adjusting plow.
- Always** perform regular inspections and maintenance on the plow mechanism, fasteners, cable and related hardware.
- Always** replace all worn or damaged parts before operating.
- Never** operate this WARN product with damaged or missing parts.
- Always** drive slowly over bumpy and rough terrain. Driving at speeds that cause the plow to bounce while in the up position can cause the winch to back-drive, causing the plow to work its way down. This may result in the plow impacting a stationary object and cause damage to the vehicle and operator injury or death.
- Always** drive at speeds such that the plow does not bounce and be aware of the plow position while driving at all times.
- Always** be aware that the purpose of the j-bolt is to break the connection between the plow and the winch, to prevent serious damage to the ATV if the plow is raised too high. The plow blade will drop suddenly if the j-bolt breaks, so always be sure there are no bystanders when you raise and lower the plow.
- Never** raise the top of the plow above the headlights of the ATV, as it may damage the vehicle and plow.
- Always** replace a deformed or broken j-bolt with the spare j-bolt included in the kit.

<b>⚠ Caution</b>	
<b>Moving Parts Entanglement Hazard</b>	
<b>Failure to observe these instructions could lead to minor or moderate injury.</b>	
<input type="checkbox"/>	<b>Always</b> take time to fully read and understand the installation and Operations Guide included with this product.
<input type="checkbox"/>	<b>Never</b> operate this product if you are under 16 years of age.
<input type="checkbox"/>	<b>Never</b> operate this product when under the influence of drugs, alcohol or medications.
<b>Read installation and operating instructions thoroughly.</b>	

<b>Notice</b>	
<b>Equipment Damage</b>	
<input type="checkbox"/>	<b>Always</b> refer to the Installation and Specification Guide, supplied in the winch kit, for all wiring schematics and specific details on how to wire this WARN product to your vehicle.
<input type="checkbox"/>	<b>Never</b> overtighten the j-bolt to the bracket. Doing so will pinch the winch cable against the bracket, damaging the cable.
<input type="checkbox"/>	<b>Always</b> put the end of the actuator cable through the slot in the Termination Bracket. Terminating the cable through any other hole in the bracket will cause the bracket to not function properly and will drastically reduce the life of the actuator cable.
<b>Read installation and operating instructions thoroughly.</b>	

**Note:**

*Please refer to the Winch and Lowering Plow Instructions, p 5-6, if you plan to lower your plow using a winch.*

**I. TABLE OF CONTENTS**

Parts List	page 2
Tools Required	page 2
Installation	page 3-4
Winch and Lowering Plow Instructions	page 5-6
Maintenance/Care	page 7

**II. PARTS LIST**

<i>Ref</i>	<i>Part #</i>	<i>Description</i>	<i>Qty</i>
A1	70820	Plow Mount	1
B1	60868	5/16-18 x 1-1/8" x 1-3/4" u-bolt	1
B2	60869	5/16-18 x 1-3/8" x 2" u-bolt	2
B3	1324	5/16" Flat Washer	6
B4	2002	5/16-18 Lock Nut	6

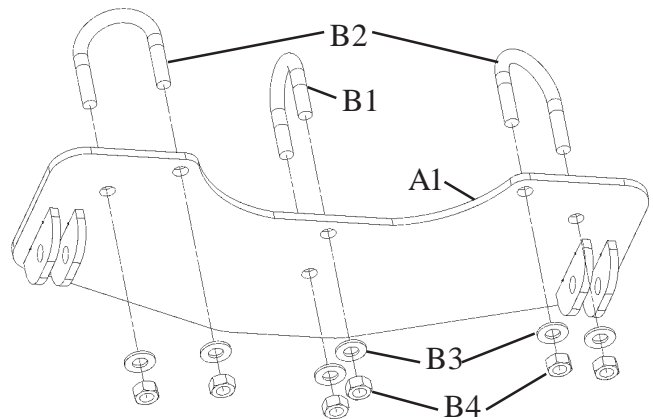

**III. TOOLS REQUIRED**

- Ratchet
- 10mm Socket
- 13mm Socket
- 1/2" Socket
- Side Cutting Pliers

## IV. INSTALLATION

1. Remove the four skid plate bolts, and remove the skid plate from the vehicle, Figure 1.

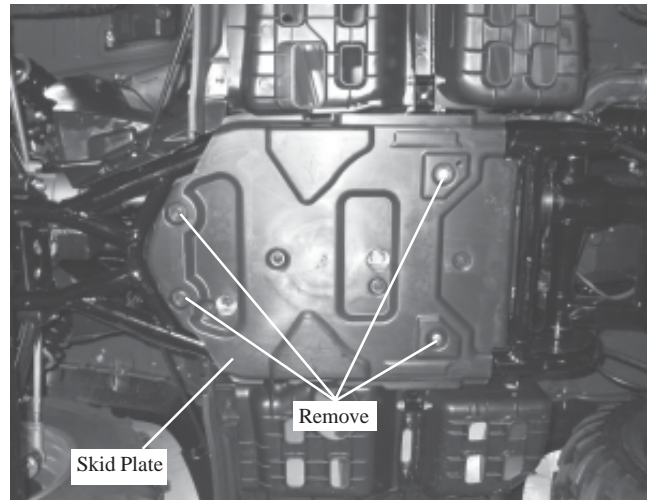

**Figure 1**

2. Remove approximately a 1.0" by 0.5" piece from both sides of the skid plate using side cutting pliers or snips, Figure 2.

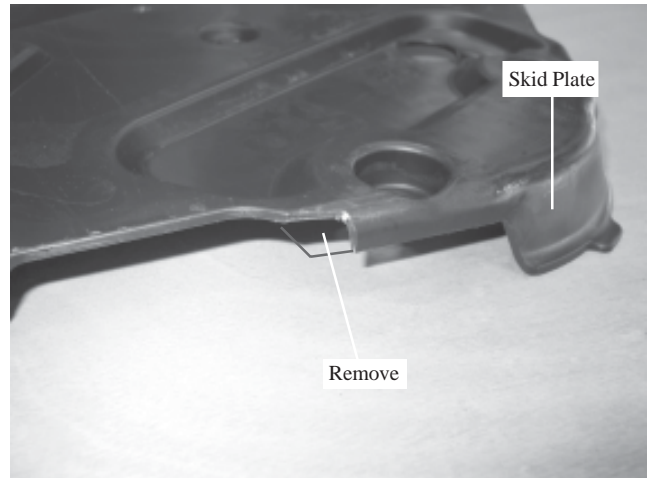

**Figure 2**

### **INSTALLATION CONT.**

3. Place the u-bolts (B1 & B2) around the vehicle frame, Figure 3. The front of the skid plate must be pushed upward in order to slide the u-bolt (B1) around the frame member. Additional skid plate trimming may be necessary if there is contact with the side u-bolts (B2).

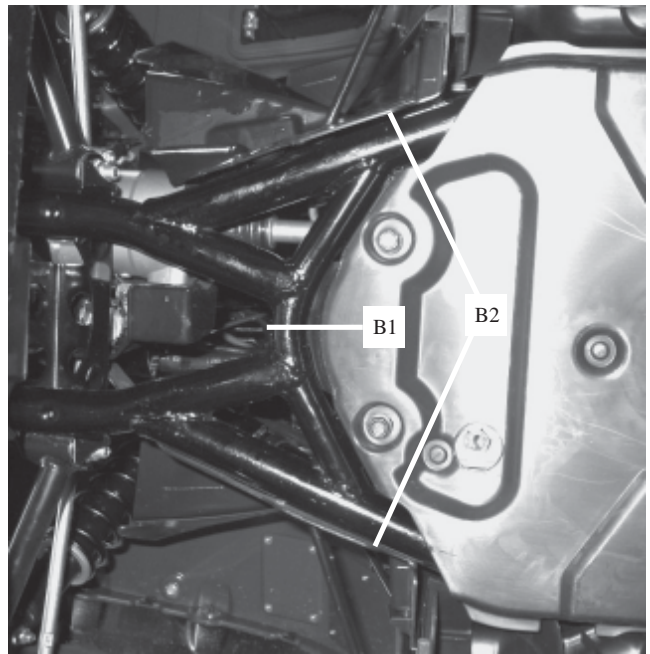

**Figure 3**

4. Fasten the plow mount (A1) to the vehicle with the u-bolts (B1 & B2), flat washers (B3), and lock nuts (B4), Figure 4. Align the plow mount with the vehicle. Tighten the u-bolts uniformly to 10lb-ft (14 N-m).

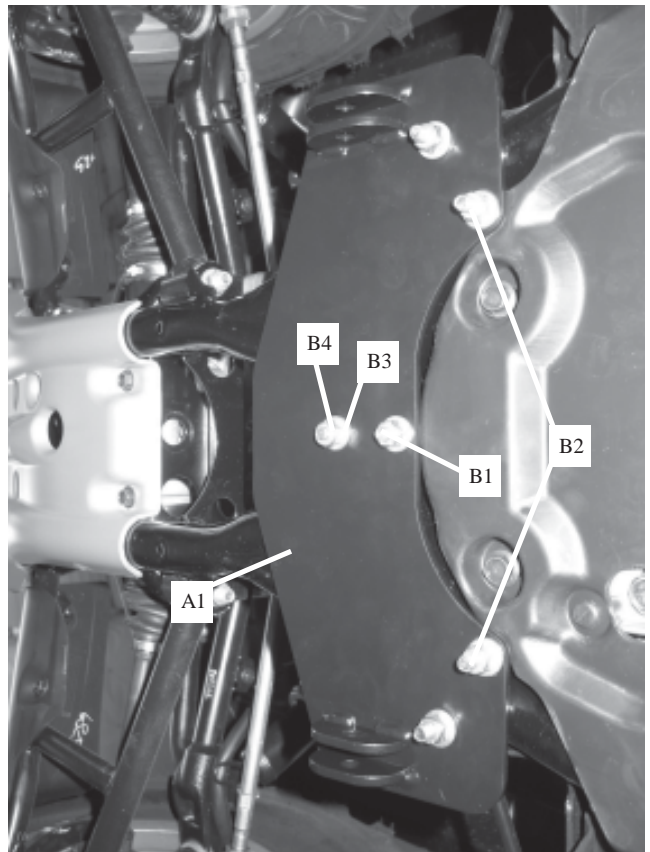

**Figure 4**

## WINCH AND LOWERING PLOW INSTRUCTIONS:

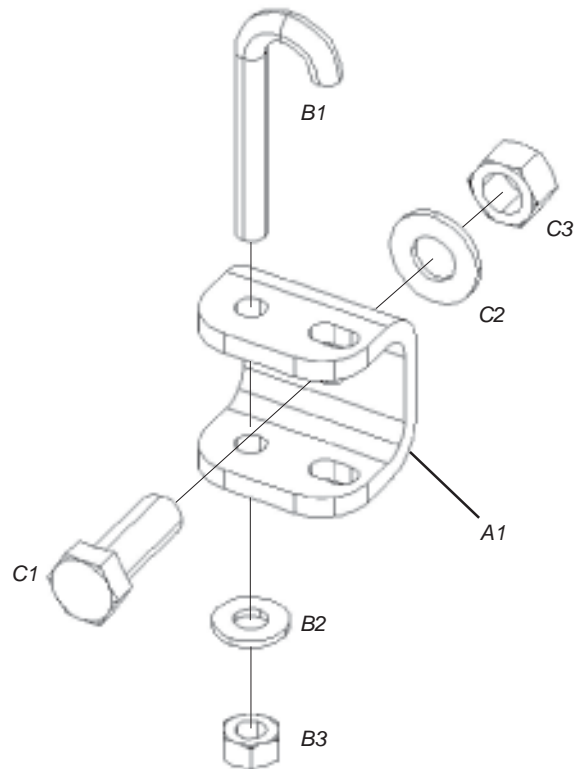

### A. Parts List

<u>Ref</u>	<u>Part #</u>	<u>Description</u>
A1	62845	J-bolt Bracket
B1	35391	1/4" dia J-bolt
B2	1320	1/4" dia flat washer
B3	6725	1/4" dia nylock nut
C1	1827	3/8" dia x 1" long bolt
C2	11524	3/8" flat washer
C3	6779	3/8" nylock nut

### B. Tools Required

<u>Qty</u>	
1	• Ratchet
1	• Sockets: 7/16", 9/16"
2	• Wrenches: 9/16"

## C. Installation

1. Attach the J-bolt bracket (A1) to the center hole in the plow crossmember using a 3/8" dia x 1" long bolt (C1) as shown in figure 1. The bracket should be mounted on the blade side of the crossmember with the side flanges parallel to the ground. Terminate the bolt with a 3/8" dia flat washer (C2) and 3/8" dia nylock nut (C3). Tighten the bolt and nut to a recommended torque of 20 ft-lb (28 N-m).
2. Run the winch cable over the roller fairlead and down to the J-bolt bracket (A1). Using a 1/4" dia J-bolt (B1), hook the loop on the end of the winch cable and slide the threaded end of the J-bolt through the round holes in the J-bolt bracket. The hook end of the J-bolt should slide into the slotted hole in the J-bolt bracket. Terminate the end of the J-bolt with a 1/4" dia flat washer (B2) and 1/4" dia nylock nut (B3). Tighten the nut until the winch cable is snug inside the J-bolt as shown in figure 2.

*NOTE: Do not remove the winch hook installed on the end of the winch cable, simply slide it out of the way.*

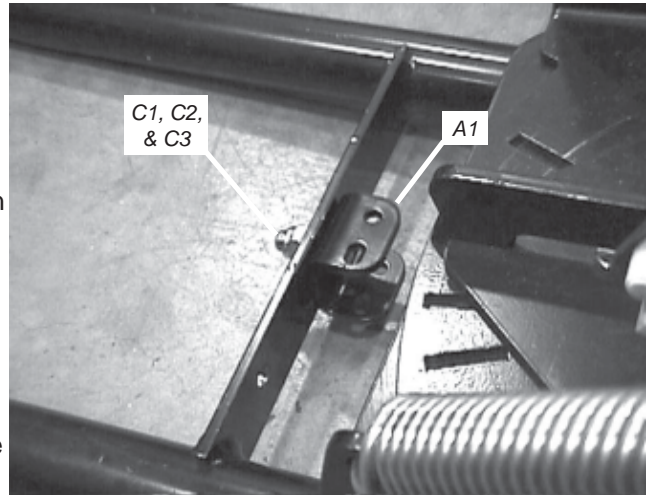

Figure 1 Installed J-bolt Bracket

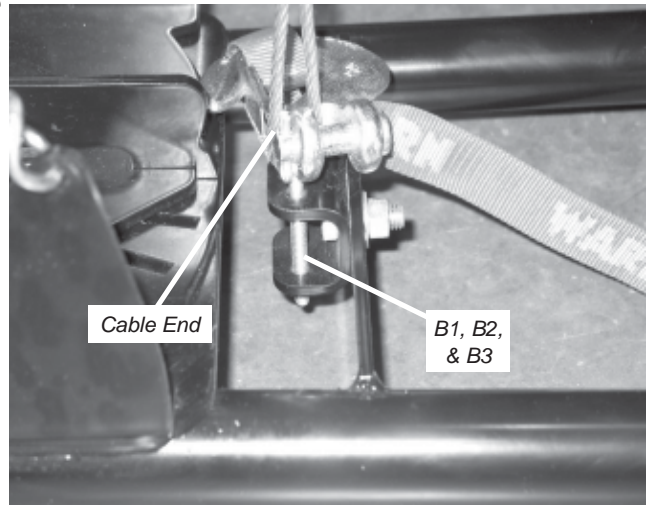

Figure 2 J-bolt and Winch Cable

### **⚠ CAUTION**

The purpose of the J-bolt is to break the connection between the plow and ATV when the plow is subjected to high forces that could damage the plow or vehicle. The plow will drop instantly if the J-bolt breaks, so be sure there are no bystanders when operating the plow. Instances when the J-bolt might break are:

- If the plow is raised too high and stalls.
- If the operator is trying to lift too much material with the plow blade.

In general, do not raise the top of the plow blade above the headlights of the vehicle. If the plow stalls, stop the winch immediately and lower the plow. After pushing material with the plow, backup the ATV prior to raising it. If the J-bolt breaks, replace it with the spare hardware found in this kit. Read the Plow Operators Guide for more information.

Installation is now complete. Proceed to the next section entitled Maintenance/Care.

## **V. MAINTENANCE/CARE**

- Inspect all metal parts on the plow, plow mount, and related hardware. Replace all parts that appears rusted or deformed prior to use.
- Inspect all nuts and bolts on the plow, plow mount, and related hardware prior to each use. Tighten all nuts and bolts that appear to be loose. Stripped, fractured, or bent bolts or nuts need to be replaced immediately.
- Check all cables prior to use. Replace cables that are worn or frayed.
- Check all moving and rotating parts. Remove debris that may inhibit the part from moving freely.