

Kit Details

27673



HARDWARE LIST

Part #	Description	Qty
72605	4pt Fast Air Manifold - 1/4"	1
27042	Gen 3 Display	1
26498-002	Electrical Harness - FastAir	1
20946	DOT 1/4" Air Line	60ft
24672	Fuse, spade 3amp	1
24547	Fuse, spade, 30amp	1
24500	ATC Fuse holder w/ cap	2
24645	16GA Butt Connector	1
24752	12-10GA Butt Connector	3
24748	12GA Ring Terminal 3/8"	2
24524	Female Spade Terminal	1
24595	12GA Female Spade Terminal	1
24561	Adaptor, Mini Fuse	1
24542	ATC/ATO Fuse Adaptor	1
17263	1/4-14 X 1 Heavy Duty Washer	3
10466	8" Zip Tie	10



Missing or damaged parts? Call Air Lift customer service at (800) 248-0892 for a replacement part.



AutoPilot V2™

PATENT PENDING



- *Calibrate to your vehicle* page 7
- *Automatic preset maintenance*..... page 7
- *Rise on start*..... page 8
- *8 programmable presets* page 8
- *Micro adjust to ± 1 PSI*..... page 12
- *Manual mode with Easy Control™ Tap* page 12



View AutoPilotV2™ videos at:
www.airliftperformance.com/video/

INSTALLATION GUIDE

For maximum effectiveness and safety, please read these instructions completely before proceeding with installation.

Failure to read these instructions can result in an incorrect installation.



TABLE OF CONTENTS



Installing the AutoPilot V2 Kit	4
NPT Assembly Instructions	6
Air Line and Fittings Helpful Hints.	6
Setup and Calibration	7
Program Presets	8
Troubleshooting Guide.	9
Leak Testing and Detection	9
Use the System	12
Electrical Schematic	13
Warranty and Returns Policy	14
Replacement Information	14
Contact Information	14
Manifold Template.	15
AutoPilot V2 Remote Control Unit	17
16380 Compressor Template	19



Installing the AutoPilot V2 Kit

INSTALL COMPONENTS (For a complete schematic please see fig. 14, pages 10-11)

- 1. Layout** Plan component location first. Prior to mounting components, check to make sure the electrical harness connections will reach the manifold and compressor, the compressor leader hose will reach the tank, and the plumbing will route cleanly through the vehicle.

NOTE: Be sure to install all components as far as possible from any heat sources. Plan and prepare harness and plumbing routing thru the vehicle. Eliminate all sharp edges that could chafe. Use grommets when passing through compartment walls.

- 2. Prepare and install compressor**

- Prepare compressor intake. If inside vehicle, attach filter to port on end of compressor (Fig. 14). If compressor located outside vehicle, snorkel inlet filter to dry location inside vehicle.
- Center punch and drill four holes using the template on page 19.
- Attach using hardware supplied with compressor.

VIAIR	Max. Tank Pressure
380C	175
400C	150
444C	175
450C	150
480C	175

NOTE: If harness must be lengthened, use properly sized butt connectors and wire. If extending power/ground wires, use 8AWG wire minimum or contact Air Lift for more information.

NOTE: Supplied harness is only capable of powering a single compressor. If installing dual compressors, a second dedicated power wire is required. Consult page 13 for proper wiring, and contact Air Lift for an optional second compressor harness (part number: 27679).

Manifold

- Locate manifold above compressors and tank if possible to avoid compressor ingested water from gathering in manifold.

NOTE: Do not mount manifold upside down.

- Position manifold in desired location: make sure manifold mount surface is flat.
- Fasten using the two self-tapping screws. **If mounting surface is not flat, add washers to space the manifold up over surface irregularities.**

Tank pre assembly (see fig. 14)

NOTE: Air compressors ingest moisture and will deposit water in the tank. Tanks must be regularly purged – be sure to provide easy access to drain/fill valve (preferably outside the vehicle). The AutoPilot V2 system does not include moisture separators or water traps, and does require periodic tank moisture drain. If using an engine driven compressor, proper oil and water filtration must be added as these compressors will contaminate the air suspension system. Water traps are available and sold separately through Air Lift Performance (part numbers: 1/4" - 21011, 3/8" - 21012, 1/2" - 21013)

- Apply thread sealant as necessary.
- Determine tank location and orientation prior to installing fittings.
- In the lower most tank threaded port, install drain/fill PTC fitting.
- Choose a tank threaded port for the compressor fitting.
- Choose the highest tank threaded port for manifold airline routing.
- Plug the remaining tank ports with hex plugs.

Tank install (see fig. 14)

- Use tank feet as template, drill holes for hardware assembly.
- Attach tank using supplied hardware.
- Cut appropriate length of hose from the manifold port 5, to the PTC fitting on tank.
- Route drain/fill air line with schrader valve (preferably outside vehicle).
- Mount fitting on bottom tank port.

NOTE: Use a standard hose cutter (Air Lift part number 10530) or razorblade. Cut all hose ends square and as smoothly as possible.

INSTALL HARNESS

1. Disconnect battery ground while installing system.

2. Compressor / manifold connections (see fig. 14)

- Attach the manifold connector, it will “click” into place once fully seated.
- Mount the compressor relay in a preferred location using a self-tapping screw.
- Cut off the spade and eyelet from the compressor power and ground wires.
- Strip ¼” of wire casing from the compressor wires.
- Strip ¼” of wire casing from the black and pink harness wires.

NOTE: Use an appropriate terminal crimp tool to ensure a good connection.

- Using butt connector attach the RED compressor wire to the PINK harness wire.
- Using butt connector attach the BLACK compressor wire to the BLACK harness wire.
- Carefully apply heat (preferably with a heat gun) to seal these connections.

3. Battery / ignition connections (see fig. 14)

- Identify the power, ground, + ignition leg of the harness.
 - Ground: 10AWG black wire; Power: 10AWG red wire; Ignition: 18AWG pink wire.
- Route power and ground leg of the harness free from any heat source to the battery.
- Using butt connector attach red wire to fuse holder.
- Attach 3/8” eyelet to the other end of the fuse holder and attach to positive battery (+) terminal.
- Attach 3/8” eyelet to the black wire and attach to battery ground.
- Route the 18AWG pink wire to a key switched IGNITION source that remains on during cranking. Examples include: ECU, fuel pump. Do not select an accessory source. If the AutoPilot V2 display shuts off while starting vehicle this is not a true ignition source.
- Using butt connector attach the pink ignition wire to a fuse holder.
- Select ignition source and attach the fused ignition wire.
- Use fuse adaptors as necessary.

4. Display

- Route display cable as desired to the preferred operating location.
- Attach the display cable to the main harness cable (small white 3 cavity connector).

5. Reconnect battery

INSTALL AIR LINES

NOTE: Use a standard hose cutter (Air Lift part number 10530) or razorblade. Cut all hose ends square and as smoothly as possible.

Route and attach air lines to air springs

- Route air lines free from abrasive edges and heat sources.
- Attach manifold port **FL** or **1** to the front, drivers side left spring.
- Attach manifold port **FR** or **2** to the front, passengers side right spring.
- Attach manifold port **RL** or **3** to the rear, drivers side left spring.
- Attach manifold port **RR** or **4** to the rear, passengers side right spring.
- Attach manifold port **T** or **5** to the PTC fitting previously installed on the tank.
- Manifold port **E** or **6** is the exhaust port.
 - Port E can be left open, or routed to a preferred exhaust location.

NOTE: Air lines should be pushed in firmly, with a slight back and forth rotational twist – check the connection by pulling on each line to verify a robust connection.

NOTE: Release the air line from the fitting by releasing air, pushing on the line, depressing the ring towards the fitting, and then pulling the hose out of the fitting.

NPT Assembly Instructions

1. Inspect port and fitting to ensure both are free of contaminants and excessive burrs and nicks.
2. Apply a stripe of liquid pipe sealant around the male threads leaving the first two threads uncovered.
3. Screw finger tight into the port.
4. Wrench tighten the fitting to the correct turns past finger tight position (see table 1).

CAUTION: NEVER BACK OFF AN INSTALLED PIPE FITTING TO ACHIEVE PROPER ALIGNMENT. LOOSENING INSTALLED PIPE FITTINGS WILL CORRUPT THE SEAL AND CONTRIBUTE TO LEAKAGE AND FAILURE.

Torque Specifications			
Fitting Size	Dash Size	Turns Past Finger Tight	Torque lb/ft
1/8" NPT	-02	1.5 - 3.0	12
1/4" NPT	-04	1.5 - 3.0	25
3/8" NPT	-06	1.5 - 3.0	40
1/2" NPT	-08	1.5 - 3.0	54
3/4" NPT	-12	1.5 - 3.0	78
1" NPT	-16	1 - 2.5	112
1 1/4" NPT	-20	1 - 2.5	154
1 1/2" NPT	-24	1 - 2.5	211
2" NPT	-32	1 - 2.5	300

Table 1

Air Line and Fittings Helpful Tips

Hose bend radius

- 3/8" hose = 1.5" hose bend radius
- 1/4" hose = 1" hose bend radius

Hose to fitting

- No side loading on fitting from hose.
- Hose straight for 1" before bending.

Hose cutting

- Cut hose perpendicular to hose length.
- Inspect hose for scratches that run lengthwise on hose prior to insertion.
- Use proper hose cutter, cigar cutter, or razor on flat surface.

DOT/SAEJ844 air brake hose data

- Maximum working pressure of 175 PSI.
- Not to be used for frame (body) to un-sprung mass connection, use a braided leader hose for this moving connection.

Setup and Calibration

AutoPilot V2 is an advanced pressure-based air suspension control system, that uses state-of-the-art software algorithms to calibrate or map the control system to your vehicle. Once the system is calibrated, the algorithm predicts required “valve open time” to move the air suspension to achieve preset target pressures. AutoPilot V2 has 8 programmable presets, allowing the user to input 8 different combinations of the 4 corner air spring pressures.

After installing AutoPilot V2 in your vehicle, please follow the steps below to properly setup your new system! If changes are made after installing and calibrating the system such as changes to air springs, lines, tank, compressor, or other vehicle modifications the system must be recalibrated.

SYSTEM CALIBRATION AND SETTINGS

1. Key-on/power up, and compressor should come on to fill the tank. Check to make sure system is triggered by IGNITION source. While starting the engine, the system should be ON. If not, please refer back to “Install Harness” on page 5.
2. Press buttons 1 and 5 at the same time (1+5) and hold for 5-10 seconds until settings and diagnostics mode main page appears (fig. 2).
3. Press button 1 (TANK ADJUST). Set tank pressure preference by pressing MIN and MAX up/down buttons (fig. 3). Press buttons 1+5 to exit to settings and diagnostics mode.

NOTE: If tank MAX settings are changed, a system re-calibration is necessary for optimal performance.

Calibrate to your vehicle

NOTE: System will automatically deflate to 0 PSI and inflate to 100 PSI during calibration.

4. Press button 2 to enter CALIBRATE (fig. 4). Press SYSTEM CAL (button 1), follow instructions to calibrate AutoPilot V2 system to your vehicle. Once calibration is complete, Press buttons 1+5 to exit to the settings and diagnostics mode.
5. Press button 3 to enter BACKLIGHT (fig. 5). Set display backlight to your preference by pressing the + and – on R (Red), G (Green), B (Blue). Press buttons 1+5 to exit to the settings and diagnostics mode.

Automatic preset maintenance

6. Press button 4 to enter PRESET MAINTAIN (fig. 6). Press button 8 to turn ON or OFF. When ON, this function actively monitors air spring pressure and will fill to maintain active preset pressure.

NOTE: This function will not exhaust pressure. If air spring pressure is higher than preset target, only the operator pressing the preset button again will activate the system to exhaust air spring pressure (for safety). Press buttons 1+5 to exit.

NOTE: PRESET MAINTAIN should be off for performance/ track driving or if operating in extremely hilly areas.

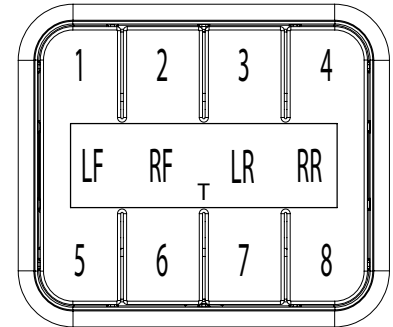

fig. 1

Button Definition

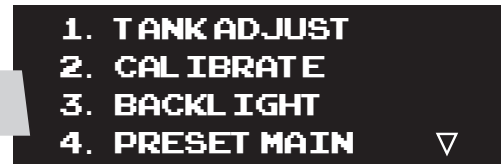

fig. 2



fig. 3

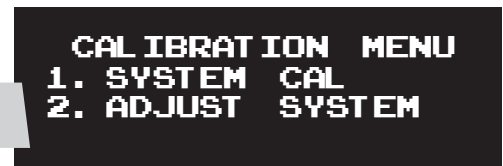

fig. 4

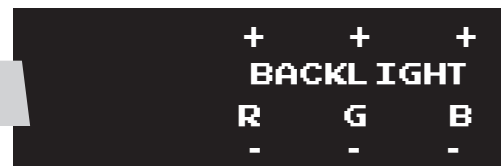
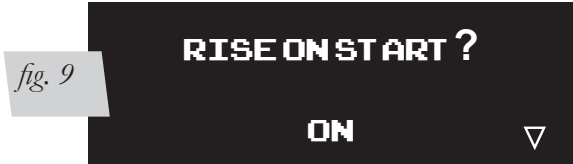
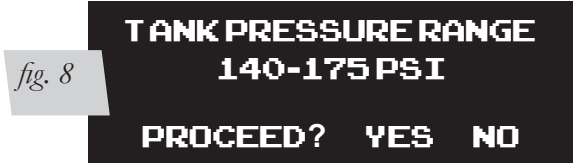
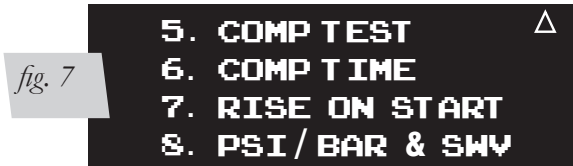

fig. 5



fig. 6

7. Press button 8 to toggle to settings page 2 (fig. 7).
8. Press button 5 to run a compressor test (fig. 8). This function will exhaust the tank to your specified MIN tank pressure, then turn ON the compressor and measure its inflate time to achieve MAX pressure. AutoPilot V2 will record this fill time, allowing the operator to compare future fill times to determine compressor performance. Press buttons 1+5 to exit.
9. Press button 6 to view the number of hours the compressor has been running.



Rise on start

10. Press button 7 to enter RISE ON START (fig. 9). This function will automatically activate valves to achieve preset 1 target pressures when the vehicle is keyed-on. This function allows the operator to drive away seconds after vehicle is started. Press buttons 1+5 to exit.
11. Press button 8 to toggle between PSI and BAR pressure units and check software version. Press buttons 1+5 to exit.
NOTE: BAR stands for DeciBar values.
12. Press buttons 1+5 to exit settings and diagnostics – you are now ready to create presets!

Program Presets

NOTE: Preset 1 should always be entered as the desired ride pressure for the RISE ON START function.

1. Determine ride pressures: press buttons 1+5 to toggle display to MANUAL mode. Manually activate each corner (see MANUAL mode section page 12) to achieve desired “normal driving” ride pressure. (fig. 10)

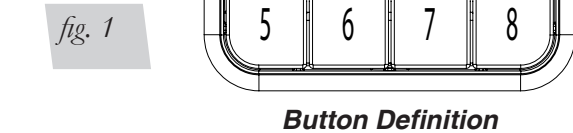

8 programmable presets

2. Program preset 1: press buttons 1+5 to toggle display to PRESET mode. Press and hold button 1 to set 1. Release button and actual air spring pressures will appear (fig. 11). Fine-tune the pressures by pressing up/down buttons. Press + hold to scroll. Press buttons 1+5 to exit.



NOTE: If your system is not hitting presets quickly, change the “ADJ” value. Enter “Settings and Diagnostics” mode (press Button 1+5 for more than 5 seconds), press #2 CALIBRATE, then ADJUST SYSTEM to toggle the value between 0 and 10; higher values increase system fill rates to overshoot target pressures.



3. You are now free to program the additional 7 presets to desired pressures. Typical presets can be:
 - “Low”: set pressures to the lowest possible pressures for extreme low driving stance
 - “Front up”: for speed bump or driveway clearance
 - “Rear up”: for added load of passengers, equipment
 - “Play”: for those that want to enjoy their air suspension



freedom, AutoPilot V2 has a special function that recognizes side-to-side presets. When left side pressures are equal, and right side pressures are equal but >25PSI different than left, the algorithm will activate side to side instead of front to back. It will also equalize all air spring pressures when exiting the “play” preset, conserving air by using the high pressure side to inflate the low pressure side. Pairing two “play” presets together allows side-to-side activation that consumes far less air than manual mode activation would consume (Figs. 12 & 13).

fig. 13



Troubleshooting Guide

For further technical assistance please contact our customer service department by calling (800) 248-0892, Monday through Friday. For calls from outside the USA or Canada, our local number is (517) 322-2144.

PROBLEM	CAUSE	SOLUTION
<i>Compressor doesn't run.</i>	There is a blown fuse or relay, bad ground, or poor electrical connections.	Replace the fuse, check the ground wire, or check the compressor connector.
<i>Compressor runs all the time.</i>	The compressor relay is defective or there is a leak.	Replace the relay or locate the leak and repair.
<i>Air spring or tank leak.</i>	Fitting seal or air line compromised.	Check to make sure air lines are seated in connectors. Inspect fittings with soapy water. Trim hose or re-seal fitting.
<i>Nothing happens when the vehicle is key-on ignition active.</i>	There is a blown fuse or a poor connection.	Replace the fuses and check the electrical connections.
<i>The display does not light up.</i>	There is a blown fuse or a poor connection.	Replace the fuses and check the electrical connections.
<i>Compressor runs all the time but doesn't fill the tank.</i>	Compressor inline check valve fitting has been overtightened.	Loosen fitting and check again. Replace if needed.
Display shows UNSUCCESSFUL	Calibration may need to be adjusted or system may need to be recalibrated .	Adjust ADJ value or recalibrate system to reduce number of iterations.
	Tank pressure settings changed.	
	Vehicle load changed significantly.	Attempt recalibration.
	Air springs/air lines/tank changed.	

Leak Testing and Detection

Leak detection

1. Pressure change is directly proportional to temperature change in a container that is not leaking.
 - a. For every 10° Fahrenheit decrease the pressure by 2 PSI.
 - b. All other pressure changes are due to air exiting the system.
2. Spray soapy water on suspect fittings and hose connections.
3. Wipe down with rag to clean.
4. Soapy water recipe
 - a. 1/5 Dawn brand dish soap to 4/5 water.
 - b. Dawn brand dish soap will not corrode the metals (aluminum, brass, steel) it comes in contact with.

DOT/SAEJ844 hoses and fittings (industry standard)

1. Allowable leak rate < 7 sccm @ -40° (per fitting)
2. Examples
 - a. 150 PSI in a 2.5 gallon tank @ -40° for 12 hours = 142.17 PSI
 - b. 150 PSI in a 5 gallon tank @ -40° for 12 hours = 146.08 PSI
 - c. 100 PSI in a 141 in³ (cubic inches) spring @ -40° for 12 hours = 67.94 PSI
 - Assumption is that the spring keeps constant volume

fig. 14

Connect direct to battery

Preferred

NOTE: If not run to battery, voltage drop may reduce system performance and durability.

Ignition Source (on while cranking)

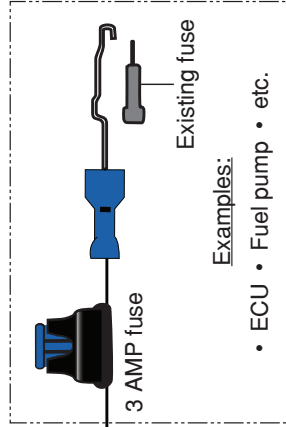

Relay schematic reference

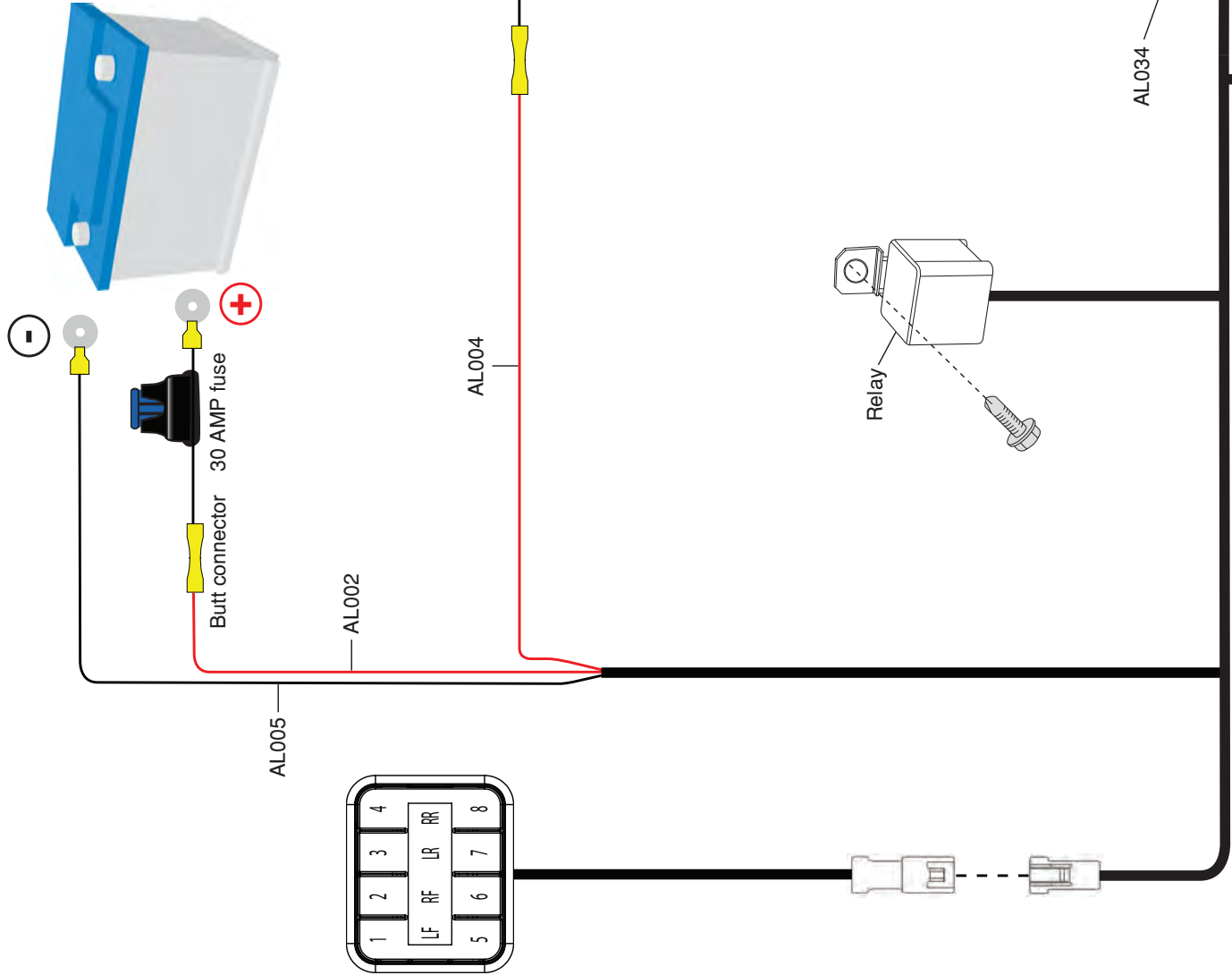
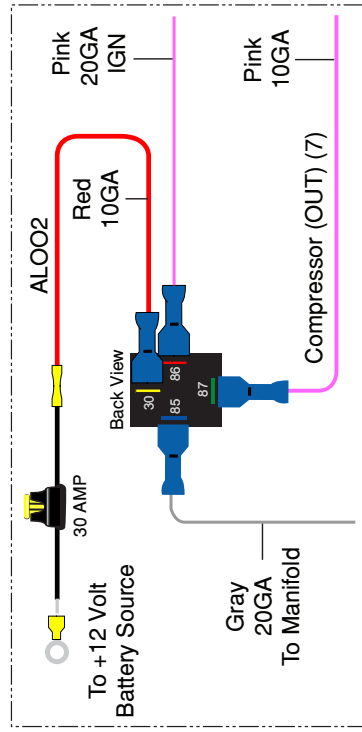

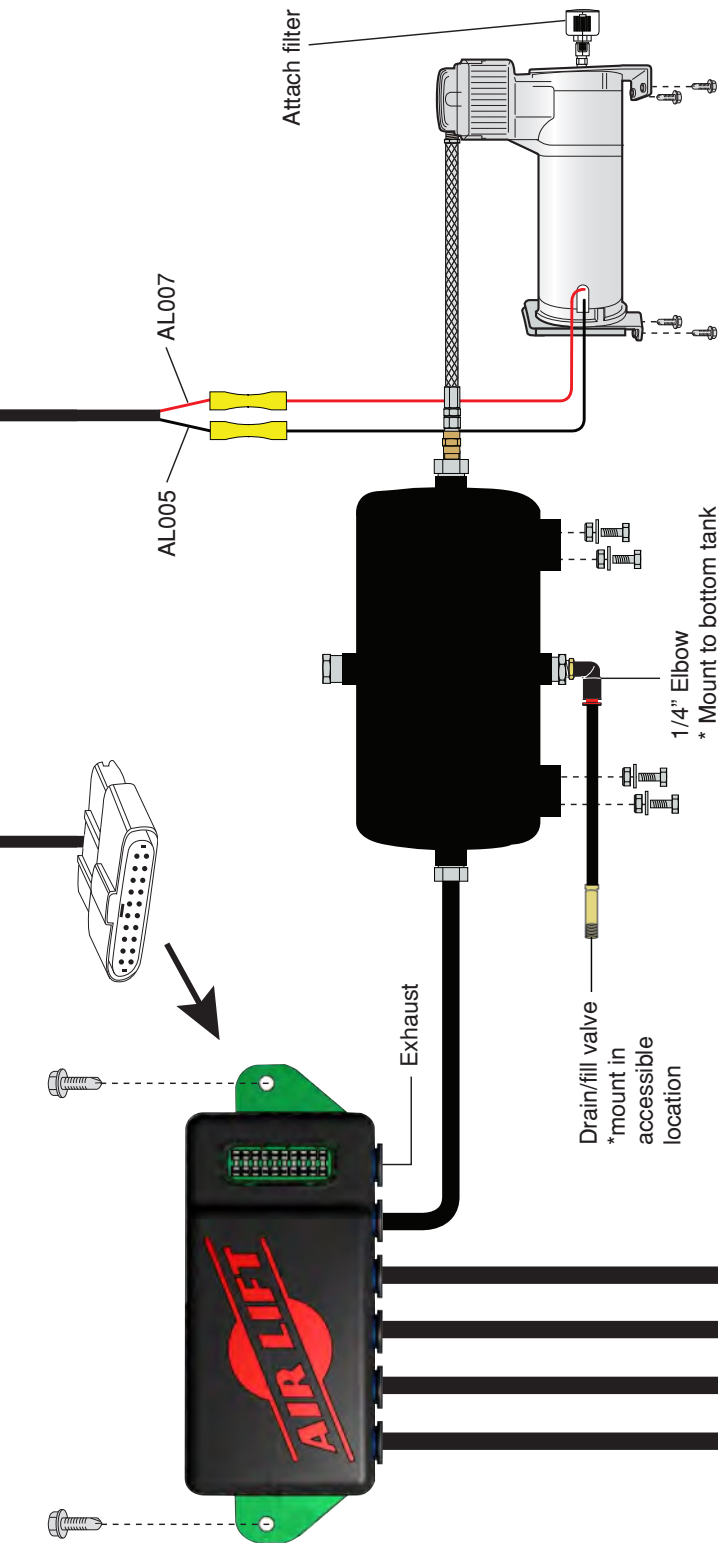

NOTE: Air Lift recommends using a hose cutting tool to ensure a proper cut (Air Lift part number 10530).
 If a hose connection has been disconnected the hose must be trimmed 1/2" back to provide for a leak free seal.

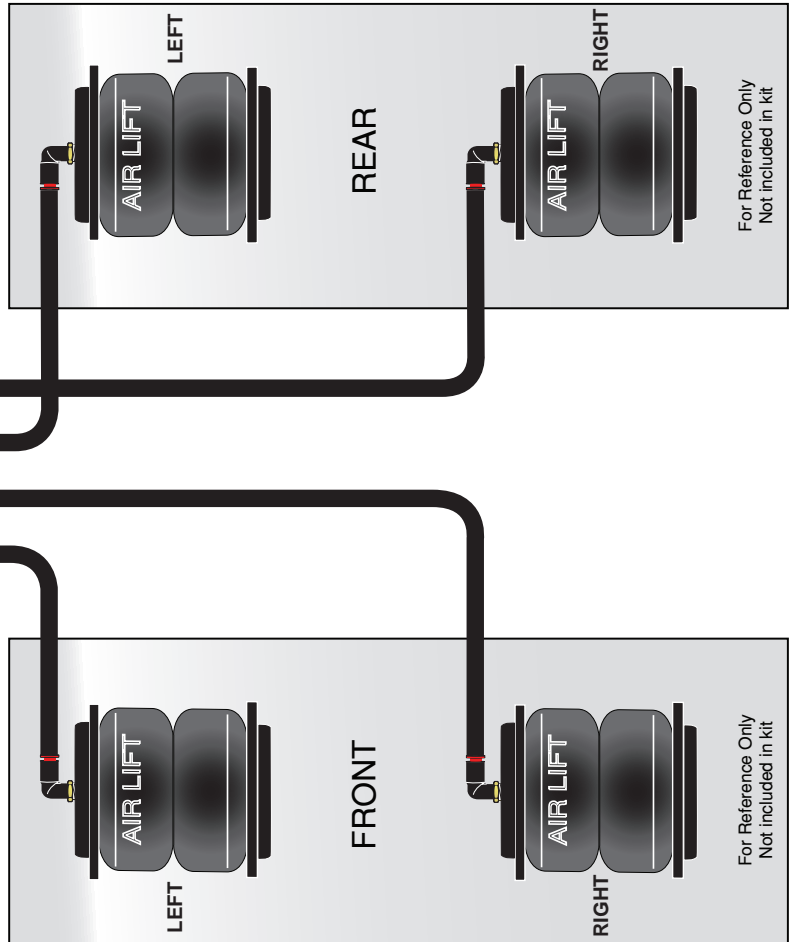

Use the System

Now that your system is set up, it's time to use it. If changes are made after installing and calibrating the system such as changes to air springs, lines, tank, or compressor the system must be recalibrated.

There are two modes: PRESET and MANUAL. Pressing buttons 1 and 5 together will toggle between modes. After 10 seconds of non-use, the display enters standby where the LCD dims. Any button hit will “wake-up” the display and allow users to activate the system. See mode operation below for more details.

PRESET mode

- First button press will display the programmed preset. Users can quickly view each preset prior to activating to make sure they are selecting the desired preset.
- A 2nd button press of the same preset will activate it. The system will iterate up to 6 times to achieve the preset target pressures by +/- 3 PSI. Display shows PLEASE WAIT as it iterates, then will flash SUCCESSFUL when achieved or UNSUCCESSFUL if not able to achieve the target pressure window (NOTE: if your system is not hitting presets quickly, change the ADJ value). Enter Settings and Diagnostics mode (press buttons 1+5 for more than 5 seconds), press button 2 (CALIBRATE), then ADJUST SYSTEM to toggle the value between 0 and 10. Higher values increase system fill rates to overshoot target pressures.

Micro adjust to ±1 PSI: If more accuracy is desired, double press the same preset and the system will refine pressures closer to target .

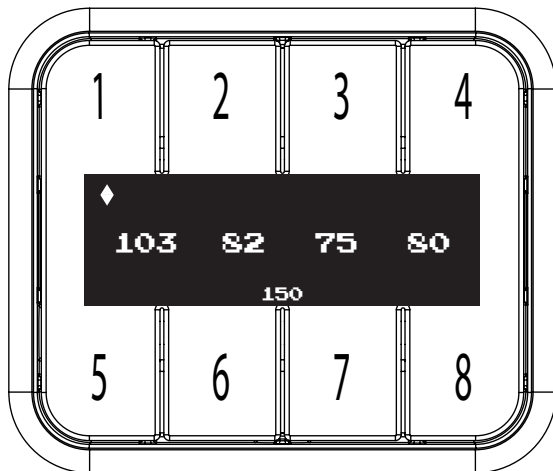

fig. 15 **PRESET Mode**

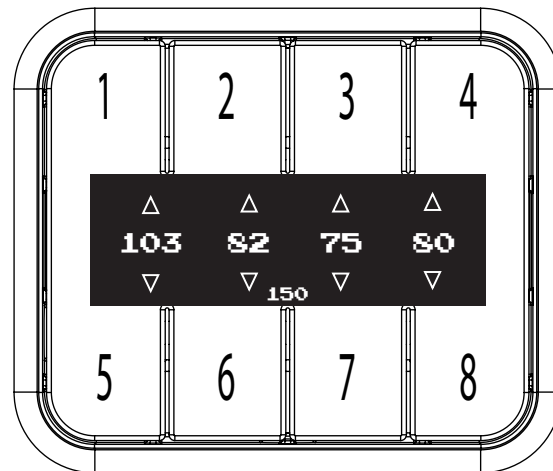

fig. 16 **MANUAL Mode**

MANUAL mode

MANUAL mode allows the user to fill or exhaust each spring. The display will show arrows above and below the pressures to indicate manual control mode. The arrow will be solid when the spring is filling/exhausting, and just an outline when not active.

MANUAL mode with Easy Control™ Tap

The system detects button press time. For a very short (<0.1sec) duration press, the system will open the valves for a defined “burst”, changing pressure minimally so users can fine-tune their pressures. For a longer than 0.1 sec duration press, the valves open as long as you hold the button down. If a button is held active, the fill/exhaust will time out after 10 seconds.

- Fill springs: buttons 1 - 4
- Exhaust springs: buttons 5 - 8

Electrical Schematic

AUTOPILOT V2 GEN 3 PRESSURE CONTROL

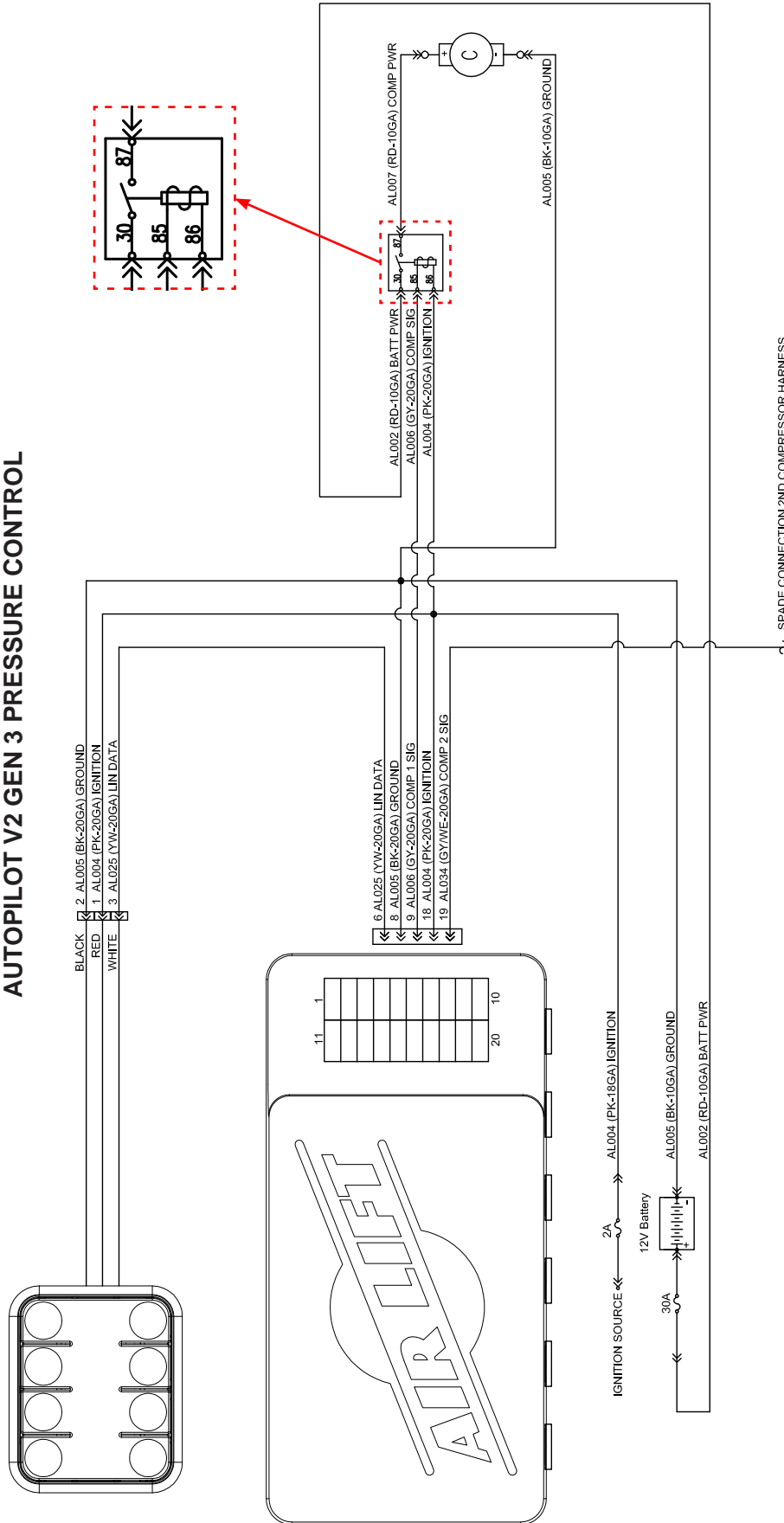

AUTOPILOT V2 SECOND COMPRESSOR HARNESS*

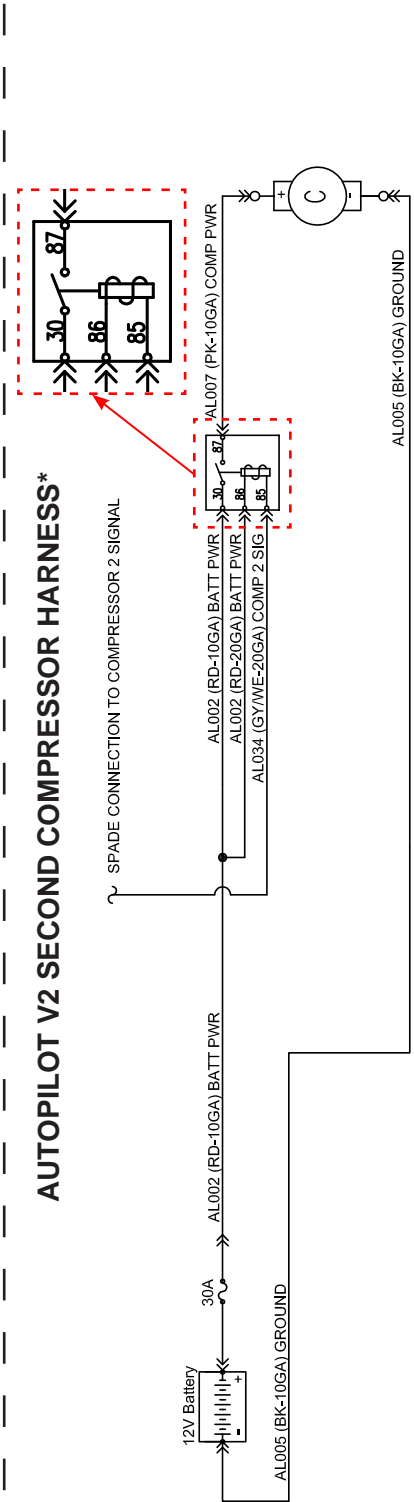

* Sold separately
 Air Lift Part Number 27679

fig. 17

Warranty and Returns Policy

Air Lift Company warrants its performance products for one year to the original purchaser against manufacturing defects one year from the date of purchase when used on cars and trucks as specified under normal operating conditions. The warranty does not apply to products that have been improperly applied, improperly installed, or which have not been maintained in accordance with installation instructions furnished with all products. The consumer will be responsible for removing (labor charges) the defective product from the vehicle and returning it, transportation costs prepaid, to the dealer from which it was purchased or to Air Lift Company for verification.

Air Lift will repair or replace, at its option, defective products or components. A minimum \$10.00 shipping and handling charge will apply to all warranty claims. Before returning any defective product, you must call Air Lift at (800) 248-0892 in the U.S. and Canada (elsewhere, (517) 322-2144) for a Returned Materials Authorization (RMA) number. Returns to Air Lift can be sent to: Air Lift Company • 2727 Snow Road • Lansing, MI • 48917.

Product failures resulting from abnormal use or misuse are excluded from this warranty. The loss of use of the product, loss of time, inconvenience, commercial loss or consequential damages are not covered. The consumer is responsible for installation/reinstallation (labor charges) of the product. Air Lift Company reserves the right to change the design of any product without assuming any obligation to modify any product previously manufactured.

This warranty gives you specific legal rights and you may also have other rights that may vary from state-to-state. Some states do not allow limitations on how long an implied warranty lasts or allow the exclusion or limitation of incidental or consequential damages. The above limitation or exclusion may not apply to you. There are no warranties, expressed or implied including any implied warranties of merchantability and fitness, which extend beyond this warranty period. There are no warranties that extend beyond the description on the face hereof. Seller disclaims the implied warranty of merchantability. Dated proof of purchase required.

Replacement Information

If you need replacement parts, contact the local dealer or call Air Lift customer service at (800) 248-0892. Most parts are immediately available and can be shipped the same day.

Contact Air Lift Company customer service at (800) 248-0892 first if:

- Parts are missing from the kit.
- Broken or defective parts in the kit.
- Technical assistance on installation or operation is needed.
- Wrong parts in the kit.
- Have a warranty claim or question.

Contact the retailer where the kit was purchased:

- If it is necessary to return or exchange the kit for any reason.
- If there is a problem with shipping, if shipped from the retailer.
- If there is a problem with the price.

Contact Information

If you have any questions, comments or need technical assistance contact our customer service department by calling (800) 248-0892, Monday through Friday. For calls from outside the USA or Canada, our local number is (517) 322-2144. You may also contact customer service anytime by e-mail at techsupport@airliftperformance.com.

For inquiries by mail, our address is PO Box 80167, Lansing, MI 48908-0167. Our shipping address for returns is 2727 Snow Road, Lansing, MI 48917.

You may also contact our sales team anytime by e-mail at sales@airliftperformance.com or on the web at www.airliftperformance.com.

Manifold Template

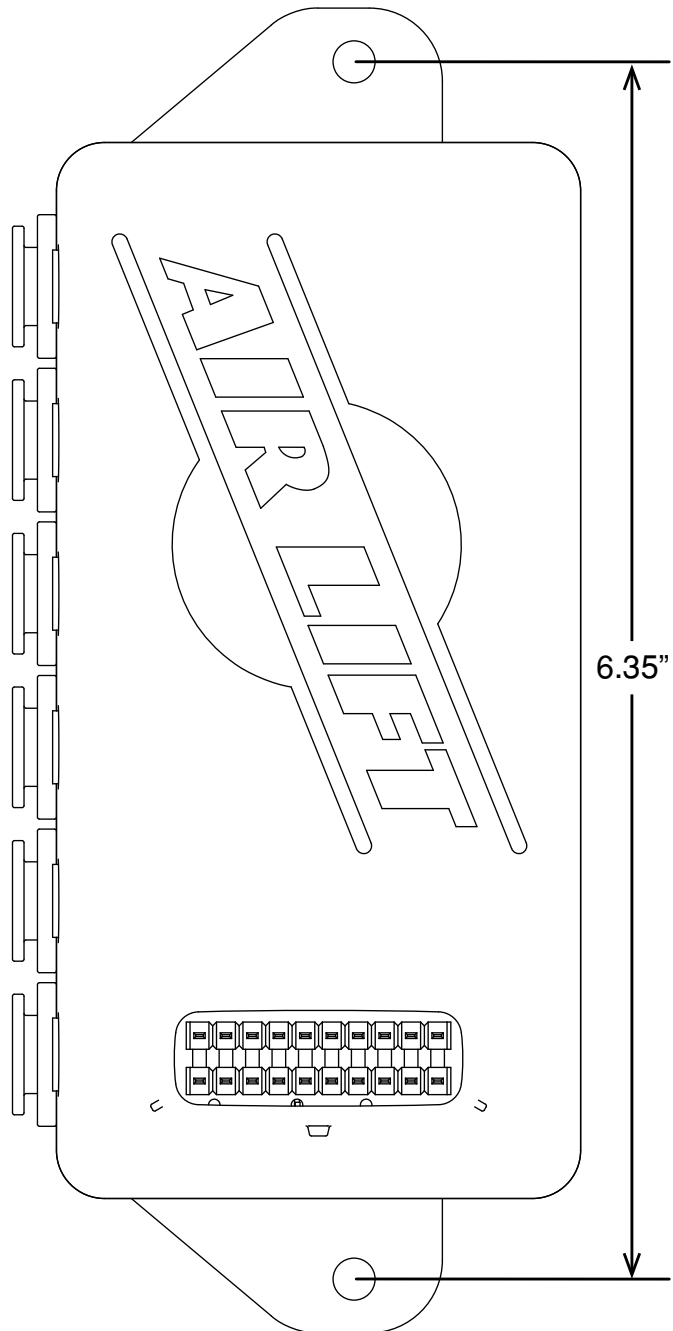

AutoPilot V2 Remote Control Unit

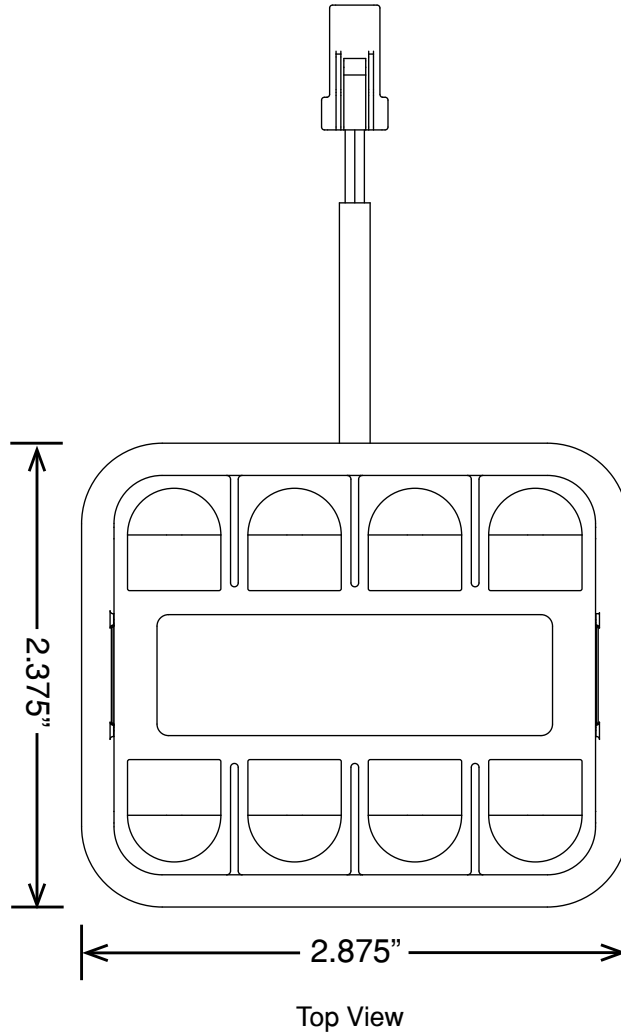

16380 Compressor Template

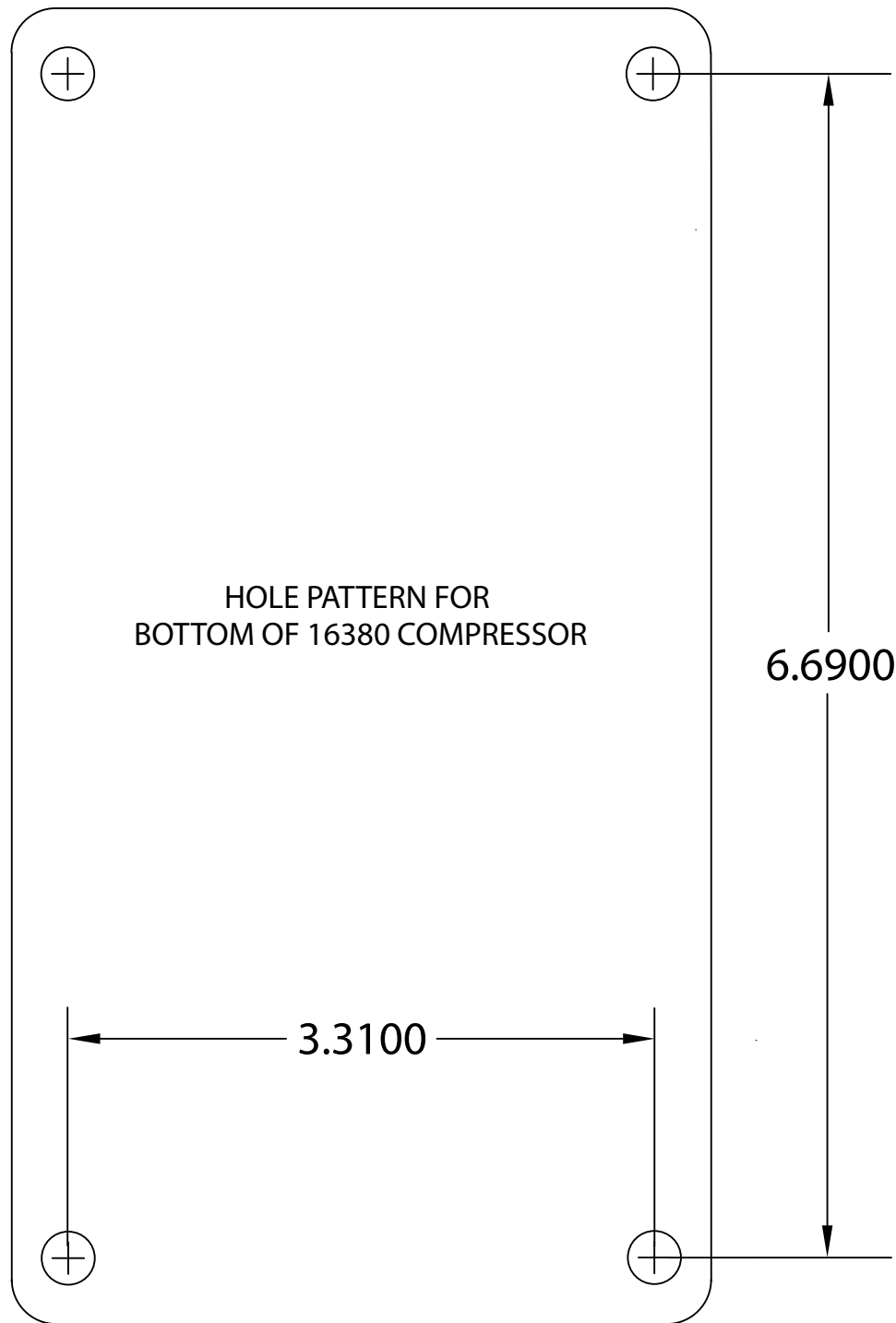

Need Help?

Contact our customer service department by calling (800) 248-0892, Monday through Friday. For calls from outside the USA or Canada, our local number is (517) 322-2144.



Thank you for purchasing Air Lift Performance products!

Air Lift Company • 2727 Snow Road • Lansing, MI 48917 or PO Box 80167 • Lansing, MI 48908-0167
Toll Free (800) 248-0892 • Local (517) 322-2144 • Fax (517) 322-0240 • www.airliftperformance.com

Printed in
the USA