



# BX1131

## 2011 Jeep Liberty Renegade 2012 Jeep Liberty Sport Installation Instructions

Attachment Tab Height: 17.5"

Attachment Tab Width: 24"

Serial Number

**Please read BOTH these Installation Instructions and the General Instructions prior to installing or operating this equipment.**

- Blue Ox® towing products and accessories are intended to be installed by Blue Ox® Dealers who are familiar with our products and have the equipment and knowledge necessary to do "fit work". Blue Ox® Dealers can be found at [www.blueox.com](http://www.blueox.com) or by contacting our Customer Care Department at (402) 385-3051.
- Many Blue Ox® baseplates are designed to use existing holes and hardware to mount the baseplate to the towed vehicle. Do not assume existing hardware will be adequate for baseplate mounting. Always use hardware supplied in the hardware kit and existing hardware specified in the Installation Instructions.

**Bolt Torque Specifications**  
Torque in Foot-Pounds for Metric Bolts

Bolt Size	Grade 8.8	Grade 10.9
6MM	6	8
8MM	16	22
10MM	31	40
12MM	54	70
14MM	89	117



If the front of your vehicle looks different than this, please call us at (402)385-3051.

**Reference your vehicle owner's manual for manufacturer's towing specifications.**

**Bolt Torque Specifications**  
Torque in Foot-Pounds for Inch Bolts

Bolt Size	Grade 5	Grade 8
1/4"	10	14
5/16"	19	29
3/8"	33	47
7/16"	54	78
1/2"	78	119

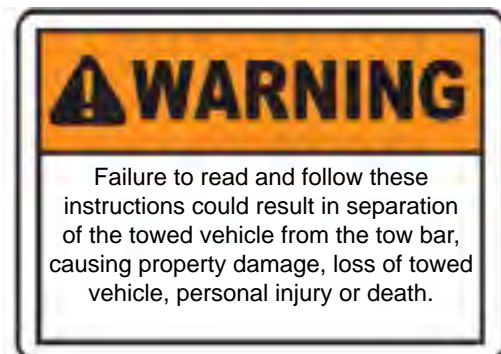



## **BX1131** 2011 Jeep Liberty Renegade 2012 Jeep Liberty Sport Installation Instructions

**Removable Tabs:** Motorhome mounted tow bars are recommended for use with this baseplate. Due to the design of the removable tabs, the RangeFinderII can not be used. Adapters, except the BX8833 and BX88151, can not be used with this baseplate.

**Instruction Notes:** The fascia is removed and reinstalled for the baseplate installation. Drilling is required. Some trimming may also be required.

The dimensional variations between otherwise identical vehicles can be considerable. While the baseplate was designed for easy installation, it may be necessary to tailor the baseplate slightly to compensate for auto manufacturer's tolerances. These minor adjustments may include filing a hole slightly, bending electrical rods or bending end plates.

The BX8869 Tail Light Wiring Kit is recommended for this vehicle.

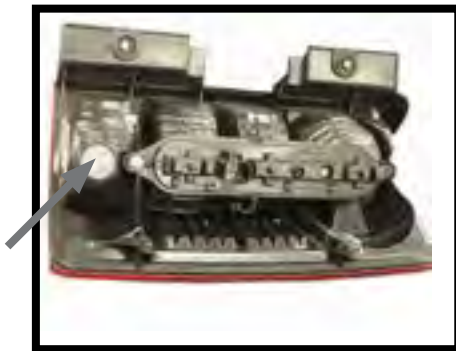

Remove the plastic cap in the tail light assembly and insert 3 wire automotive socket according to the BX8869 installation instructions.



# BX1131

## 2011 Jeep Liberty Renegade 2012 Jeep Liberty Sport Installation Instructions

### Tools Required

10MM Socket  
13/32" Drill  
Tape Measure  
Torque Wrench

9/16" Socket  
Large Vise Grip  
Drill  
Loctite® RED

T25 Torx  
Flat Screwdriver  
Utility Knife

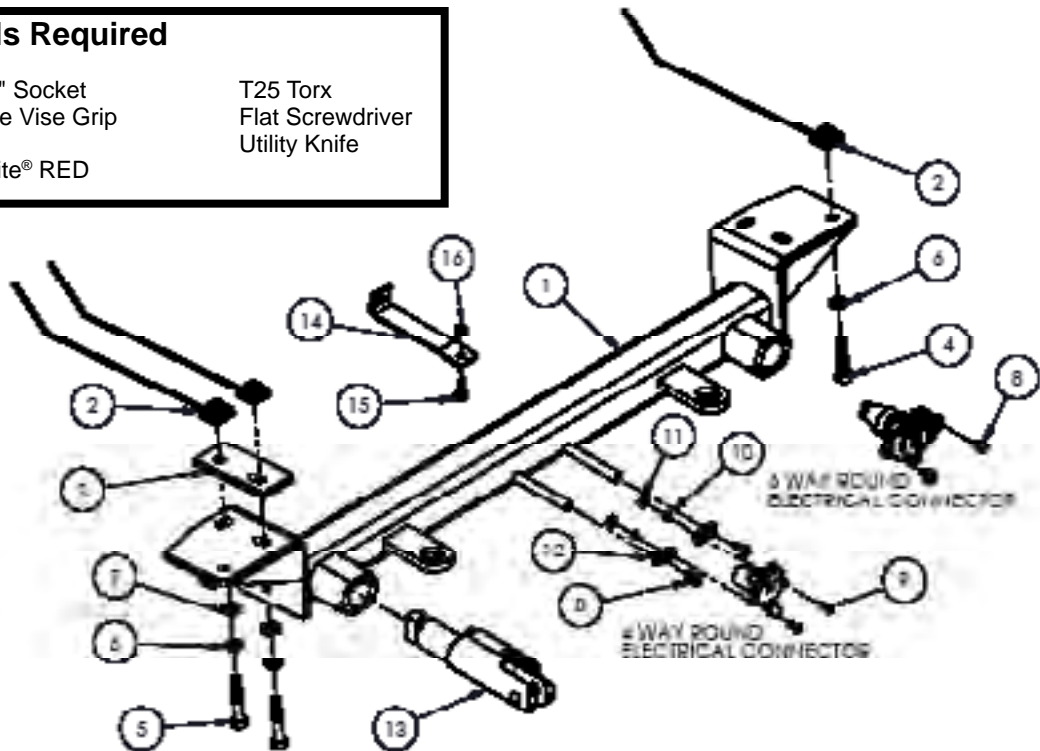

Item No.	Part No.	Description	Qty.
1	61-6906	BX1131 Baseplate Weldment	1
2	61-5208	3/8"-16 Nut Plate Weldment with 14" Wire	6
3	102-6572	BX1976 Backing Plate	2
4	201-0440	3/8"-16 x 1-1/2" Hex Head Bolt, Grade 5, ZP	2
5	201-0444	3/8"-16 x 2" Hex Head Bolt, Grade 5, ZP	4
6	203-0010	3/8" Lock Washer, ZP	6
7	203-0003	3/8" Flat Washer, ZP	4
8	201-0553	1/4"-20 x 1/2" Hex Washed, Type F, ZP	2
9	201-0192	#10-32 1/2" Round Slotted Head Screw	2
10	203-0054	#10 Lock Washer	2
11	202-0047	#10-32 Hex Nut	2
12	101-5822	4 Way Connector Adapter	2
13	62-3468	Attachment Tab Assembly with Hole	2
14	102-7256	BX1131 Breakaway Bracket	1
15	201-0050	1/4"-20 x 3/4" Hex Head Bolt, Grade 5, ZP	1
16	201-0102	1/4"-20 Hex Nut with Nylon Insert, ZP	1
17	226-0046 (not shown)	Class III 36" Baseplate Safety Cable	2
18	229-0359 (not shown)	3/8" Quicklink, ZP	4
19	229-0536 (not shown)	6.3MM Plastic Rivots	4
20	290-0437 (not shown)	Black Receiver Cap Plug	2

### Important

Use only genuine factory replacement parts on your baseplate. Do NOT substitute homemade or non-typical parts. If a bolt is lost or in need of replacement, for your safety and the preservation of your baseplate, be sure to use a replacement bolt of the same grade (In most cases it will be Grade 5, please reference the parts list above). Replacement parts may be ordered through your nearest Blue Ox® Dealer or Distributor, or call our Customer Care Team at (402)385-3051. Failing to follow and/or altering these installation instructions in either installation or required equipment will void the manufacturer's warranty.



1. Release the three (3) push pins located in the wheel well area of the vehicle using a flat screwdriver. Then remove the two (2) pop rivets.



2. Release the push pin that is located on the lower portion of the backside of the fascia, directly in front of the tire, using a flat screwdriver.

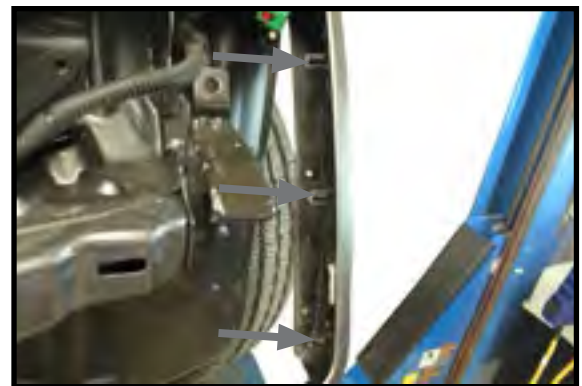
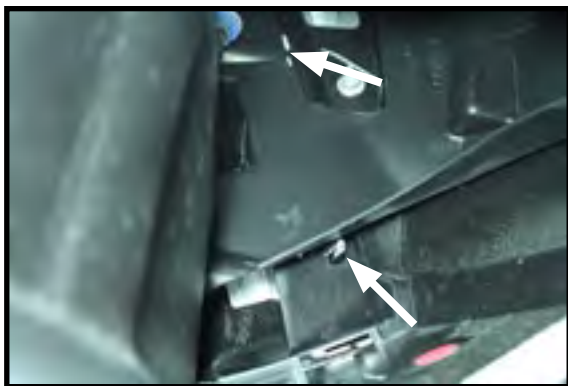

3. Holding the wheel well liner back, remove the three (3) clips. Do this on both sides of the vehicle.

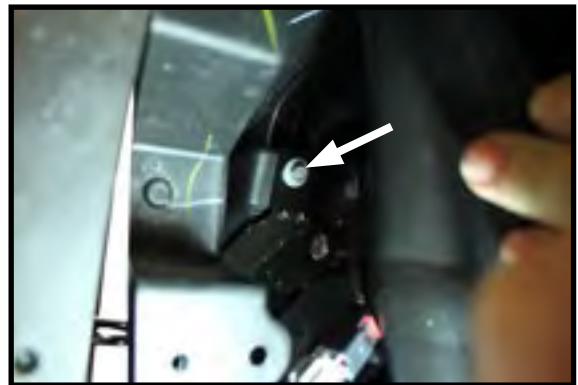

4. With the wheel well liner still pulled back, use a 10MM socket to remove the bolt. Do this on both sides of the vehicle.



5. Press down gently on the plastic guard located beneath the grill in order to prevent damage to the guard.



6. Remove cups on the bumper using a 10mm socket. Set aside to reinstall later.



7. On the driver side only, move the coolant lines down and remove the push pin.

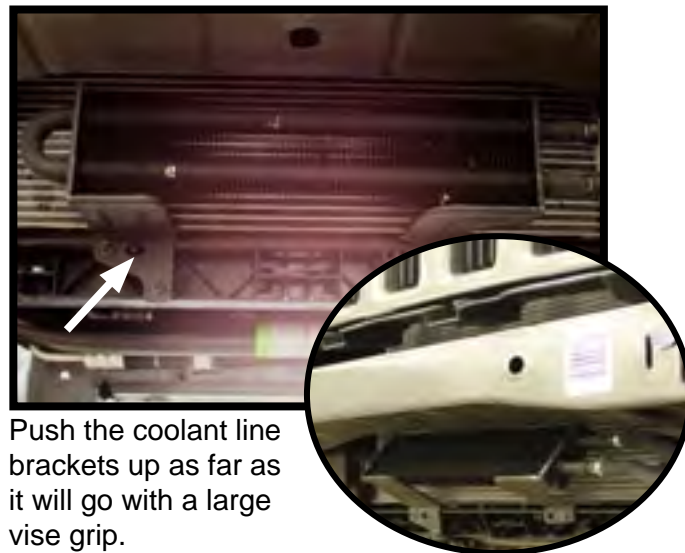

8. Push the coolant line brackets up as far as it will go with a large vise grip.



9. Attach baseplate to the underside of the bumper using the existing two (2) holes. Use a 3/8"-16 x 2" bolt, 3/8" flat & lock washer with a 3/8" nut plate for each hole.

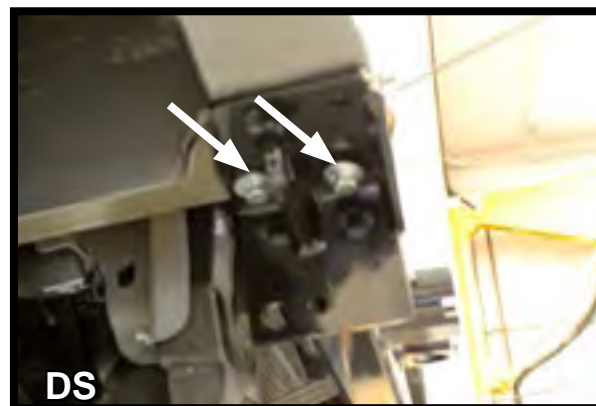

10. Using the endplate as a template, drill an additional hole using a 13/32" drill bit. Install a 3/8"-16 x 1-1/2" bolt, 3/8" lock washer and 3/8" nut plate into hole.





**BX1131**  
2011 Jeep Liberty Renegade  
2012 Jeep Liberty Sport  
Installation Instructions

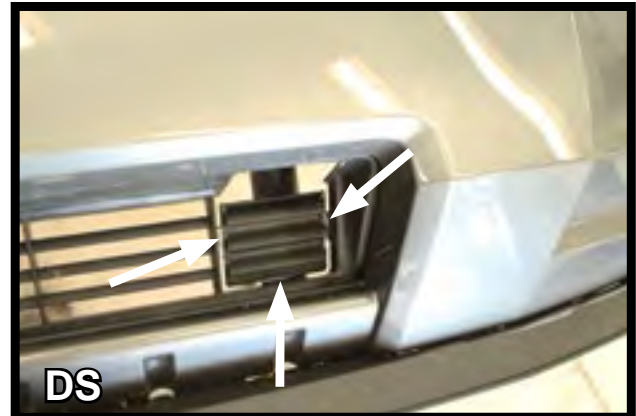
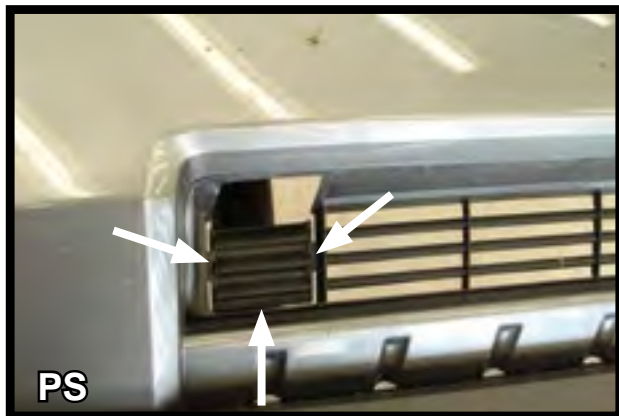

11. Remove the tow hooks if your vehicle is equipped with them. If your vehicle is not equipped with tow hooks, notch the grill as shown in the above diagram
12. Attach the permanent baseplate safety cables to the provided convenience link on the baseplate. Additional options may interfere with suggested mounting; in this case, secure the cables to a solid piece of the frame as described in the instructions included with the permanent baseplate safety cables. Be sure the safety cables do not rub against any hoses or moving parts. Do this on both sides of the vehicle.
13. Reinstall the front fascia. Be sure that all electrical components are plugged in properly.
14. Do not substitute other devices if the tow bar pin and clip are lost.
15. Dealer or installer be certain the end user receives the instruction sheet.

**CUSTOMER SERVICE COMMITMENT**

Blue Ox® is committed to providing you with exceptional customer care throughout your lifetime with our products. Our team is here to assist you with any questions you may have regarding the performance of your product. Simply call (402) 385-3051 and you can speak with our customer care team.

Additionally, please visit our website to see which rallies our Destination America team will be attending. For a nominal fee, our service technician will service your towing system to ensure it's in proper working condition. Also, as a commitment to our customers, should you visit our factory, you can stay at our full service Blue Ox® campground at no charge along with enjoying a factory tour.

Again, thank you for being our customer and for the confidence you have shown in the performance of our products. It is because of customers like you we enjoy the success we have today.



© 2011 Blue Ox  
One Mill Road, Industrial Park  
Pender, Nebraska 68047  
Phone: (402) 385-3051  
Fax: (402) 385-3360  
www.blueox.com