



Baseplate Installation Instructions

BX1684 2005-10 Chevy Cobalt (No Turbo)

Installation Instructions

Serial Number

Please read BOTH these Installation Instructions and the General Instructions before attempting to install or operate this equipment.

- Blue Ox® towing products and accessories are intended to be installed by Blue Ox® Dealers who are familiar with our products and have the equipment and knowledge to do “fit work”. When necessary Blue Ox® Dealers can be found at www.blueox.com or by contacting our Customer Care Department at (402) 385-3051.
- Many Blue Ox® Baseplates are designed to use existing holes and hardware to mount the baseplate to the towed vehicle. Even though bolts are there, do not assume they are adequate for baseplate mounting. Always use hardware supplied in the hardware kit or existing hardware specified in the Baseplate Towing Installation Instructions.

Attachment Tab Height: 14.25”

Attachment Tab Width: 20”

Bolt Torque Specifications
Torque in Foot-Pounds for Metric Bolts

Bolt Size	Grade 8.8	Grade 10.9
6MM	6	8
8MM	16	22
10MM	31	40
12MM	54	70
14MM	89	117

Confirm the towability and pre-towing procedures for your vehicle with the owner’s manual or contact the vehicle’s manufacturer for specific towing procedures.

Bolt Torque Specifications
Torque in Foot-Pounds for Inch Bolts

Bolt Size	Grade 5	Grade 8
1/4”	10	14
5/16”	19	29
3/8”	33	47
7/16”	54	78
1/2”	78	119
5/8”	154	230



If the front of your vehicle looks different than this, call us at (888) 425-5382.

WARNING
Failure to read and follow these instructions could result in separation of the towed vehicle from the tow bar, causing property damage, loss of towed vehicle, personal injury or death.

BX1684

2005-10 Chevy Cobalt (No Turbo)

Installation Instructions

Parts List			
Ref. No.	Qty.	Part No.	Description
1	1	61-6624	Weldment, Base Plate, BX1684
2	9	61-5208	Weldment, 3/8-16 Nut Plate, w/ 14" Wire
3	9	201-0440	3/8-16 x 1 1/2" Hex Bolt, Grd. 5, ZP
4	9	203-0010	3/8" Lock Washer, ZP
5	1	203-0003	3/8" Flat Washer, ZP
6	1	201-0702	6MM-1 X 45MM Hex Bolt, Grd. 8.8, ZP
7	3	203-0001	1/4" Flat Washer, ZP
8	2	201-0071	1/4-20 x 1" Hex Bolt, Grd. 5, ZP
9	2	203-0008	1/4" Lock Washer, ZP
10	2	202-0001	1/4-20 Hex Nut
11	2	62-3469	Attachment, Assembly, SF/ LB (R)
	2	226-0046	Baseplate Safety Cable, 36" CL III (Not Shown)
	4	229-0359	Quicklink, 3/8, ZP (Not Shown)
	2	290-0437	Receiver Cap Plug, Blk (Not Shown)

Tools Required	
7MM Socket	10MM Socket
9/16" Socket	Utility Knife
Large Vise Grip	Loctite® RED

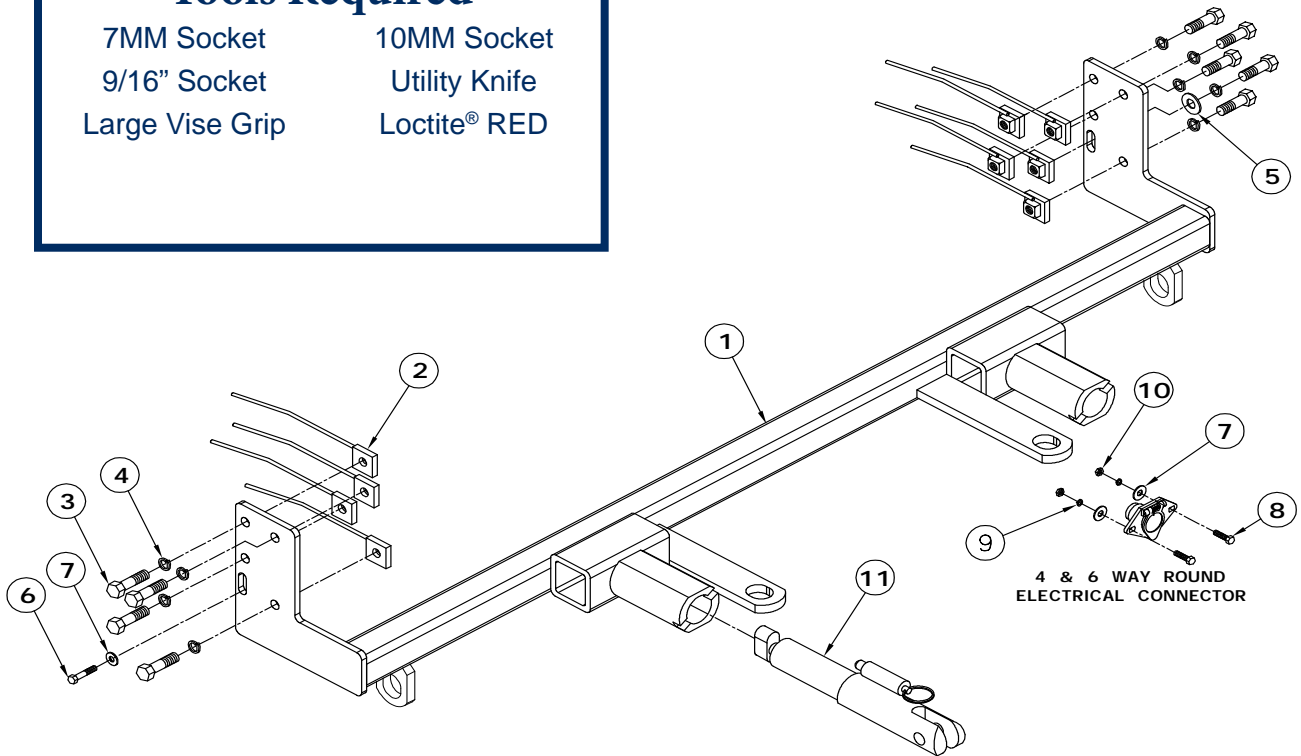

Important:

Use only genuine factory replacement parts on your baseplate. Do **NOT** substitute homemade or non-typical parts. If a bolt is lost or in need of replacement, for your safety and the preservation of your baseplate, be sure to use a replacement bolt of the same grade (In most cases it will be Grade 5, please reference the parts list above). Replacement parts may be ordered through your nearest Blue Ox® Dealer or Distributor. Failing to follow and/or altering these installation instructions in either installation or required equipment will void the manufacturer's warranty. Towing behind a non-motorized vehicle will void the warranty.

BX1684 2005-10 Chevy Cobalt (No Turbo) Installation Instructions

Attachment Tabs:

Motorhome mount tow bars are recommended for use with this baseplate. Due to the design of the removable tabs, the RangeFinderII, Adventurer, and Ambassador tow bars can not be used. The Acclaim tow bar may be used, but will not fold and store on the front of the vehicle. Adapters, except the BX8833 and BX88151, can not be used with this baseplate.

Instructions:

The front fascia, and metal bumper are removed for the baseplate installation. Drilling is required. Trimming of the fascia is required.

The dimensional variations between otherwise identical vehicles can be considerable. While the baseplate was designed for easy installation, it may be necessary to tailor the baseplate slightly to compensate for auto manufacturer's tolerances. These minor adjustments may include filing a hole slightly, bending electrical rods or bending end plates.

The front fascia, horn bracket and air ram intake on passenger's side are removed for baseplate installation. Drilling is required. Trimming of air dam is required. The BX8869 Bulb and Socket Wiring Kit is available for this vehicle.



Possible location for the BX8869 on driver's side tail light assembly.

Installation Instructions:

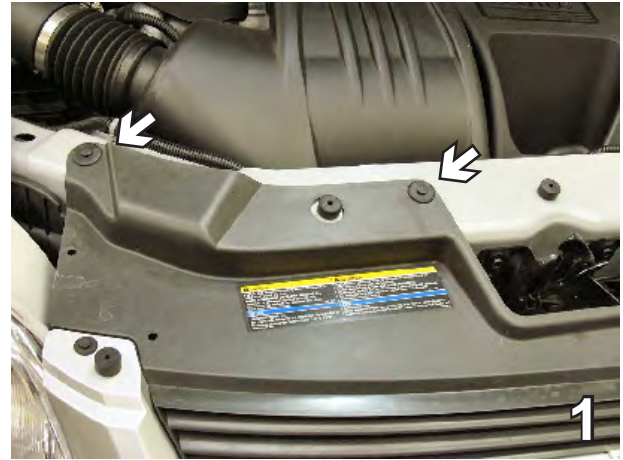

1. Remove the two push pins from the black plastic cover just above the radiator, both sides.



2. Just forward of front tire, on edge of wheel well, are three metric bolts to remove with the 7MM socket, both sides.

Handling of some cosmetic parts when installing this product may require the use of protective covers, rags, specialty tools, etc. to prevent damage.

BX1684
2005-10 Chevy Cobalt (No Turbo)
Installation Instructions



3. Remove the two metric bolts from lower edge of fascia, just forward of front tires with the 7MM socket, both sides.

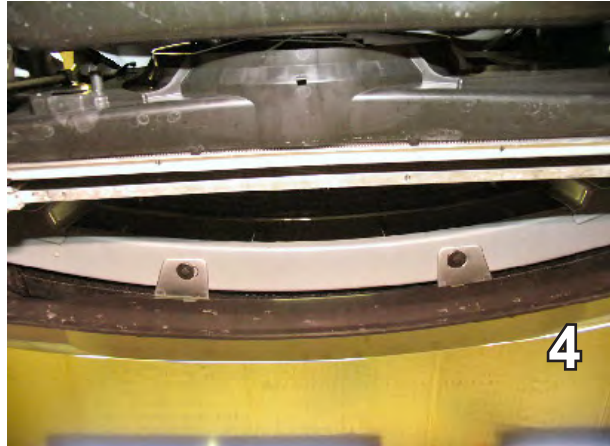

4. Remove the two push pins from the fascia tabs, just below metal bumper, behind fascia.

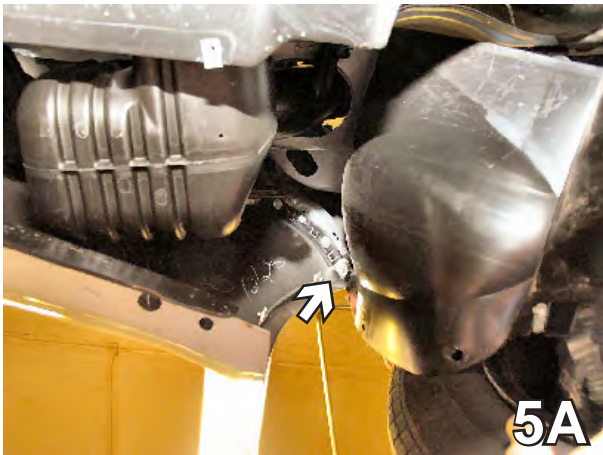

5. Remove the lower metric bolt just forward of the front tire (left photo), on fascia's upper corner, using the 10MM socket, both sides. Loosen the top and bottom remaining metric bolts to release fascia's corner, with the 10MM socket, both sides.



6. Lift up the black plastic just above radiator (step 1), pull fascia's corner out to the side, pull fascia forward both sides, unplug all electrical components if necessary and set fascia aside carefully.

BX1684
2005-10 Chevy Cobalt (No Turbo)
Installation Instructions



7. Remove the metric bolt from the air ram intake tube on the passenger's side with the 10MM socket.



8. Mark a line from outer edge of bumper brace, along the bottom edge of metal bumper and down, flush with the outside edge of frame rail, both sides (view of driver's side). Remove this area with the reciprocating saw, both sides.

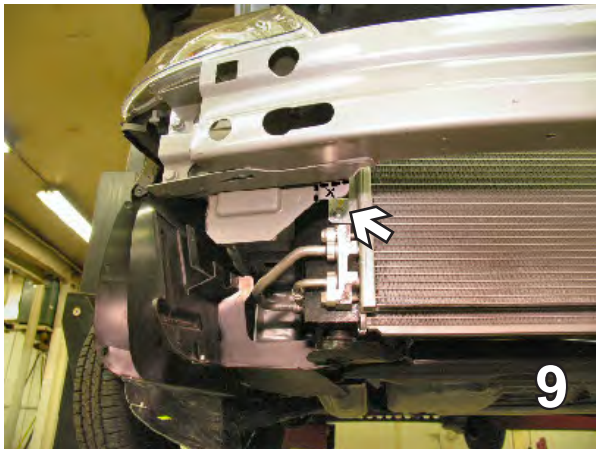

9. Mark a line from inner edge of bumper brace, along the bottom edge of metal bumper and down, flush with the inside edge of frame rail, both sides (view of passenger's side). Remove this area with the reciprocating saw, both sides.

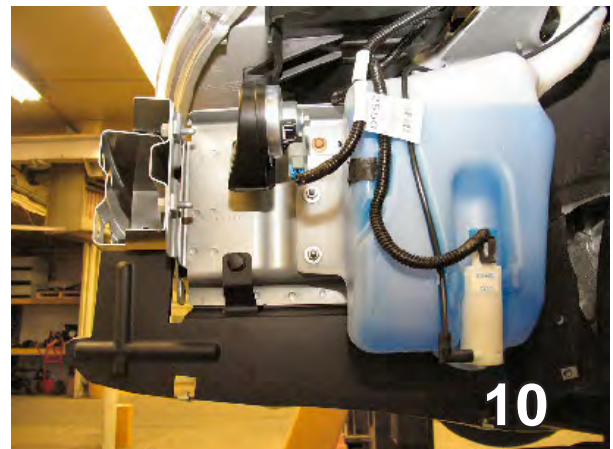

10. Using the 10MM socket, remove the metric bolt from the horn bracket on the driver's side, unplug and set aside.

BX1684

2005-10 Chevy Cobalt (No Turbo)

Installation Instructions



11. Slide the baseplate on to the frame rail to align with the existing hole for the intake tube on the passenger's side, tighten the baseplate to the frame with existing metric bolt from the intake tube and clamp the baseplate to the frame rail on the driver's side with the vise grip. Baseplate should measure approximately 7/8" from the bottom side of frame ribbing down to the top edge of baseplate and as far forward as possible, both sides. **Photo of passenger's side with air intake tube removed to show baseplate installation only. It is not necessary to remove. Air intake should pull out of the way enough for proper installation.**

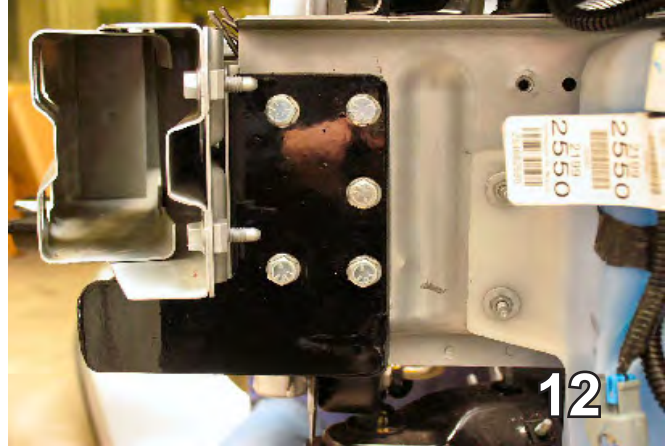

12. Using the baseplate as a template, drill four holes on the driver's side and the four holes on the passenger's side with the 13/32" drill bit. Insert the nut plates into the end of frame rail, just behind metal bumper bracket to align with drilled holes, insert 3/8-16 x 1 1/2" hex bolts and lock washers into baseplate/drilled holes with the 9/16" socket, both sides.

BE SURE TO USE LOCTITE® RED ON ALL BOLTS BEFORE TIGHTENING. TIGHTEN ALL BOLTS ACCORDING TO THE TORQUE CHART ON THE FRONT PAGE OF THESE INSTRUCTIONS OR ON PAGE 3 OF THE BASEPLATE GENERAL TOWING INSTRUCTIONS.

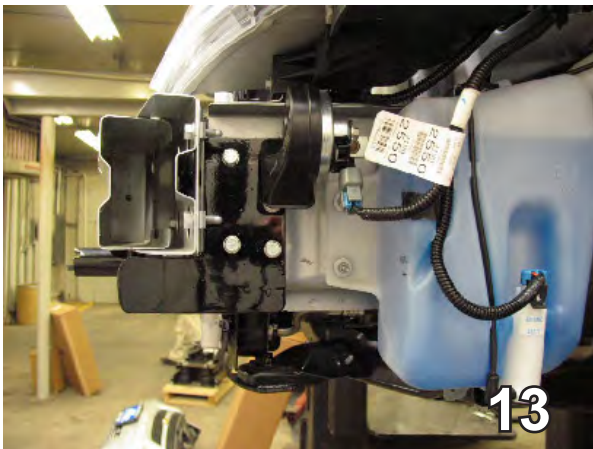

13. Reinstall horn bracket on the driver's side, using the existing equipment with the 10MM socket. **Be sure that all electrical connections are plugged in properly.**

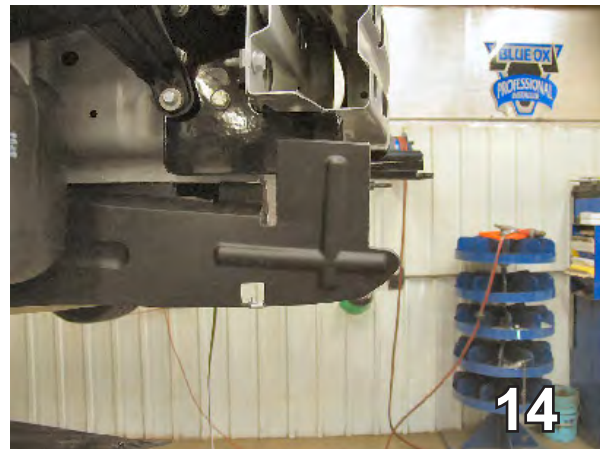

14. Remove existing metric bolt from passenger's side, installed in step 11. Using the 6MM-1.0 x 45MM hex bolt and 1/4" flat washer, reinstall the air intake tube to its original position on the frame.

When using power drills be aware of the dangers of torque and drill bit length.

BX1684
2005-10 Chevy Cobalt (No Turbo)
Installation Instructions

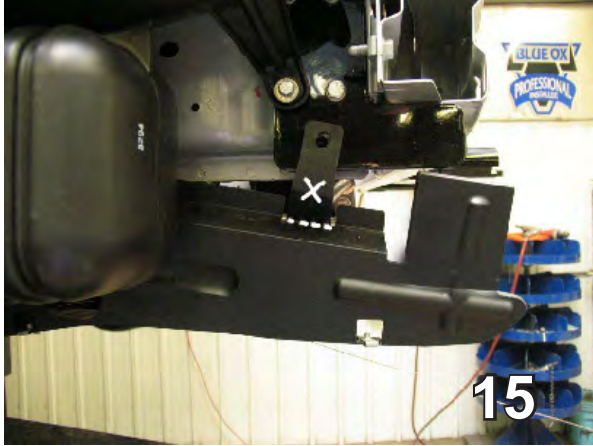

15. Mark a line on the bottom edge of the tab that connects to the intake tube front bolt location and mark a line on the air dam just below metal bumper, both sides. Cut and remove these two areas with the utility knife, both sides.



16. Hold fascia as close to its original position as possible, mark and cut the top style of the lower grill opening, on both sides of the attachment tab receivers to allow tabs to come through. Reinstall fascia. **Be sure all electrical components are plugged in properly.**

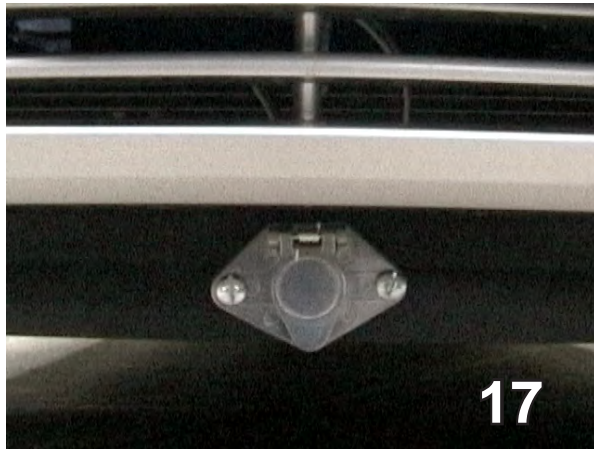

17. *Location for the 4 or 6 pin electrical coupler on the fascia's lower air dam just below license plate.*

Be sure that ALL electrical connections are plugged in properly and functioning BEFORE Installing the fascia.

18. The dimensional variations between otherwise identical cars can be considerable. While the baseplate was designed for easy installation, it may be necessary to tailor the baseplate slightly to compensate for auto manufacturers' tolerances. These minor adjustments may include filing a hole slightly, bending electrical rods, adding and/or bending endplates.
19. Install the tow bar and safety cables according to the instructions included in their packages.
20. Do **not** substitute other devices if the tow bar pin and clip are lost.
21. **DEALER OR INSTALLER: BE CERTAIN THE USER RECEIVES THE INSTRUCTION SHEET.**

BX1684

2005-10 Chevy Cobalt (No Turbo)

Installation Instructions



CUSTOMER SERVICE COMMITMENT

Blue Ox is committed to providing you with exceptional customer care throughout your lifetime with our products. Our team is here to assist you with any questions you may have regarding the performance of your product. Simply call (402) 385-3051 and you can speak with our customer care team.



Additionally, please visit our website to see which rallies our Destination America team will be attending. For a nominal fee, our service technician will service your towing system to ensure it's in proper working condition. Also as a commitment to our customers, should you visit our factory you can stay at our full service Blue Ox campground at no charge along with enjoying a factory tour.

Again thank you for being our customer and for the confidence you have shown in the performance of our products. It is because of customers like you we enjoy the success we have today.

If the baseplate is in an accident, it must be replaced. **DO NOT** use it again! An accident can cause unseen damage and using it again could result in more damage or serious injury. **DO NOT** use the baseplate if it is damaged or missing parts.



© 2009, 10 Blue Ox
One Mill Road, Industrial Park
Pender, Nebraska 68047
Phone: (402) 385-3051
Fax: (402) 385-3360
www.blueox.com