



BX2246

2007-11 Honda CR-V Installation Instructions

Serial Number

Please read BOTH these Installation Instructions and the General Towing Instructions before attempting to install or operate this equipment.

- Blue Ox® towing products and accessories are intended to be installed by Blue Ox® Dealers who are familiar with our products and have the equipment and knowledge to do “fit work”. When necessary, Blue Ox® Dealers can be found at www.blueox.com or by contacting our Customer Care Department at (402) 385-3051.
- Many Blue Ox® Baseplates are designed to use existing holes and hardware to mount the baseplate to the towed vehicle. Even though bolts are there, do not assume they are adequate for baseplate mounting. Always use hardware supplied in the hardware kit or existing hardware specified in the Baseplate Installation Instructions.

Attachment Tab Height: 16”

Attachment Tab Width: 19”

Bolt Torque Specifications
Torque in Foot-Pounds for Metric Bolts

Bolt Size	Grade 8.8	Grade 10.9
6MM	6	8
8MM	16	22
10MM	31	40
12MM	54	70
14MM	89	117

Confirm the towability and pre-towing procedures for your vehicle with the owner’s manual or contact the vehicle’s manufacturer for specific towing procedures.

Bolt Torque Specifications
Torque in Foot-Pounds for Inch Bolts

Bolt Size	Grade 5	Grade 8
1/4”	10	14
5/16”	19	29
3/8”	33	47
7/16”	54	78
1/2”	78	119
5/8”	154	230



If the front of your vehicle looks different than this, call us at (402) 385-3051.

⚠ WARNING

Failure to read and follow these instructions could result in separation of the towed vehicle from the tow bar, causing property damage, loss of towed vehicle, personal injury or death.



BX2246

2007-11 Honda CR-V Installation Instructions

Parts List

Ref. No.	Qty.	Part #	Description
1	1	61-6336	Weldment, Base Plate, BX2246
2	4	61-5208	3/8" Nut Plate, with Wire
3	4	201-0443	3/8-16 x 1" Hex Bolt, Grd. 5, ZP
4	4	201-0368	3/8-16 x 1 1/4" Hex Bolt, Grd. 5, ZP
5	8	203-0010	3/8" Lock Washer
6	4	202-0003	3/8-16 Hex Nut, ZP
7	2	201-0553	1/4-20 x 1/2" Hx. Wshd, Type F Screw
8	2	201-0192	#10-32 x 1/2 Slot, Rd. Hd. Screw
9	2	203-0054	#10 Lock Washer
10	2	202-0047	#10-32 Hex Nut
11	2	101-5822	Adapter, 4 Way Connector
12	2	62-3468	Attachment, Assembly, SF/SB (R)
13	1	102-7056	Breakaway Bracket, BX2246
14	2	201-0050	1/4-20 X 3/4 Hex Bolt Grd.5, ZP
15	2	202-0102	1/4-20 Hex Nyl Nut, ZP
	2	290-0437	Cap Plug, Plug (Not Shown)
	2	226-0046	Permanent Baseplate Safety Cables (Not Shown)
	2	229-0359	3/8" Quick Link (Not Shown)

Tools Required

- 10mm Socket
- Phillips Screw Driver
- 12mm Socket
- Utility Knife
- 9/16" Socket
- Hack Saw Blade
- Vise Grips
- Hammer
- Reciprocating Saw
- 9/32" Drill Bit
- Flat Screw Driver
- 13/32" Drill Bit
- Loctite® RED

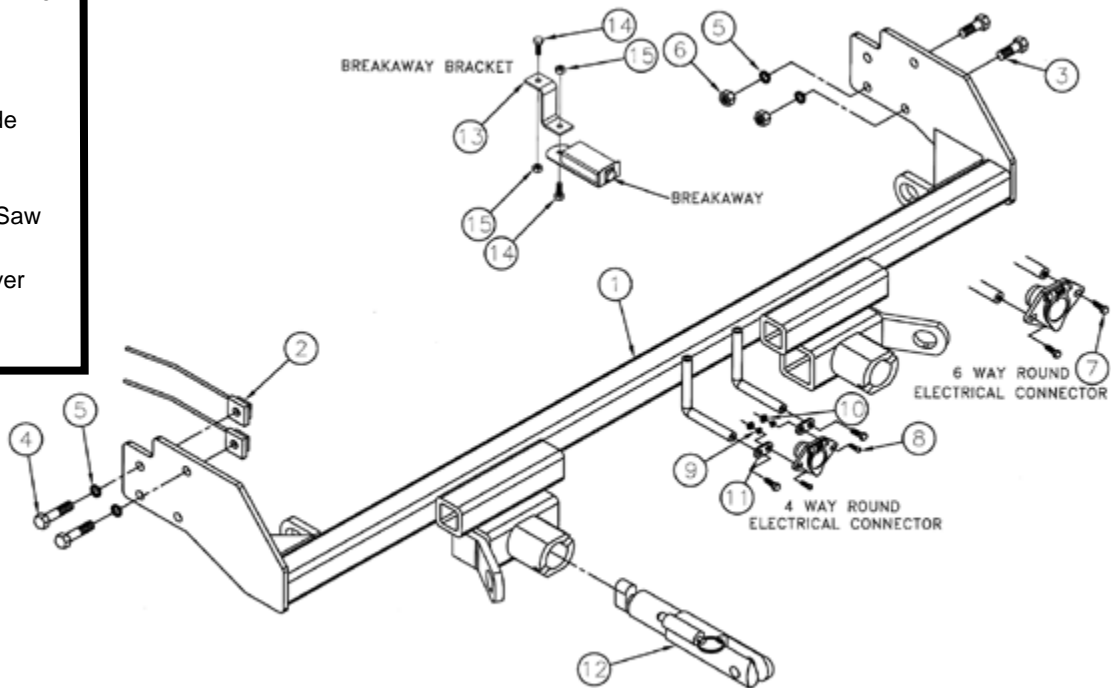

Important:

Use only genuine factory replacement parts on your baseplate. Do **NOT** substitute homemade or non-typical parts. If a bolt is lost or in need of replacement, for your safety and the preservation of your baseplate, be sure to use a replacement bolt of the same grade (In most cases it will be Grade 5, please reference the parts list above). Replacement parts may be ordered through your nearest Blue Ox® Dealer or Distributor. Failing to follow and/or altering these installation instructions in either installation or required equipment will void the manufacturer's warranty. Towing behind a non-motorized vehicle will void the warranty.



BX2246

2007-11 Honda CR-V

Installation Instructions

Attachment Tabs: Motorhome mount tow bars are recommended for use with this baseplate. Due to the design of the removable tabs, the RangeFinderII and Ambassador tow bars can not be used. The Acclaim tow bar may be used, but will not fold and store on the front of the vehicle. Adapters, except the BX8833 and BX88151, can not be used with this baseplate.

Installation Notes: The fascia, air baffle, metal bumper, temperature sensor and washer reservoir are removed for installation. Trimming is required. Drilling is required.

The dimensional variations between otherwise identical vehicles can be considerable. While the baseplate was designed for easy installation, it may be necessary to tailor the baseplate slightly to compensate for auto manufacturer's tolerances. These minor adjustments may include filing a hole slightly, bending electrical rods or bending end plates.

The BX8869 Bulb and Socket Wiring Kit is recommended for this vehicle.

Installation Instructions:

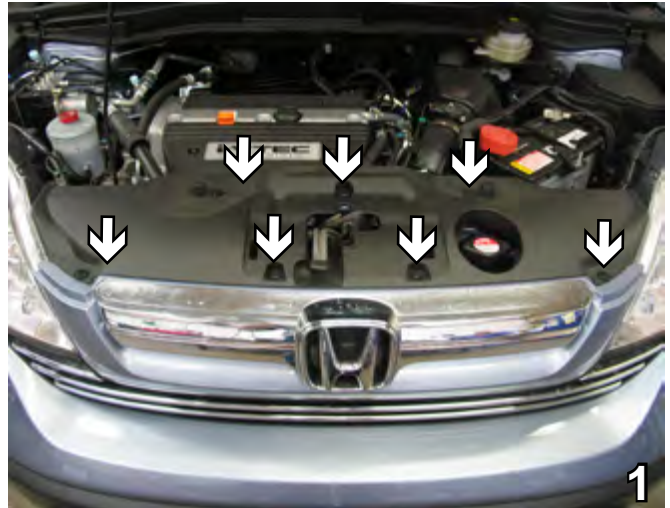

1. Remove seven pushpins from the top of the radiator cover. Pull radiator cover forward to remove. Set radiator cover and pushpins aside to be reinstalled later.



2. Just forward of front tire, inside the wheel well, remove two Phillips screws (see white arrows). Remove one pushpin on the corner of fascia, just above the upper Phillips screw (see grey arrow). Do this to both sides of the vehicle. Set screws and pushpins aside to be reinstalled later.



Possible location for the BX8869 Bulb and Socket Wiring Kit.

Handling of some cosmetic parts when installing this product may require the use of protective covers, rags, specialty tools, etc. to prevent damage.



3. On driver's side, remove one metric bolt from the lower edge of fascia, just forward of front tire, using the 10mm socket. Do this to both sides of vehicle. Set bolts aside to be reinstalled later.

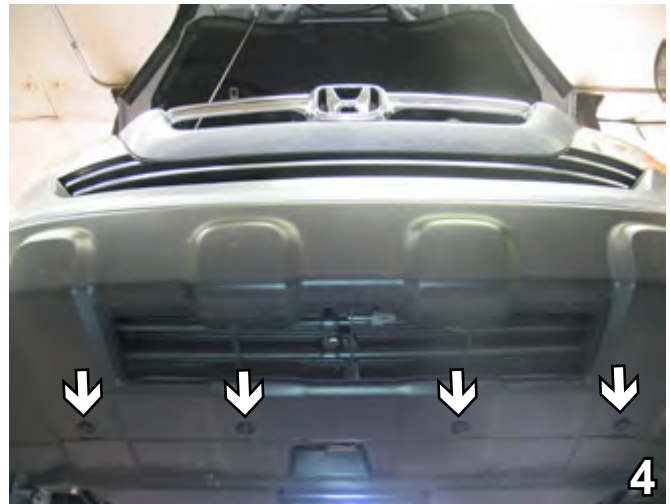

4. Remove four pushpins from the bottom of fascia. Pull fascia corners to the side, then forward to remove. Set pushpins and fascia aside carefully to be reinstalled later.

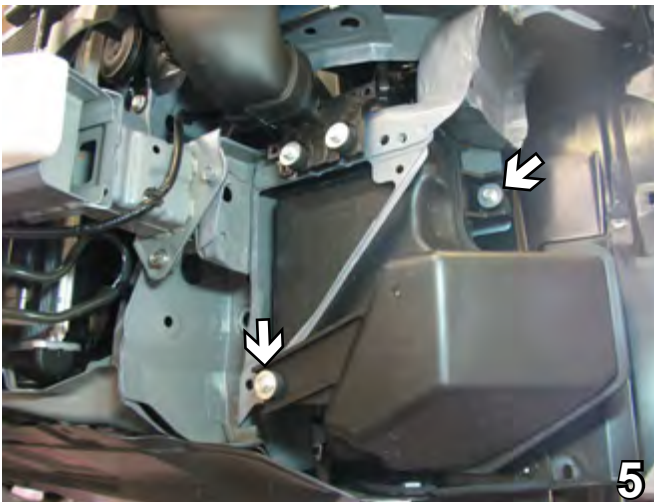

5. On the driver's side, remove two metric bolts from the air baffle using the 10mm socket. Pull air baffle down and out to the side of vehicle to remove. Set bolts and air baffle aside to be reinstalled later.

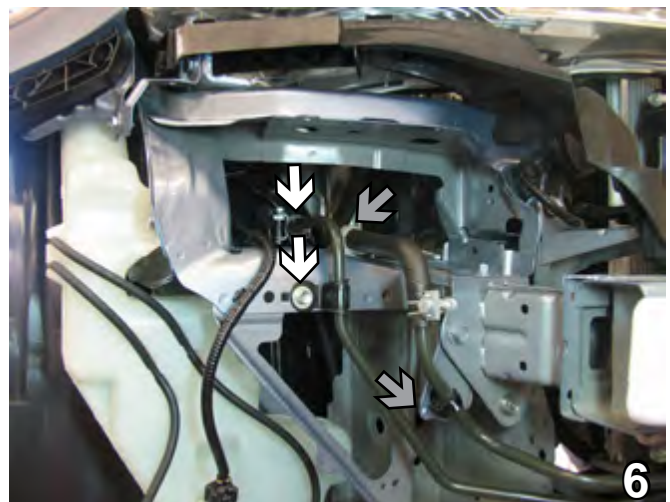

6. On passenger's side, on coolant line closest to washer reservoir, remove one metric bolt using the 10mm socket (see lower white arrow) and disconnect one clip from line (see upper white arrow). On the coolant line closest to frame, disconnect two clips (see grey arrows). The two upper clips will remain on vehicle and the two lower clips are to remain on coolant lines.

BX2246

2007-11 Honda CR-V

Installation Instructions



7. Using the 10mm socket, remove one metric bolt from the coolant line bracket at the bottom of radiator. Set bolt aside to be reinstalled later.



8. On driver's side, remove the coolant line clip from the front of lower frame support just below metal bumper. Do not remove clip from coolant line. Pull the driver's side end of coolant line over to the passenger side of vehicle to clear area for baseplate installation.

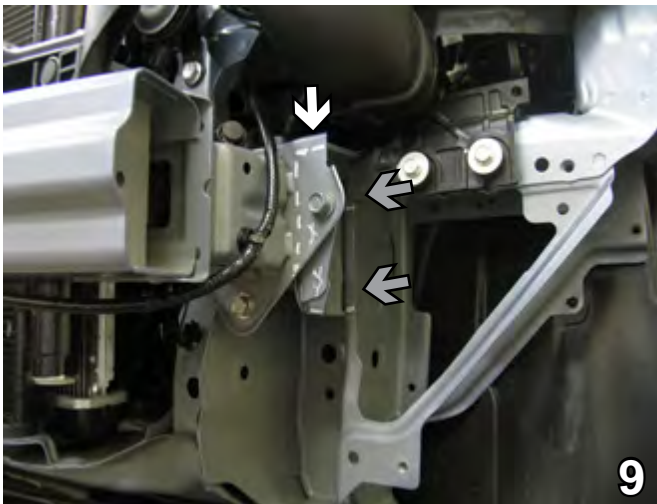

9. Using the reciprocation saw, cut through the webbing of the frame end – making a horizontal cut even with the top edge of frame rail end (see white arrow) starting from the outer edge of webbing and ending flush with the side of frame. Then make a vertical cut starting from the bottom of frame webbing, flush with the side of frame, up to the end of initial cut and remove this portion of webbing. Next make two horizontal cuts on the frame support webbing (see grey arrows) and flatten with the hammer. Do this to both sides of the vehicle.



10. Using the reciprocating saw, cut the metal bumper to make it flush with the side of the frame rail, approximately 1/4" from the end of metal bumper. Do this to both sides of the vehicle. This clears the area for baseplate installation.

BX2246

2007-11 Honda CR-V Installation Instructions

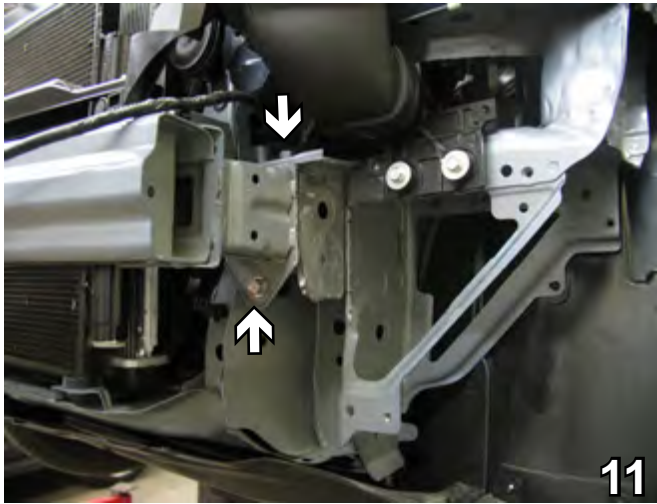

11. Using the 12mm socket, remove two metric bolts (one from the top and one from the bottom) of the metal bumper support. Do this to both sides of the vehicle. Remove the pins attaching the temperature sensor to the bottom of the bumper. Pull bumper forward to remove. Set bolts, bumper, pins and sensor aside to be reinstalled later.

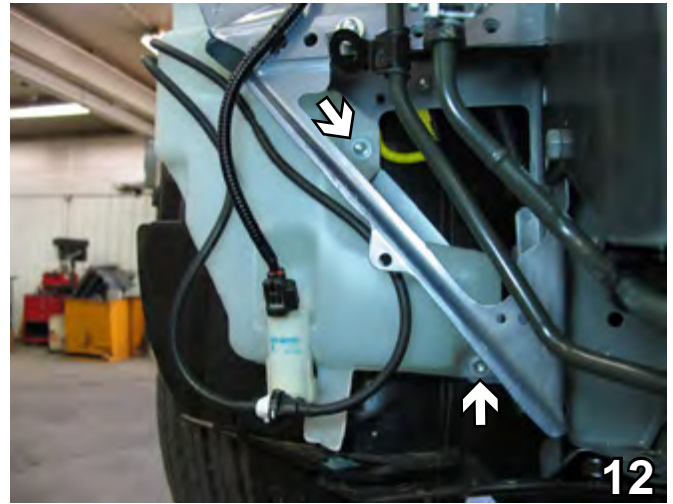

12. On the passenger's side, disconnect and plug the washer reservoir. Remove two metric bolts from the front of reservoir using the 10mm socket. Set bolts aside to be reinstalled later.



13. **2007-09 Models:** Remove one metric bolt from the side of washer reservoir using the 10mm socket. Pull reservoir down and to the side to remove. Set bolts and reservoir aside to be reinstalled later.



13. **2010 Model:** Remove one metric bolt from the back side of washer reservoir using the 10mm socket. Pull reservoir down and to the side to remove. Set bolts and reservoir aside to be reinstalled later.

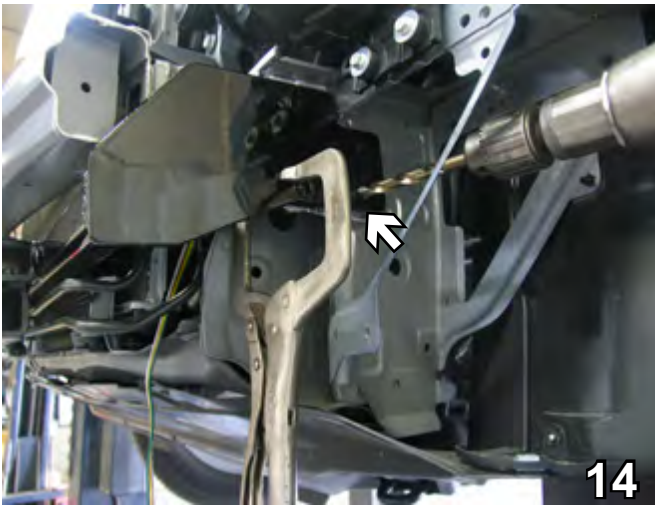

14. On side of frame rail, align baseplate to bottom of the flattened webbing and clamp in place with the vise grips. Using the baseplate as a template, drill four holes into the frame rail with the 13/32" drill bit. Insert two 3/8" nut plates through opening in frame rail end and align to top two holes. Install two 3/8-16 x 1 1/4" hex bolts and 3/8" lock washers to nut plates. Do not tighten. Install bumper. Now, tighten hex bolts. Do this to both sides of the vehicle.

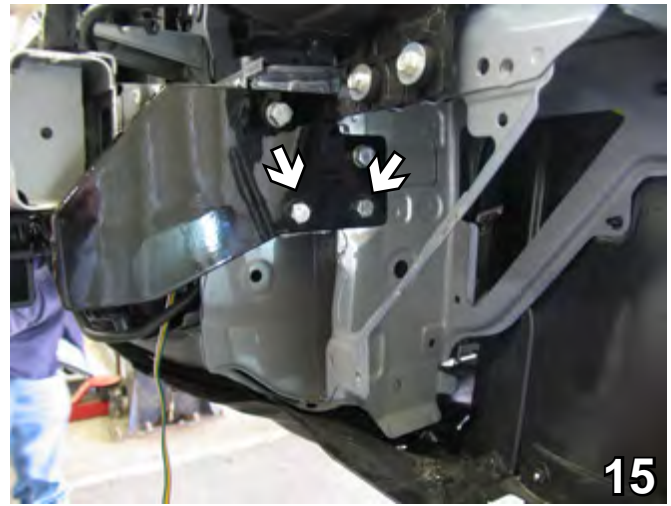

15. In lower drilled holes of baseplate, install two 3/8-16 x 1" hex bolts, 3/8" lock washers and 3/8-16 hex nuts and tighten. Do this to both sides of the vehicle.

When using power drills be aware of the dangers of torque and drill bit length.

BE SURE TO USE LOCTITE® RED ON ALL BOLTS BEFORE TIGHTENING. TIGHTEN ALL BOLTS ACCORDING TO THE TORQUE CHART ON THE FRONT PAGE OF THESE INSTRUCTIONS OR ON PAGE 3 OF THE BASEPLATE TOWING GENERAL INSTRUCTIONS.



16. Relocate coolant line lower. Move bottom coolant line to just above original bolt hole for the bracket. Drill into the bracket using the 9/32" drill bit. Insert 10mm metric bolt into drilled hole and tighten.



BX2246 2007-11 Honda CR-V Installation Instructions



17. Attach the permanent baseplate safety cables to the provided convenience link on the baseplate (see grey arrow). The photo above shows the recommended installation of the cables to frame of vehicle (see white arrow). Additional options may interfere with suggested mounting; in this case secure the cables to a solid piece of the frame as described in the instructions included with the permanent baseplate safety cables. Be sure the safety cables do not rub against any hoses or moving parts. Do this to both sides of the vehicle.

18. Reinstall washer reservoir, temperature sensor, air baffle, coolant line clips on passenger's, the coolant line clip on the driver's side and bolts.

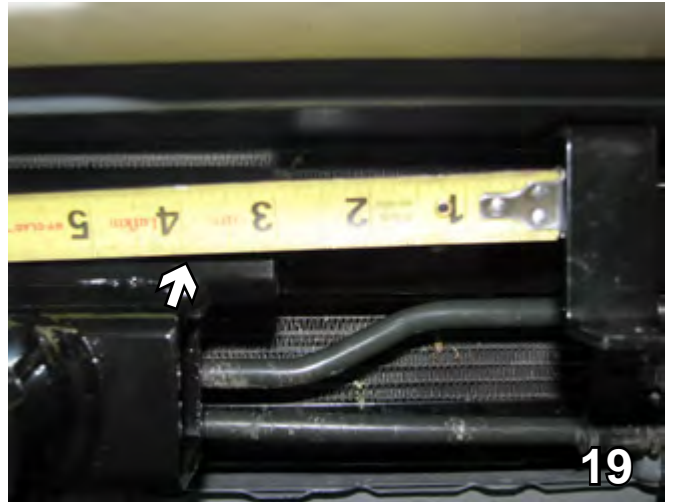

19. Measure 4" from the receiver tube to location position for the breakaway bracket. Drill a hole into the bottom of the metal bumper with 9/32" drill bit.



20. Attach 102-7056 bracket as the breakaway bracket to the underside of the metal bumper with a 1/4-20 x 3/4" bolt and 1/4-20 nut.

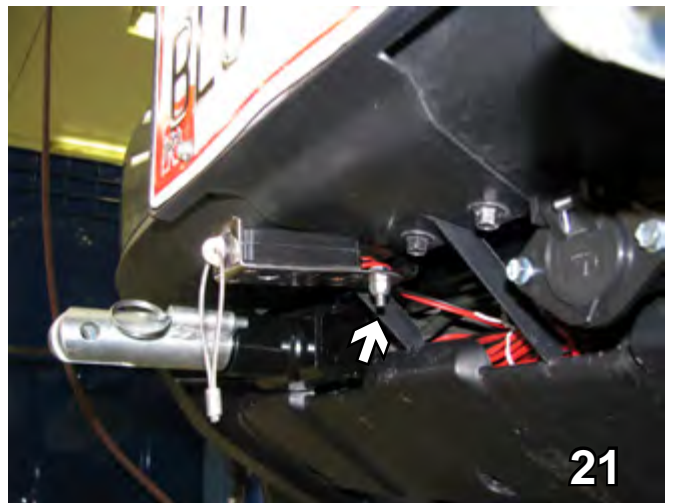

21. Attach the breakaway to the bracket with 1/4-20 x 3/4" bolt and 1/4-20 nut.



BX2246 2007-11 Honda CR-V Installation Instructions



22. Align the fascia to its original position and, using the hack saw blade or utility knife, trim fascia contours to allow room for relocated coolant lines. Do this to both sides of the vehicle. Remove fascia.



23. **2010 Model:** Trim the two outside bars completely off so that the baseplate tabs can come through. Do this on both sides.

24. Reinstall the fascia.

Be sure that **ALL** electrical connections are plugged in properly and functioning **BEFORE** installing the fascia.

DEALER or INSTALLER:

Be certain the user receives the instruction sheets for their products.

If the baseplate is in an accident, it must be replaced. **DO NOT** use it again! An accident can cause unseen damage and using it again could result in more damage or serious injury. **DO NOT** use the baseplate if it is damaged or missing parts.

Install the tow bar and safety cables according to the instructions provided in their packages. When demonstrating this to the customer, be sure to include all the contents and packages.

Do **NOT** substitute other devices if the tow bar pins and clips are misplaced.



BX2246

2007-11 Honda CR-V Installation Instructions



Shown without removable tabs installed.



(2007) - Shown with removable tabs installed.



(2010) - Shown with removable tabs installed.

CUSTOMER SERVICE COMMITMENT

Blue Ox is committed to providing you with exceptional customer care throughout your lifetime with our products. Our team is here to assist you with any questions you may have regarding the performance of your product. Simply call (402) 385-3051 and you can speak with our customer care team.

Additionally, please visit our website to see which rallies our Destination America team will be attending. For a nominal fee, our service technician will service your towing system to ensure it's in proper working condition. Also, as a commitment to our customers, should you visit our factory, you can stay at our full service Blue Ox campground at no charge along with enjoying a factory tour.

Again, thank you for being our customer and for the confidence you have shown in the performance of our products. It is because of customers like you we enjoy the success we have today.



(2011) - Shown with removable tabs installed.