



Equipped with AEM® Dryflow™ Filter
No Oil Required!

INSTALLATION INSTRUCTIONS

PART NUMBER: 21-8302

1998 JEEP Grand Cherokee V8-5.9L
1993 – 1998 JEEP Grand Cherokee V8-5.2L

C.A.R.B. E.O. # D-670
C.A.R.B. E.O. # D-670

* **NOTE:** Legal in California only for racing vehicles which may never be used upon a highway

PARTS LIST

Description	Qty.	Part Number
Air Filter Assy. 3.50 X 9" Dry Ele.	1	21-2049DK
Heat Shield	1	20-8302
Inlet Pipe	1	2-83021
Hose, Silicone 3.50x3" Blk.	1	5-350
Plenum	1	9-8302
Mount, Rubber 1" X 8mm	1	1228560
Zip Tie, 6 Long	2	1-113
Spacer; 1.25"OD TPR. To .438"OD X 1.25"L	1	06402
TB Spacer	1	2-9005
Gskt., TB Spacer	2	2-9203
Gasket, Intake Plenum	1	2-9300
Edge Trim, 6"	1	8-4006
Edge Trim, 9"	1	8-4009
Stud, 1/4-20 2.5" SST	1	1-130
Bolt, Hex M8-1.25 X 20mm	2	1-2034
Washer, M8 Split Lock Zinc	2	1-3036
Washer, 8mm Soft Mount	2	559960
Washer, M8 X 16mm OD Zinc	4	1-3020
Nut, M8-1.25 Hex	2	1-2035
Nut, M8 Hex Serrated	2	444.460.08
1/2" Bnd. Hose Clamp, 3.15"-4.00"	3	9456

Read and understand these instructions **BEFORE** attempting to install this product. Failure to follow installation instructions and not using the provided hardware may damage the intake tube, throttle body and engine.

1. Preparing Vehicle

- a. Make sure vehicle is parked on level surface.
- b. Set parking brake.
- c. If engine has run in the past two hours, let it cool down.
- d. Disconnect negative battery terminal.
- e. Do not discard stock components after removal of the factory system.

2. Removal of stock system



a. Stock air box system.

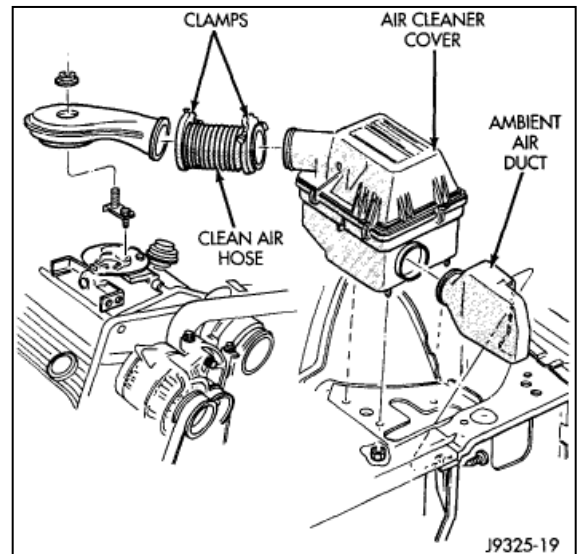

Stock air box configuration (exploded view).

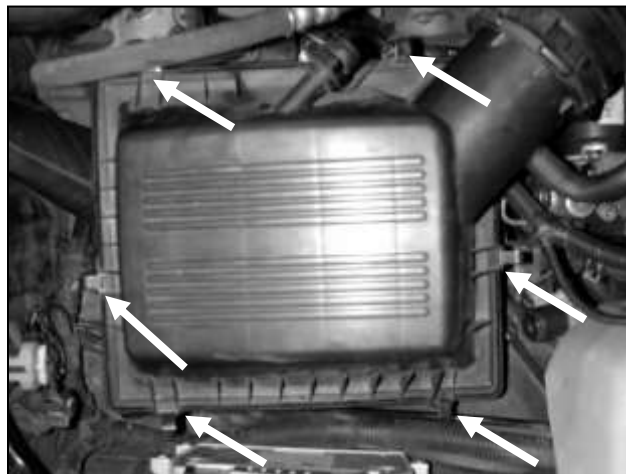

b. Unclip the six clamps that hold down the air box.

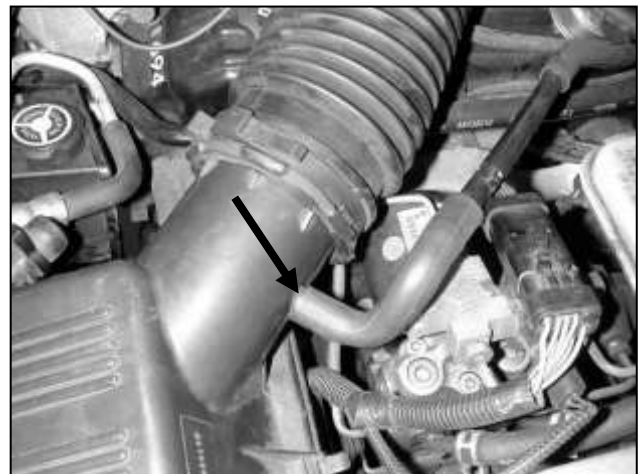

c. Pull breather hose off of intake tube. Loosen both intake hose clamps. Remove intake hose.

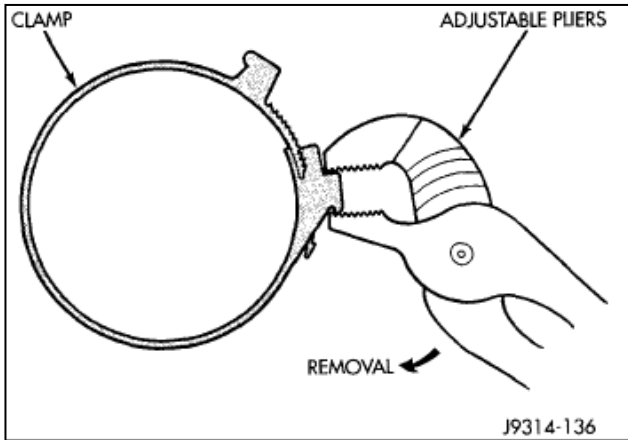

d. Clamp removal.



e. Remove the air cleaner cover and air filter.

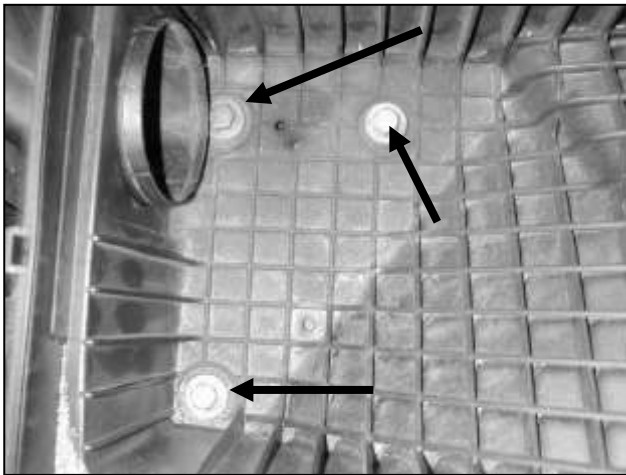

f. Remove the nuts below the three bolts on the bottom of the air box.



g. Unclip small breather hose from the side of the lower air box and then remove lower air box.

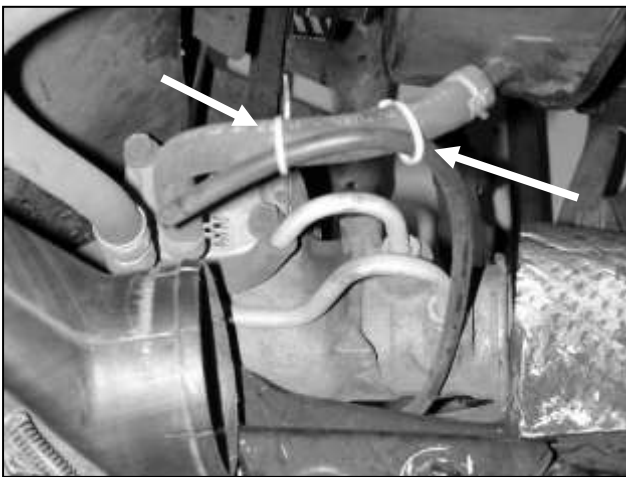

h. Zip tie small breather hose to lower power steering fluid line.

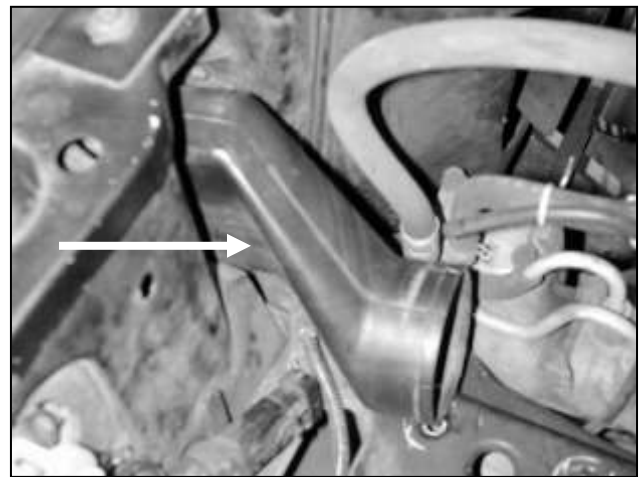

i. Remove ambient air duct. See step 'j' for details on removal of duct.

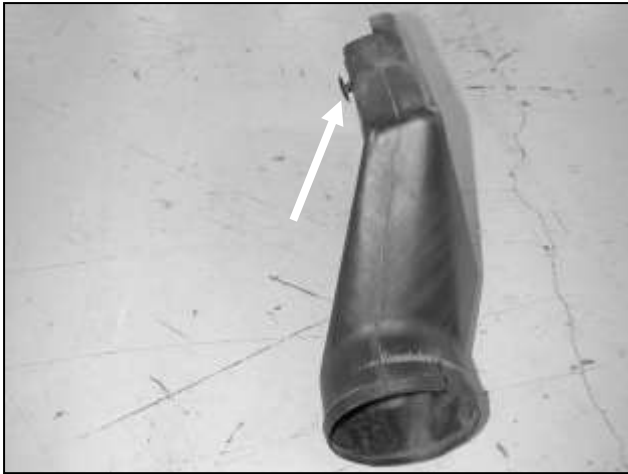

j. Remove plastic plug prior to duct removal.

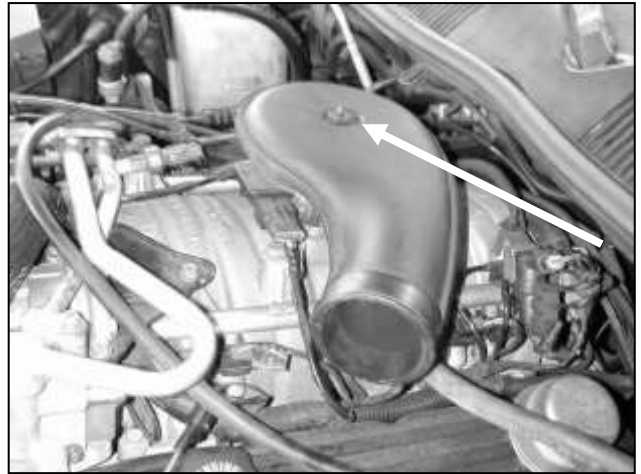

k. Remove plastic nut, and remove plastic housing.

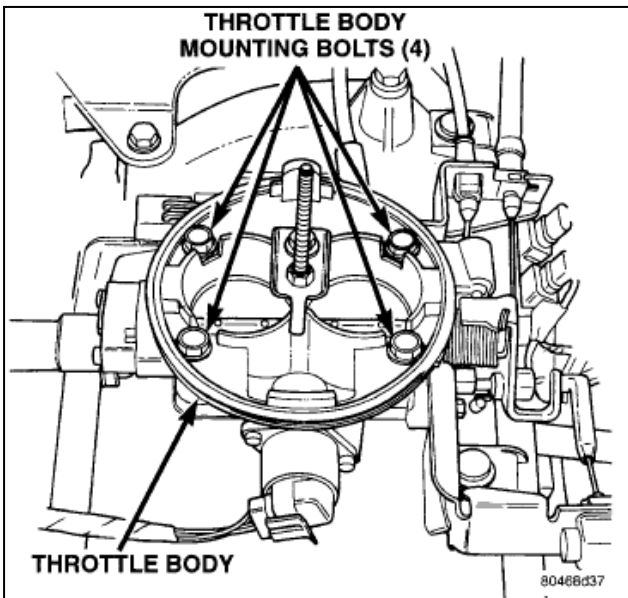

l. Remove the four throttle body bolts.

3. Installation of AEM® throttle body spacer.

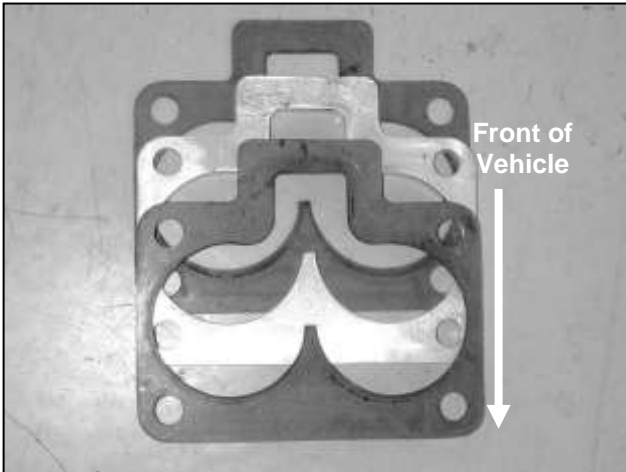

a. Place gaskets above and below throttle body spacer. The flat side of the spacer points towards front of the vehicle.



b. Install throttle body spacer and gaskets under throttle body. Tighten throttle body bolts to 9 ft-lbs.

4. Installation of AEM® intake system.

a. When installing the intake system, do not completely tighten the hose clamps or mounting hardware until instructed to do so.

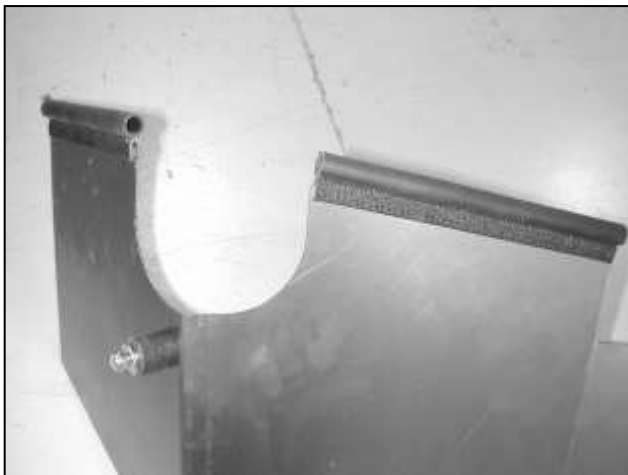

b. Install gasket material on both tops of heat shield.

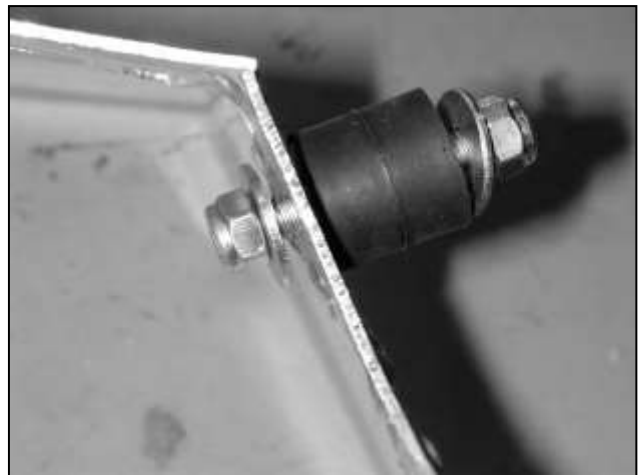

c. Install rubber mount to heat shield as shown.

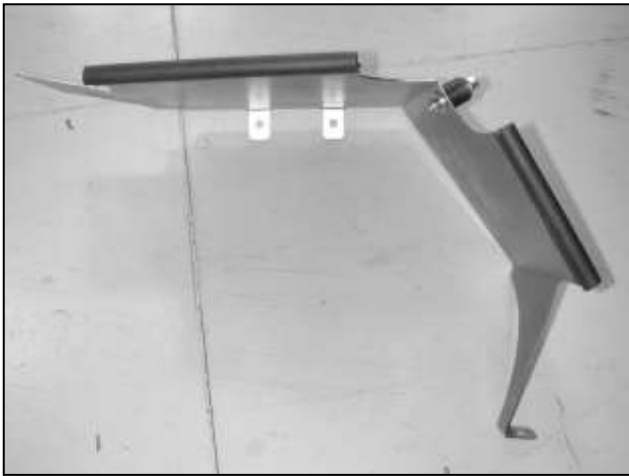

d. The heat shield should look as shown.

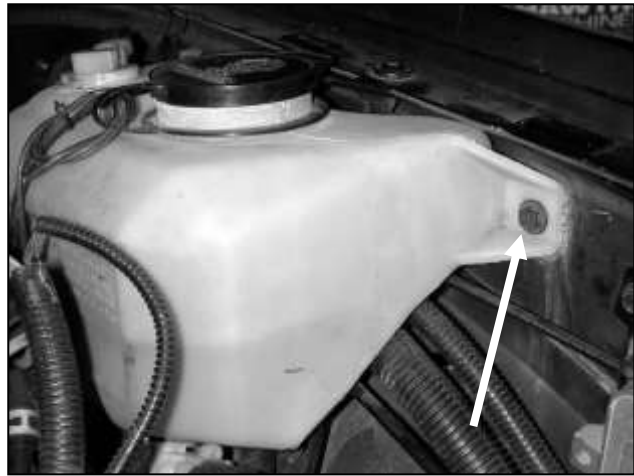

e. Remove washer bottle bolt.



f. Place heat shield in bay as shown.

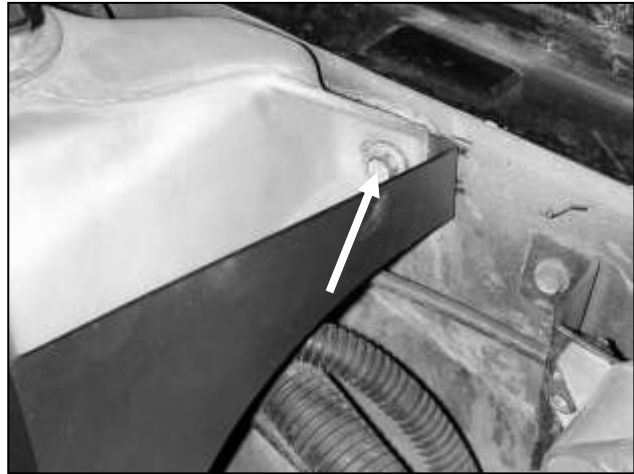

g. Place mounting tab behind plastic tab and secure with the bolt that was removed earlier.

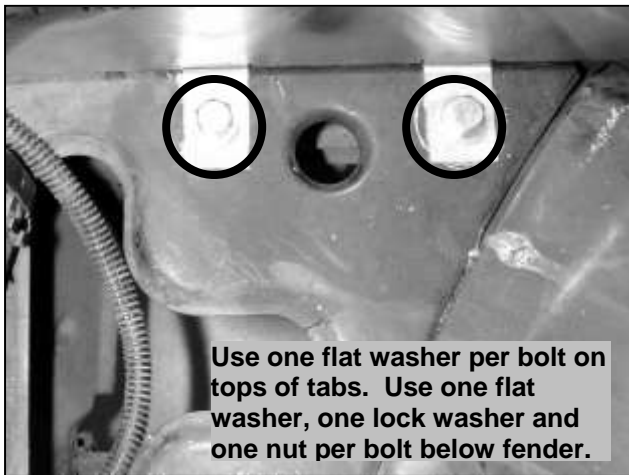

h. Secure bottom mounting tabs with supplied bolts and washers.



i. Remove stock inner plenum support. Place gasket on throttle body and install stud as shown.

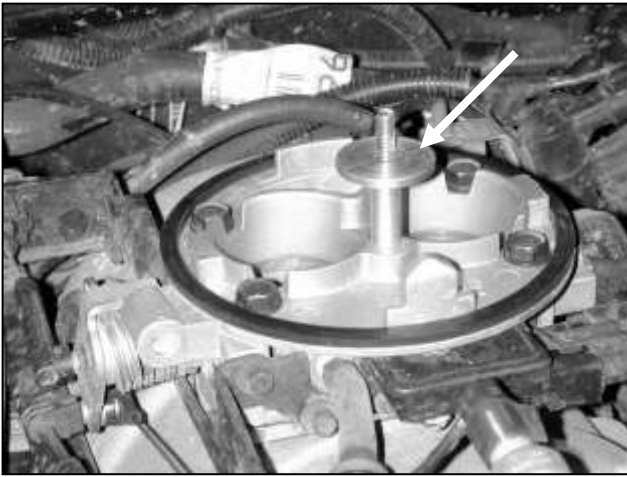

j. Place plenum support as shown. Place new plenum over the support and secure with the stock plenum nut. Do not tighten nut.



k. Attach 3.5 inch hose to end of plenum. Do not tighten hose clamps.



l. Attach the end of the intake pipe to the hose at the plenum. Then attach the air filter and position the intake assembly as shown. Lightly tighten all hose clamps. Ensure that the intake pipe can still be rotated.



m. Place breather hose over nipple on intake pipe. Attach bracket to rubber mount. Do not completely tighten lock nut. See the diagram below.

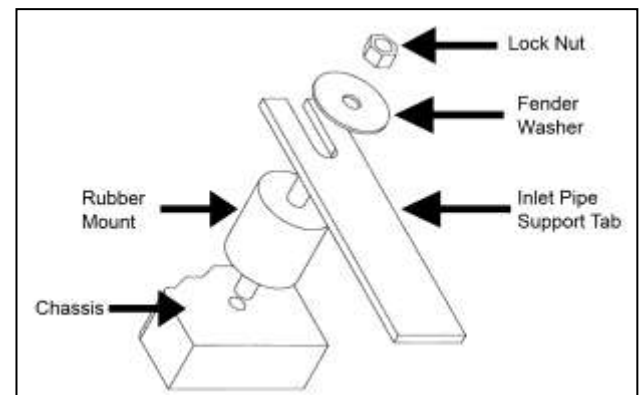



n. Rotate intake pipe to acquire adequate clearance on all sides, especially with respect to the heat shield. Ensure that no part of the intake pipe contacts any surface. Tighten all hose clamps, plenum nut and the nuts on the rubber mount.

5. Reassemble Vehicle

- a. Position the inlet pipes for the best fitment. Be sure that the pipes or any other components do not contact any part of the vehicle. Tighten the rubber mount, all bolts, and hose clamps.
- b. Check for proper hood clearance. Re-adjust pipes if necessary and re-tighten them.
- c. Inspect the engine bay for any loose tools and check that all fasteners that were moved or removed are properly tightened.
- d. Reconnect negative battery terminals and start engine. Let the vehicle idle for 3 minutes. Perform a final inspection before driving the vehicle.

6. CARB Sticker Placement

- a. The C.A.R.B. exemption sticker, (attached), must be visible under the hood so that an emissions inspector can see it when the vehicle is required to be tested for emissions. California requires testing every two years, other states may vary.

7. Service and Maintenance

- a. It is recommended that you service your AEM[®] Dryflow[™] filter every 20,000 miles for optimum performance. Use AEM Dryflow cleaning kit part # 21-110.
- b. Use aluminum polish to clean your polished AEM intake tube.
- c. Use window cleaner to clean your powder coated AEM intake tube. **(NOTE: DO NOT USE aluminum polish on powder coated AEM intake tubes)**

For technical inquiries
e-mail us at
sales@aemintakes.com
or
call us at
800.992.3000

AEM Air Intake System Warranty Policy

AEM® warrants that its intake systems will last for the life of your vehicle. AEM will not honor this warranty due to mechanical damage (i.e. improper installation or fitment), damage from misuse, accidents or flying debris. AEM will not warrant its powder coating if the finish has been cleaned with a hydrocarbon-based solvent. The powder coating should only be cleaned with a mild soap and water solution. Proof of purchase of both the vehicle and AEM intake system is required for redemption of a warranty claim.

This warranty is limited to the repair or replacement of the AEM part. In no event shall this warranty exceed the original purchase price of the AEM part nor shall AEM be responsible for special, incidental or consequential damages or cost incurred due to the failure of this product. Warranty claims to AEM must be transportation prepaid and accompanied with dated proof of purchase. This warranty applies only to the original purchaser of product and is nontransferable. Improper use or installation, use for racing, accident, abuse, unauthorized repairs or alterations voids this warranty. AEM disclaims any liability for consequential damages due to breach of any written or implied warranty on all products manufactured by AEM. Warranty returns will only be accepted by AEM when accompanied by a valid Return Merchandise Authorization (RMA) number. Credit for defective products will be issued pending inspection. Product must be received by AEM within 30 days of the date RMA is issued.

If you have a warranty issue, please call (800) 992-3000 and our customer service department will assist you. A proof of purchase is required for all AEM warranty claims.