

# LoadLIFTER 5000

by AIR LIFT®

# Kit 57214

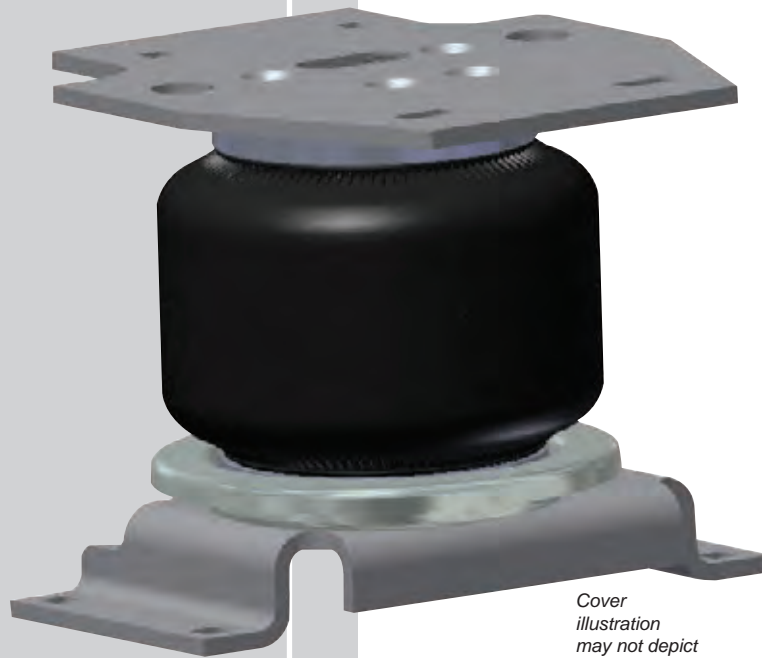

*Cover  
illustration  
may not depict  
actual kit.*



## INSTALLATION GUIDE

For maximum effectiveness and safety, please read these instructions completely before proceeding with installation.

*Failure to read these instructions can result in an incorrect installation.*





# TABLE OF CONTENTS

<b>Introduction</b> .....	<b>2</b>
Important Safety Notice .....	2
Notation Explanation .....	2
<b>Installation Diagram</b> .....	<b>3</b>
<b>Installing the LoadLifter 5000 System</b> .....	<b>4</b>
Getting Started .....	4
Air Line Installation .....	6
Checking For Leaks .....	7
Fixing Leaks .....	7
<b>Before Operating</b> .....	<b>8</b>
Installation Checklist .....	8
Post-Installation Checklist .....	8
<b>Product Use, Maintenance and Servicing</b> .....	<b>9</b>
Minimum and Maximum Pressure .....	9
Maintenance Guidelines .....	9
Troubleshooting Guide .....	9
Frequently Asked Questions .....	10
Tuning the Air Pressure .....	10
Guidelines for Adding Air .....	11
<b>Choosing the Right On-Board Air Compressor System</b> .....	<b>12</b>
<b>Warranty and Returns Policy</b> .....	<b>13</b>
<b>Replacement Information</b> .....	<b>14</b>
<b>Contact Information</b> .....	<b>14</b>



# Introduction

The purpose of this publication is to assist with the installation, maintenance and troubleshooting of the LoadLifter 5000 air spring kit. LoadLifter 5000 utilizes sturdy, reinforced, commercial grade single or double, depending on the kit, convolute bellows. The bellows are manufactured like a tire with layers of rubber and cords that control growth. LoadLifter 5000 kits are recommended for most 3/4 and 1 ton pickups and SUVs with leaf springs and provide up to 5,000 lbs. of load leveling support with air adjustability from 5-100 PSI. The kits are also used in motor home rear kits and some motor home fronts where leaf spring are used.

It is important to read and understand the entire installation guide before beginning installation or performing any maintenance, service or repair. The information here includes a hardware list, tool list, step-by-step installation information, maintenance guidelines and operating tips.

Air Lift Company reserves the right to make changes and improvements to its products and publications at any time. For the latest version of this manual, contact Air Lift Company at (800) 248-0892 or visit our website at [www.airliftcompany.com](http://www.airliftcompany.com).

## IMPORTANT SAFETY NOTICE

The installation of this kit does not alter the Gross Vehicle Weight Rating (GVWR) or payload of the vehicle. Check your vehicle's owner's manual and do not exceed the maximum load listed for your vehicle.

**Gross Vehicle Weight Rating:** The maximum allowable weight of the fully loaded vehicle (including passengers and cargo). This number — along with other weight limits, as well as tire, rim size and inflation pressure data — is shown on the vehicle's Safety Compliance Certification Label.

**Payload:** The combined, maximum allowable weight of cargo and passengers that the truck is designed to carry. Payload is GVWR minus the Base Curb Weight.

## NOTATION EXPLANATION

Hazard notations appear in various locations in this publication. Information which is highlighted by one of these notations must be observed to help minimize risk of personal injury or possible improper installation which may render the vehicle unsafe. Notes are used to help emphasize areas of procedural importance and provide helpful suggestions. The following definitions explain the use of these notations as they appear throughout this guide.



### DANGER

INDICATES IMMEDIATE HAZARDS WHICH WILL RESULT IN SEVERE PERSONAL INJURY OR DEATH.



### WARNING

INDICATES HAZARDS OR UNSAFE PRACTICES WHICH COULD RESULT IN SEVERE PERSONAL INJURY OR DEATH.



### CAUTION

INDICATES HAZARDS OR UNSAFE PRACTICES WHICH COULD RESULT IN DAMAGE TO THE MACHINE OR MINOR PERSONAL INJURY.

## NOTE

*Indicates a procedure, practice or hint which is important to highlight.*

# Installation Diagram

This kit is designed to fit Dodge motorhomes chassis

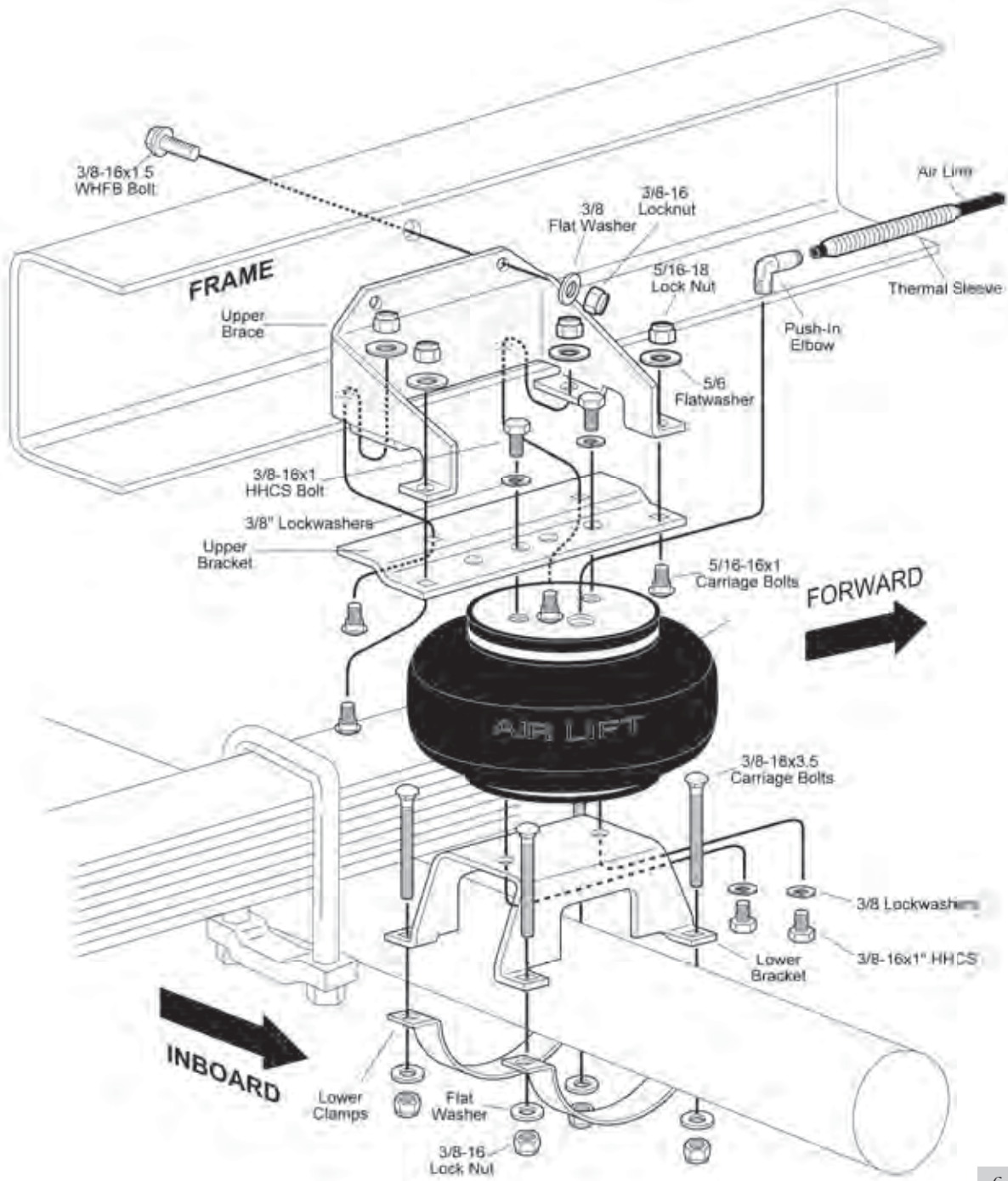

fig. 1



Missing or damaged parts? Call Air Lift customer service at (800) 248-0892 for a replacement part.

# Installing the LoadLifter 5000 System

## WARNING

DO NOT INFLATE BELLOWS WHEN IT IS UNRESTRICTED OR NOT INSTALLED. BELLOWS MUST BE CONTAINED BY SUSPENSION OR OTHER ADEQUATE STRUCTURE. DO NOT INFLATE BEYOND 100 PSI. IMPROPER USE OR OVER-INFLATION MAY CAUSE ASSEMBLY TO BURST CAUSING PROPERTY DAMAGE OR SEVERE PERSONAL INJURY.

## NOTE

**NORMAL RIDE HEIGHT:** Normal ride height (no load) - This is defined as the distance between the bottom edge of the fenderwell to the center point of the wheel with the vehicle in an "as delivered condition" (without a load, i.e. tool box, camper, etc.) measurements should be taken before beginning the installation. The distance from the bottom edge of the fenderwell to the center point of the wheel should be recorded. All of our kits are designed to be installed and operated at normal ride height.

## GETTING STARTED

1. Jack up rear of vehicle or raise on hoist. Place safety jack stands under axle and adjust so that the vehicle is a normal ride height.
2. Position the bellows with the air port down. Secure the lower bracket to the bellows using two 3/8x16x1" hex head bolts, and two 3/8 lock washers (Figure 2). Assemble left and right units. Tighten to 20 ft-lbs.

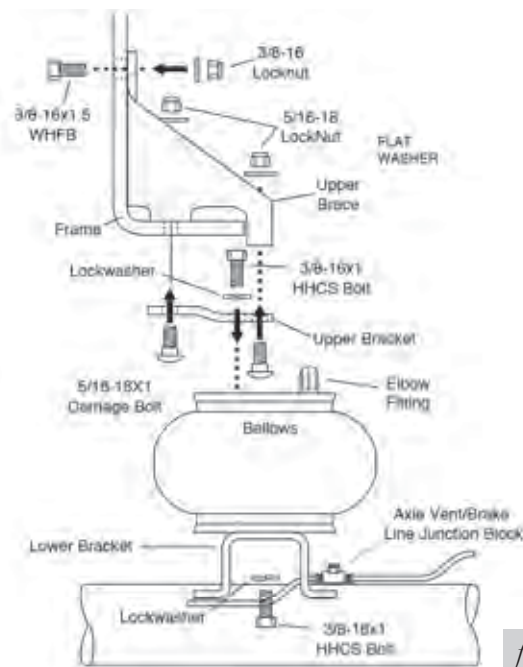

fig. 2

3. Position the bellows with the air port up. Install the air fitting on the top side of bellows. Tighten finger tight plus two turns. Use a 9/16" open end wrench being careful to tighten on the metal hex nut only. DO NOT OVER TIGHTEN. This fitting is precoated with thread sealant. Be sure to position the air fitting so that it faces the front of the vehicle (Figure 1). Repeat for other side.
4. Remove the rubber jounce bumper. This will not be reused.
5. Insert 5/16" carriage bolt into the front outboard hole in each upper bracket (Figure 5).

6. Attach upper bracket to bellows using two 3/8-16x1" HHCS and lock washers (Figure 2). Assemble both sides, making sure to use the correct set of holes (Figure 5). Tighten to 20 ft-lbs.
7. Set the assembly into place on the axle, inboard of the leaf spring (Figure 1 & 2).

**NOTE**

*For pre-1973 chassis (Figure 3), you may need to reform lower straps for square axle housing. This can be accomplished with a bench vise.*

Insert upper brace into frame rail (Figure 1, 2 & 5). Slide it under any lines or wires so that it is against the frame. Align the bottom holes of the upper bracket with the front jounce bumper hole in the frame. Insert the front carriage bolt, inserted in step 5, through the frame rail and the upper brace. Loosely assemble unit with a 5/16" lock nut. Drill remaining hole with a 5/16" drill bit, using bracket as a template. Insert another carriage bolt up from the bottom through upper bracket, frame and upper brace. Secure loosely with lock nut. Some vehicles will have an existing hole in the frame that will match one of the holes in the upper brace. If no hole exists, drill one 3/8" hole using the upper bracket as a template (Figure 5). Insert a 3/8x1.5"WHFB through the frame from the outside. Attach 3/8" lock nut and securely tighten this bolt to 20 ft-lbs., insuring that the brace fits tightly against inner frame rail (Figure 1). Tighten nuts holding upper brackets, frame and inner brace securely. Insert two 5/16" carriage bolts upward through the other holes in the upper bracket and upper brace and retain with lock nuts. Tighten to 20 ft-lbs.

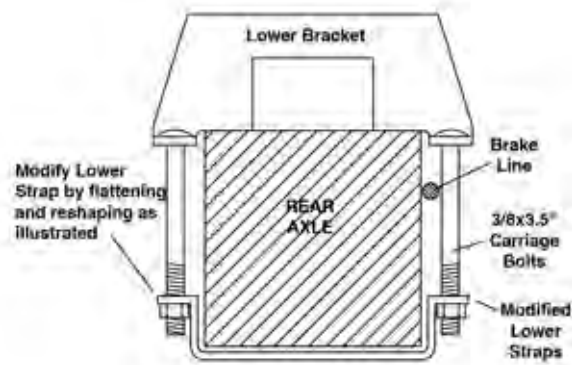

fig. 3

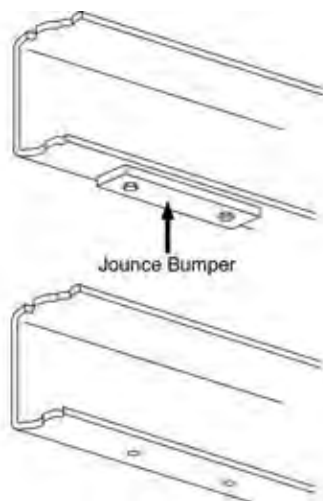

fig. 4

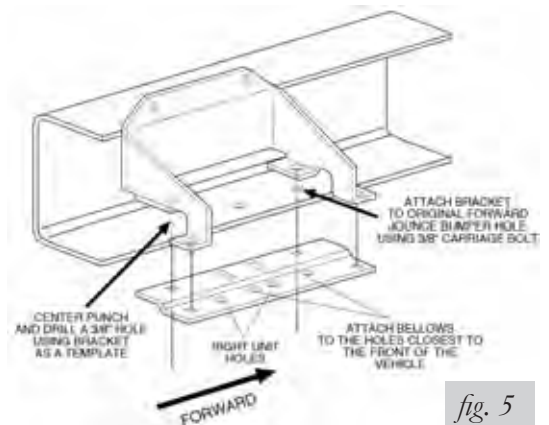

fig. 5

8. Insert carriage bolts down through lower bracket holes and lower clamps and loose assemble with flat washers 3/8-16 nuts.

**NOTE**

*Be sure the brake line is not clamped between the bracket and the axle.*

Align the lower bracket to obtain the best alignment so that the top and bottom bellow mounting plates are parallel both vertically and horizontally. Hold lower bracket in place while securing carriage bolt with the lock nuts (Figure 1).

9. Installation of this kit requires exhaust heat shield (Figure 6). The shield is attached with the stainless steel clamps to the exhaust pipe, with the flanges being bent inward. Shield may be trimmed or bent to attain component clearance. Bend tabs to provide 1/2" dead air space between exhaust pipes and heat shield and maximum clearance with bellows. Tailpipe should be loosened and rotated to provide maximum clearance.

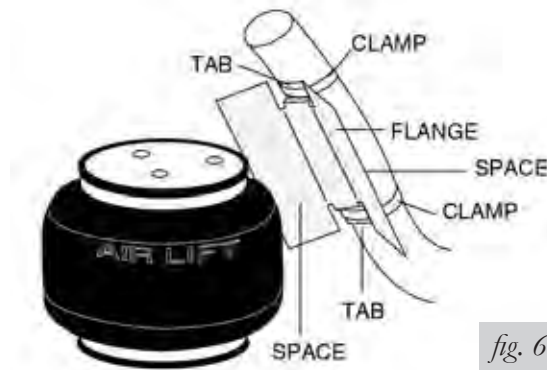
**AIR LINE INSTALLATION**

- A. Select locations on the vehicle for the air inflation valve (Figure 8). The location chosen should provide protection so the valve will not be damaged but be accessible for the air inflation chuck. Recommended location is in the wheel well or lower body ahead of rear wheel. One on each side provides ease of filling, checking and measuring body height to compensate for side to side lean and front to rear sag.

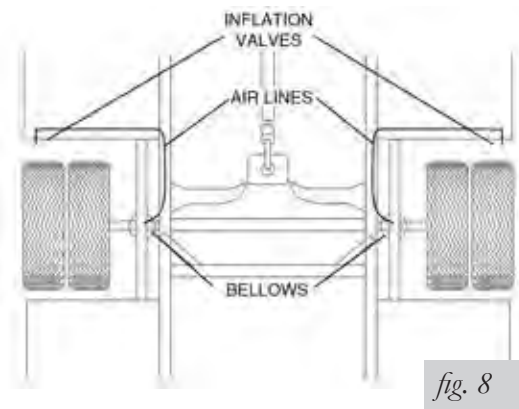
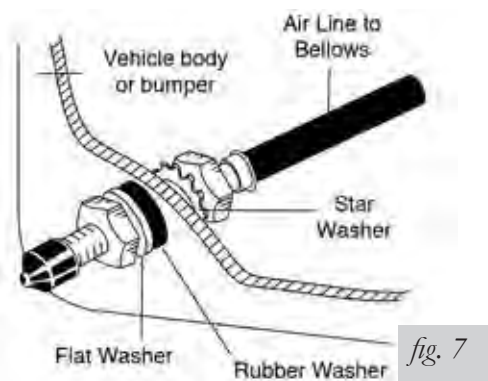

- B. Measure from selected location inboard along frame rail to center of jounce bumper bracket. Measure this same distance from each pre-installed inflation valve on the air line.



- C. Using a standard tube cutter, a razor blade, or very sharp knife to cut the air line. A clean square cut will ensure against leaks. Then cut air line off squarely.
- D. Slide a thermal sleeve onto air line from the cut end on the tail pipe side on vehicles.
- E. Push cut end of air line into the air fitting as far as it will go (9/16"). This is a push to connect fitting on the air line. You will hear or feel a definite "click."
- F. Slide the thermal sleeve down to the air fitting.
- G. Route the air line from the bellows to the pre-determined inflation valve location. Insure that it is protected from the direct heat of the exhaust system and kept away from sharp edges. Caution should be taken not to kink or bend the air line. Secure along frame with the nylon ties supplied with this kit (Figure 8).
- H. Drill two 5/16" holes, and install inflation valves and washers (Figure 7). Then inflate the bellows and check the fittings for air leaks with a solution of soap and water.
- I. Raise vehicle and remove safety jack stands. Lower vehicle to ground.
- J. This now completes the installation. Before proceeding, check once again to be sure you have proper clearance around the bellows. With a load on your vehicle and the air springs inflated, you must have sufficient clearance all around the bellows.

## CHECKING FOR LEAKS

1. Inflate the air spring to 60 p.s.i.
2. Spray all connections and the inflation valves with a solution of 1/5 liquid dish soap and 4/5 water to check for leaks. You should be able to spot leaks easily by looking for bubbles in the soapy water.
3. After the test, deflate the springs to the minimum pressure required to restore the Normal Ride Height, but not less than 5 p.s.i.

### NOTE

*Check the air pressure again after 24 hours. A 2 to 4 p.s.i. loss after initial installation is normal. Retest for leaks if the loss is more than 5 lbs.*

## FIXING LEAKS

1. If there is a problem with the swivel fitting, then:
  - a. Check the air line connection by deflating the spring and removing the line by pulling the collar against the fitting and pulling firmly on the air line. Trim 1" off the end of the air line. Be sure the cut is clean and square. Reinsert the air line into the push-to-connect fitting.
  - b. Check the threaded connection by tightening the swivel fitting another 1/2 turn. If it still leaks, deflate the air spring, remove the fitting, and re-coat the threads with thread sealant. Reinstall by hand tightening as much as possible, then use a wrench for an additional two turns.
2. If there is a problem with the inflation valve, then:
  - a. Check the valve core by tightening it with a valve core tool.
  - b. Check the air line connection by removing the air line from the barbed type fitting.

### CAUTION

**DO NOT CUT IT OFF. AS THIS WILL USUALLY NICK THE BARB AND RENDER THE FITTING USELESS. CUT AIR LINE OFF A FEW INCHES IN FRONT OF THE FITTING AND USE A PAIR OF PLIERS OR VISE-GRIPS TO PULL/TWIST THE AIR LINE OFF THE FITTING.**

3. If the preceding steps have not resolved the problem, call Air Lift Technical Service at 1-800-248-0892 for assistance.

# Before Operating

## INSTALLATION CHECKLIST (To be completed by installer)

- Clearance test — Inflate the air springs to 60 PSI and ensure there is at least ½” clearance around each bellow, away from anything that might rub against them. Be sure to check the tire, brake drum, frame, shock absorbers and brake cables.
- Leak test before road test — Inflate the air springs to 60 PSI, check all connections for leaks with a soapy water solution. See page 12 for tips on how to spot leaks. All leaks must be eliminated before the vehicle is road tested.
- Heat test — Be sure there is sufficient clearance from any heat sources — at least 6” for air springs and air lines. If a heat shield was included in the kit, install it. If there is no heat shield, but one is required, call (800) 248-0892.
- Fastener test — Recheck all bolts for proper torque. Axle clamp bar carriage bolt lock nuts should be torqued to 16 ft/lbs. Re-torque after 100 miles.
- Road test — The vehicle should be road tested after the preceding tests. Inflate the air springs to 25 PSI (50 PSI if the vehicle is loaded). Drive the vehicle 10 miles and recheck for clearance, loose fasteners and air leaks.
- Operating instructions — If professionally installed, the installer should review the Product Use, Maintenance and Servicing section on page 14 with the owner. Be sure to provide the owner with all of the paperwork which came with the kit.

**Technician's Signature** \_\_\_\_\_

**Date** \_\_\_\_\_

## POST-INSTALLATION CHECKLIST

- Overnight leak down test — Recheck air pressure after the vehicle has been used for 24 hours. If the pressure has dropped more than 5 PSI, then there is a leak that must be fixed. Either fix the leak yourself or return to the installer for service.
- Air pressure requirements — Regardless of load, the air pressure should always be adjusted to maintain ride height at all times.
- Thirty day or 500 mile test — Recheck the air spring system after 30 days or 500 miles, whichever comes first. If any part shows signs of rubbing or abrasion, the source should be identified and moved, if possible. If it is not possible to relocate the cause of the abrasion, the air spring may need to be remounted. If professionally installed, the installer should be consulted. Check all fasteners for tightness.

# Product Use, Maintenance and Servicing

Minimum Pressure	Maximum Air Pressure
20 PSI	100 PSI
FAILURE TO MAINTAIN CORRECT MINIMUM PRESSURE (OR PRESSURE PROPORTIONAL TO LOAD), BOTTOMING OUT, OVER-EXTENSION OR RUBBING AGAINST ANOTHER COMPONENT WILL VOID THE WARRANTY.	

## MAINTENANCE GUIDELINES

### NOTE

*By following the steps below, vehicle owners will obtain the longest life and best results from their air springs.*

1. Check the air pressure weekly.
2. Always maintain normal ride height. Never inflate beyond 100 PSI.
3. If you develop an air leak in the system, use a soapy water solution (1/5 liquid dish soap and 4/5 water) to check all air line connections and the inflation valve core before deflating and removing the air spring.



### CAUTION

FOR YOUR SAFETY AND TO PREVENT POSSIBLE DAMAGE TO YOUR VEHICLE, DO NOT EXCEED MAXIMUM GROSS VEHICLE WEIGHT RATING (GVWR), AS INDICATED BY THE VEHICLE MANUFACTURER. ALTHOUGH YOUR AIR SPRINGS ARE RATED AT A MAXIMUM INFLATION PRESSURE OF 100 P.S.I., THE AIR PRESSURE ACTUALLY NEEDED IS DEPENDANT ON YOUR LOAD AND GVWR.

4. Loaded vehicles require at least 25 PSI or more. A “loaded vehicle” refers to a vehicle with a heavy bed load, a trailer, or both. As discussed above, never exceed GVWR, regardless of air spring, air pressure, or other load assist. The springs in this kit will support approximately 40 lbs. of load (combined on both springs) for each 1 PSI of pressure. The required air pressure will vary depending on the state of the original suspension. Operating the vehicle below the minimum air spring pressure will void the Air Lift warranty.
5. When increasing load, always adjust the air pressure to maintain the normal ride height. Increase or decrease pressure from the system as necessary to attain normal ride height for optimal ride and handling. Remember that loads carried behind the axle (including tongue loads) require more leveling force (pressure) than those carried directly over the axle.
6. Always add air to springs in small quantities, checking the pressure frequently.
7. Should it become necessary to raise the vehicle by the frame, make sure the system is at minimum pressure (20 PSI) to reduce the tension on the suspension/brake components. Use of on board leveling systems do not require deflation or disconnection.
8. Periodically check the air spring system fasteners for tightness. Also, check the air springs for any signs of rubbing. Realign if necessary.
9. On occasion, give the air springs a hard spray with a garden hose in order to remove mud, sand, gravel or other abrasive debris.

## TROUBLESHOOTING GUIDE

1. Leak test the air line connections, the threaded connection into the air spring, and all fittings in the control system.
2. Inspect the air lines to be sure none are pinched. Tie straps may be too tight. Loosen or replace the strap and replace leaking components.
3. Inspect the air line for holes and cracks. Replace as needed.

4. Look for a kink or fold in the air line. Reroute as needed.

If the preceding steps do not solve the problem, it is possibly caused by a failed air spring — either a factory defect or an operating problem. Please call Air Lift at (800) 248-0892 for assistance.

## FREQUENTLY ASKED QUESTIONS

### Q. Will installing air springs increase the weight ratings of a vehicle?

No. Adding air springs will not change the weight ratings (GAWR, GCWR and/or GVWR) of a vehicle. Exceeding the GVWR is dangerous and voids the Air Lift warranty.

### Q. Is it necessary to keep air in the air springs at all times and how much pressure will they need?

The minimum air pressure should be maintained at all times. The minimum air pressure keeps the air spring in shape, ensuring that it will move throughout its travel without rubbing or wearing on itself.

### Q. Is it necessary to add a compressor system to the air springs?

No. Air pressure can be adjusted with any type of compressor as long as it can produce sufficient pressure to service the springs. Even a bicycle tire pump can be used, but it's a lot of work.

### Q. How long should air springs last?

If the air springs are properly installed and maintained they can last indefinitely.

### Q. Will raising the vehicle on a hoist for service work damage the air springs?

No. The vehicle can be lifted on a hoist for short-term service work such as tire rotation or oil changes. However, if the vehicle will be on the hoist for a prolonged period of time, support the axle with jack stands in order to take the tension off of the air springs.

## TUNING THE AIR PRESSURE

Pressure determination comes down to three things — level vehicle, ride comfort, and stability.

### 1. Level vehicle

If the vehicle's headlights are shining into the trees or the vehicle is leaning to one side, then it is not level (fig. 2.1). Raise the air pressure to correct either of these problems and level the vehicle.

### 2. Ride comfort

If the vehicle has a rough or harsh ride it may be due to either too much pressure or not enough (fig. 2.2). Try different pressures to determine the best ride comfort.

### 3. Stability

Stability translates into safety and should be the priority, meaning the driver may need to sacrifice a perfectly level and comfortable ride. Stability issues include roll control, bounce, dive during braking and sponginess (fig. 2.3). Tuning out these problems usually requires an increase in pressure.

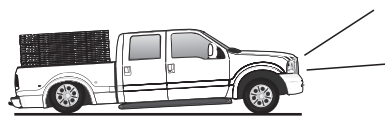

Bad headlight aim *fig. 2.1*



Rough ride *fig. 2.2*

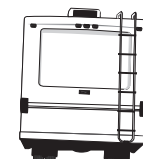

Sway and body roll *fig. 2.3*

## GUIDELINES FOR ADDING AIR

1. Start with the vehicle level or slightly above.
2. When in doubt, always add air.
3. If the front of the vehicle dives while braking, increase the pressure in the front air bags, if equipped.
4. If it is ever suspected that the air bags have bottomed out, increase the pressure (fig. 2.4).
5. Adjust the pressure up and down to find the best ride.
6. If the vehicle rocks and rolls, adjust the air pressure to reduce movement.
7. It may be necessary to maintain different pressures on each side of the vehicle. Loads such as water, fuel, and appliances will cause the vehicle to be heavier on one side (fig. 2.5). As much as a 50 PSI difference is not uncommon.



Bottoming out

*fig. 2.4*

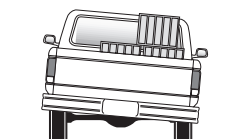

Unlevel

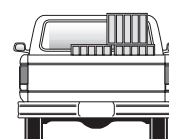

Level

*fig. 2.5*

# Choosing the Right On-Board Air Compressor System

**60 DAY** NO QUESTIONS ASKED, MONEY-BACK GUARANTEE

**TWO YEAR** COMPRESSOR SYSTEM WARRANTY

Add an on-board air compressor system to inflate and deflate your air springs with the touch of a button — from inside or outside of the vehicle.

- For convenient, on-the-go control of your air springs, add an Air Lift on-board air compressor system.
- Air Lift on-board air compressor systems eliminate the search for gas stations that have a working compressor, saving you time, energy and money.
- All systems include a compressor, controller and all parts needed for easy installation.

**1. Choose single or dual path inflation (see illustrations at right)**

**2. Choose wireless or analog control**

- **Wireless:** Control your air springs from inside or outside the vehicle. Easiest installation - no wires to the cab.
- **Analog:** In-cab control of your air springs. Economically priced.

**3. Choose heavy or standard duty compressor**

- **Standard duty:** A standard duty compressor will work well for most customers who use their system on an intermittent basis.
- **Heavy duty:** For daily use, consider the heavy duty compressor - it inflates faster and more quietly than the standard compressor.

Visit [www.airliftcompany.com](http://www.airliftcompany.com) for more detailed info on compressor systems.

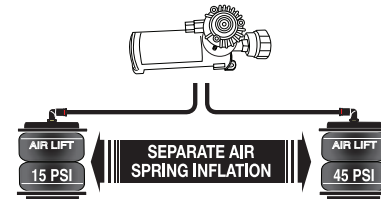

**Dual path systems** Air springs are controlled separately to allow for different air pressure from side-to-side. Perfect for uneven or top-heavy loads.

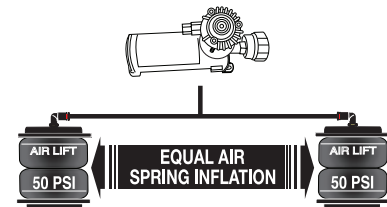

**Single path systems** Two springs will inflate at the same time. Good for loads that are evenly distributed from left-to-right or front-to-back.

W I R E L E S S

A N A L O G

DUAL PATH

**WirelessAIR™**

OUR PREMIUM SYSTEM!

- Easy installation
- Includes heavy duty compressor



P/N 72000

SINGLE PATH

**WirelessONE™**

- Easy installation
- Includes standard duty compressor



P/N 25870

**LoadCONTROLLER™**

**Dual**

Compact, economically priced control.



P/N Standard Duty Compressor 25850; P/N Heavy Duty Compressor 25854

**LoadCONTROLLER™**

**Single**

Compact, economically priced control.



P/N Standard Duty Compressor 25852; P/N Heavy Duty Compressor 25856



# Warranty and Returns Policy

Air Lift Company warrants its products, for the time periods listed below, to the original retail purchaser against manufacturing defects when used on catalog-listed applications on cars, vans, light trucks and motorhomes under normal operating conditions for as long as Air Lift manufactures the product. The warranty does not apply to products that have been improperly applied, improperly installed, used in racing or off-road applications, used for commercial purposes, or which have not been maintained in accordance with installation instructions furnished with all products. The consumer will be responsible for removing (labor charges) the defective product from the vehicle and returning it, transportation costs prepaid, to the dealer from which it was purchased or to Air Lift Company for verification.

Air Lift will repair or replace, at its option, defective products or components. A minimum \$10.00 shipping and handling charge will apply to all warranty claims. Before returning any defective product, you must call Air Lift at (800) 248-0892 in the U.S. and Canada (elsewhere, (517) 322-2144) for a Returned Materials Authorization (RMA) number. Returns to Air Lift can be sent to: Air Lift Company • 2727 Snow Road • Lansing, MI • 48917.

Product failures resulting from abnormal use or misuse are excluded from this warranty. The loss of use of the product, loss of time, inconvenience, commercial loss or consequential damages is not covered. The consumer is responsible for installation/reinstallation (labor charges) of the product. Air Lift Company reserves the right to change the design of any product without assuming any obligation to modify any product previously manufactured.

This warranty gives you specific legal rights and you may also have other rights that vary from state-to-state. Some states do not allow limitations on how long an implied warranty lasts or allow the exclusion or limitation of incidental or consequential damages. The above limitation or exclusion may not apply to you. There are no warranties, expressed or implied including any implied warranties of merchantability and fitness, which extend beyond this warranty period. There are no warranties that extend beyond the description on the face hereof. Seller disclaims the implied warranty of merchantability. (Dated proof of purchase required.)

<b>Air Lift 1000</b> .....	<b>Lifetime Limited</b>	<b>LoadController/Dual</b> .....	<b>2 Year Limited</b>
<b>RideControl</b> .....	<b>Lifetime Limited</b>	<b>Load Controller (I)</b> .....	<b>2 Year Limited</b>
<b>LoadLifter 5000*</b> .....	<b>Lifetime Limited</b>	<b>Load Controller (II)</b> .....	<b>2 Year Limited</b>
<b>LoadLifter 5000 Ultimate</b> ...	<b>Lifetime Limited</b>	<b>SmartAir</b> .....	<b>2 Year Limited</b>
<b>SlamAir</b> .....	<b>Lifetime Limited</b>	<b>Wireless AIR</b> .....	<b>2 Year Limited</b>
<b>AirCell</b> .....	<b>Lifetime Limited</b>	<b>WirelessONE</b> .....	<b>2 Year Limited</b>
<b>Air Lift Performance**</b> .....	<b>1 Year Limited</b>	<b>Other Accessories</b> .....	<b>2 Year Limited</b>
<b>LoadController/Single</b> .....	<b>2 Year Limited</b>		

*\*formerly SuperDuty*  
*\*\*formerly LifeSTYLE & Performance, EasyStreet*

## Replacement Information

If you need replacement parts, contact the local dealer or call Air Lift customer service at (800) 248-0892. Most parts are immediately available and can be shipped the same day.

**Contact Air Lift Company customer service at (800) 248-0892, first if:**

- Parts are missing from the kit.
- Need technical assistance on installation or operation.
- Broken or defective parts in the kit.
- Wrong parts in the kit.
- Have a warranty claim or question.

**Contact the retailer where the kit was purchased:**

- If it is necessary to return or exchange the kit for any reason.
- If there is a problem with shipping if shipped from the retailer.
- If there is a problem with the price.

## Contact Information

If you have any questions, comments or need technical assistance, contact our customer service department by calling (800) 248-0892, Monday through Friday. For calls from outside the USA or Canada, our local number is (517) 322-2144.

For inquiries by mail, our address is PO Box 80167, Lansing, MI 48908-0167. Our shipping address for returns is 2727 Snow Road, Lansing, MI 48917.

You may also contact us anytime by e-mail at [sales@airliftcompany.com](mailto:sales@airliftcompany.com) or on the web at [www.airliftcompany.com](http://www.airliftcompany.com).









## Need Help?

Contact our customer service department by calling (800) 248-0892, Monday through Friday. For calls from outside the USA or Canada, our local number is (517) 322-2144.

**Register your warranty online at  
[www.airliftcompany.com/warranty](http://www.airliftcompany.com/warranty)**



*Thank you for purchasing Air Lift products — the professional installer's choice!*

Air Lift Company • 2727 Snow Road • Lansing, MI 48917 or PO Box 80167 • Lansing, MI 48908-0167  
Toll Free (800) 248-0892 • Local (517) 322-2144 • Fax (517) 322-0240 • [www.airliftcompany.com](http://www.airliftcompany.com)

Printed in  
the USA