

Air Lift™
PERFORMANCE

Kit 75587

Scion tc

front application

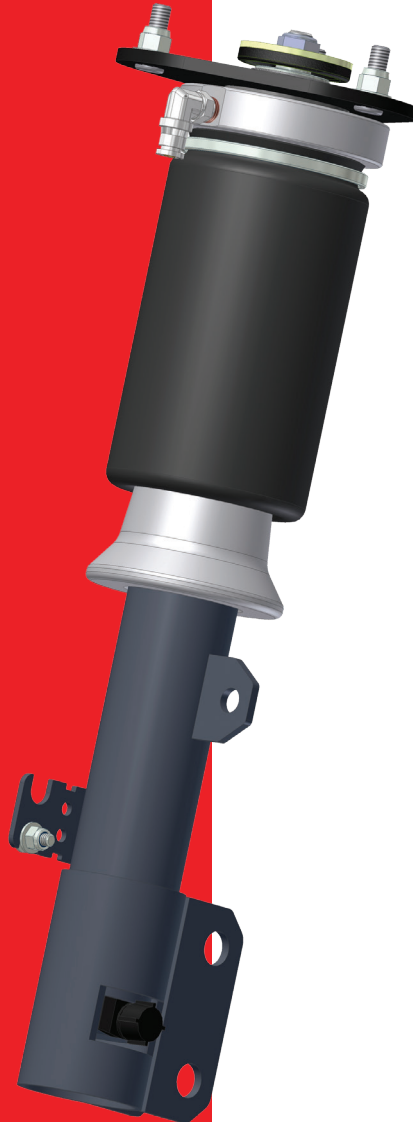

AIR LIFT
PERFORMANCE™

INSTALLATION GUIDE

For maximum effectiveness and safety, please read these instructions completely before proceeding with installation.

Failure to read these instructions can result in an incorrect installation.

TABLE OF CONTENTS

Introduction	2
Notation Explanation	2
Important Safety Notices	2
Installation Diagram	3
Hardware List	3
Tools List	3
Installing the Air Suspension	4
Preparing the Vehicle	4
Removing the Strut	4
Installing the New Strut Assembly	6
Aligning the Vehicle	6
Before Operating	8
Installation Checklist	9
Product Use, Maintenance and Servicing	10
Suggested Driving and Maximum Air Pressures	10
Maintaining and Operating	10
Troubleshooting Guide	10
Frequently Asked Questions	11
Tuning the Air Pressure	11
Checking for Leaks	11
Fixing Leaks	11
Warranty & Returns Policy	12
Replacement Information	13
Contact Information	13

Introduction

The purpose of this publication is to assist with the installation, maintenance and troubleshooting of this Scion Air Lift Performance kit.

It is important to read and understand the entire installation guide before beginning installation or performing any maintenance, service or repair. The information includes a hardware list, tool list, step-by-step installation information, maintenance tips, safety information and a troubleshooting guide.

Air Lift Company reserves the right to make changes and improvements to its products and publications at any time. For the latest version of this manual, contact Air Lift Company at (800) 248-0892 or visit our website at www.airliftcompany.com.

NOTATION EXPLANATION

Hazard notations appear in various locations in this publication. Information which is highlighted by one of these notations must be observed to help minimize risk of personal injury or possible improper installation which may render the vehicle unsafe. Notes are used to help emphasize areas of procedural importance and provide helpful suggestions. The following definitions explain the use of these notations as they appear throughout this guide.



DANGER

INDICATES IMMEDIATE HAZARDS WHICH WILL RESULT IN SEVERE PERSONAL INJURY OR DEATH.



WARNING

INDICATES HAZARDS OR UNSAFE PRACTICES WHICH COULD RESULT IN SEVERE PERSONAL INJURY OR DEATH.



CAUTION

INDICATES HAZARDS OR UNSAFE PRACTICES WHICH COULD RESULT IN DAMAGE TO THE MACHINE OR MINOR PERSONAL INJURY.

NOTE

Indicates a procedure, practice or hint which is important to highlight.

IMPORTANT SAFETY NOTICES

The installation of this kit does not alter the Gross Vehicle Weight Rating (GVWR) or payload of the vehicle. Check your vehicle's owner's manual and do not exceed the maximum load listed for your vehicle.

Gross Vehicle Weight Rating: The maximum allowable weight of the fully loaded vehicle (including passengers and cargo). This number — along with other weight limits, as well as tire, rim size and inflation pressure data — is shown on the vehicle's Safety Compliance Certification Label.

Payload: The combined, maximum allowable weight of cargo and passengers that the vehicle is designed to carry. Payload is GVWR minus the Base Curb Weight.



WARNING

DO NOT INFLATE AIR SPRINGS WHILE OFF OF THE VEHICLE. DAMAGE TO ASSEMBLY MAY RESULT AND VOID WARRANTY.



CAUTION

DO NOT WELD TO, OR MODIFY LIFESTYLE STRUTS/SHOCKS IN ANY WAY. DAMAGE TO UNIT MAY OCCUR AND WILL VOID WARRANTY.

Installation Diagram

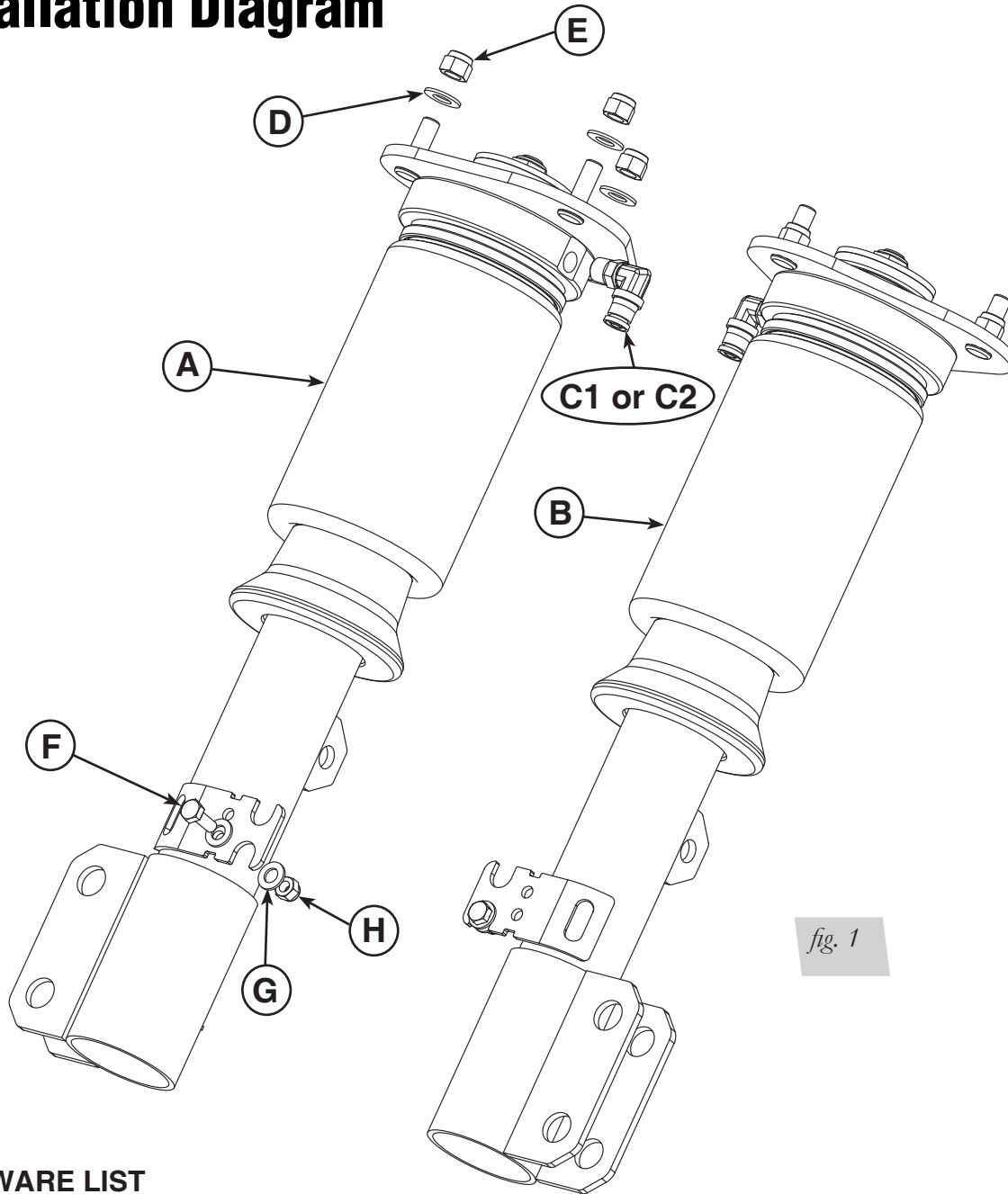

HARDWARE LIST

Item	Part #	Description	Qty
A	35252	Strut Assembly - Right	1
B	35359	Strut Assembly - Left.....	1
C1	21851	Fitting - 1/4" NPT X 3/8" PTC, Elbow ..	2
C2	21779	Fitting - 1/4NPT X 1/4PTC, Elbow	2
D	18444	3/8" Flat Washer	6
E	18435	3/8" - 16 Nyloc Nut.....	6
F	17175	1/4" - 20 X .75 Bolt.....	2
G	18501	Flat Washer.....	4
H	18425	1/4" - 20 Nyloc Nut.....	2

TOOLS LIST

Description
Jack or hoist
Jack stands
Metric Wrenches
Standard Wrenches
Torque Wrench



Missing or damaged parts? Call Air Lift customer service at (800) 248-0892 for a replacement part.

Installing the Air Suspension

PREPARING THE VEHICLE

1. Elevate the vehicle and support the body with a hoist or jack stands.
2. Remove the front wheels.

REMOVING THE STRUT

NOTE

This procedure works for left and right strut.

1. Remove cap from the wiper arms, mark the position of the arm to the inner spindle. Unthread both wiper arm nuts and remove both arms from the vehicle (fig. 2).
2. Carefully remove the hood cowl seal. Remove all push-pins from the cowl and remove left and right cowl portions (fig. 2).

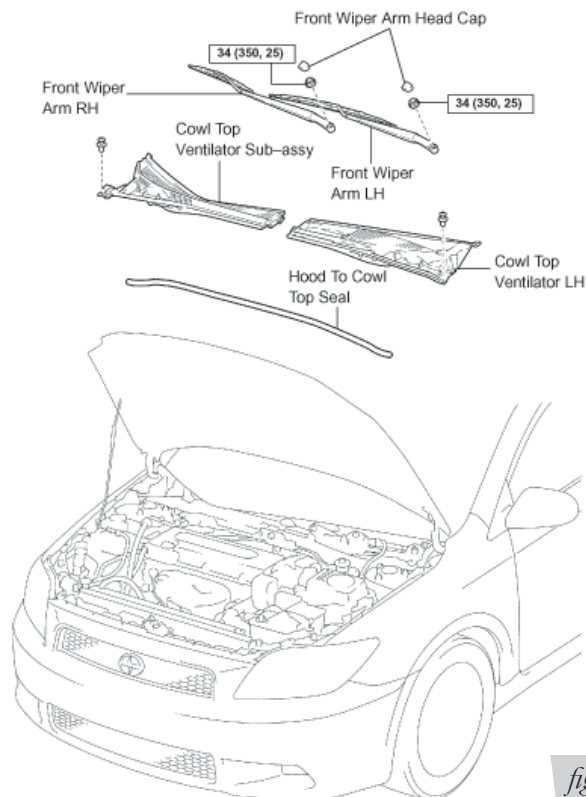

fig. 2

3. Disconnect the sway bar link from the strut. Save nut for re-installation. (fig. 3)

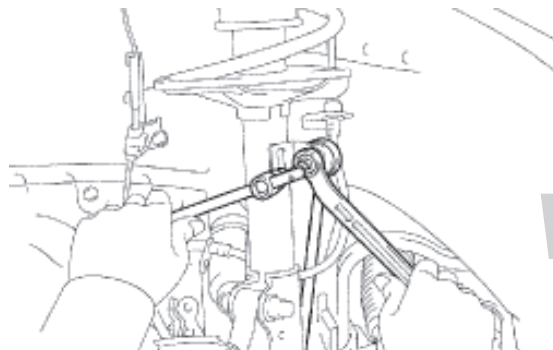

fig. 3

4. Unbolt/unclip the speed sensor and brake line from the strut. Discard bolt. (fig. 4)

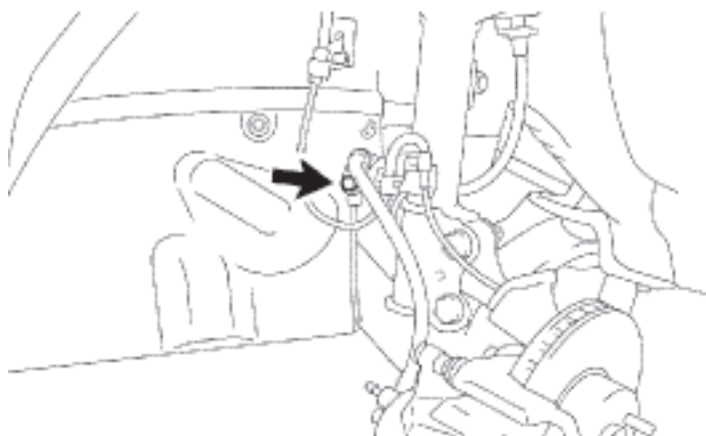

fig. 4

5. Support the hub assembly. Remove the three upper strut mount bolts within the engine compartment (fig. 5).

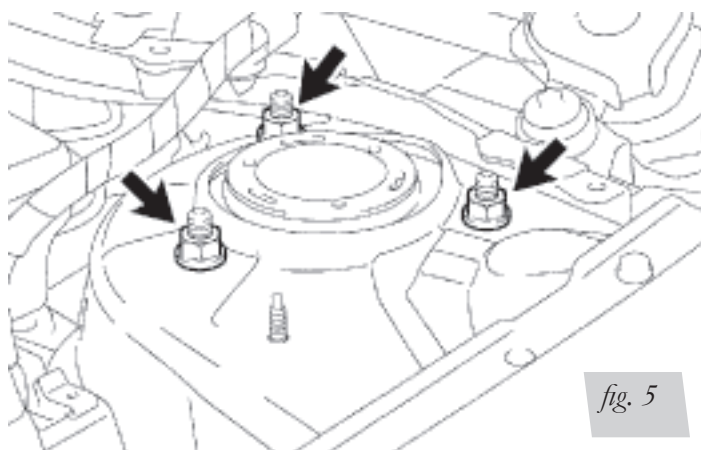

fig. 5

6. Clearly mark the location of the lower spindle bolts before removing. Unbolt the lower spindle mounting bolts and save for later re-installation (fig. 6).

NOTE

These bolts are used for stock camber adjustment. Switching the bolts may change camber angle depending on stock set up. Further camber adjustment can be achieved by purchasing different factory bolts from your Scion dealership.

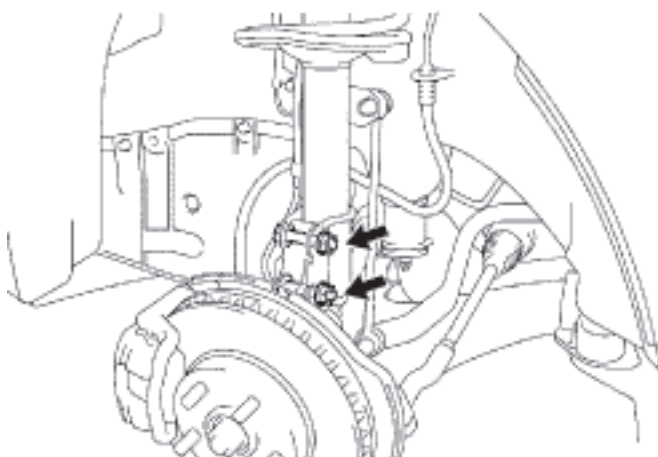

fig. 6

INSTALLING THE NEW STRUT ASSEMBLY

1. Prior to installing the strut, attach the air fitting (21851) provided to the threaded port at the top of the air spring (fig. 7). Seal with Teflon tape.
2. Apply Teflon tape or thread sealant to the fitting threads and install into the top of the air spring. Thread fitting in hand tight and torque 1-3/4 turns beyond hand tight.

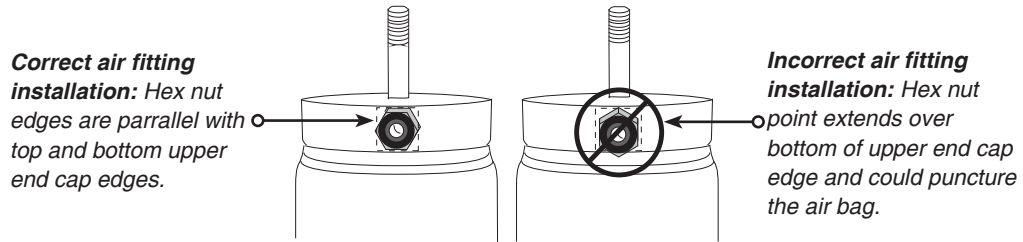

fig. 7

3. Before inserting the new strut assembly, look at the top of the supplied upper mount. Left and right struts are indicated on this mount with either a large “R” or “L” along with an arrow. This arrow must point toward the front of the vehicle (fig. 8). Insert the appropriate strut into the pocket, align the upper bracket with the arrow pointing to the front of the vehicle, and reinstall the upper mount nuts. Torque to 37 Nm (27 ft./lbs.).

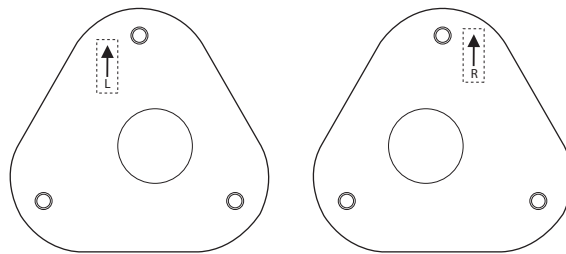

fig. 8

4. Install lower mounting bolts. Torque to 240 Nm (177 ft./lbs.).
5. Reattach the speed sensor and brake line to the tab. Use the supplied bolt (17175), washers (18444) and nyloc nut (18425), to securely attach through the lower hole of the tab.
6. Reattach the swaybar link. Torque to 74 Nm (55 ft./lbs.).
7. Install the left and right cowl, snapping the center section together. Insert the push-pins through the cowl into the body. Reattach the cowl seat.
8. Take the wiper arms and align with the previous mounting mark. Securely fasten the wiper arms in place and clip the wiper caps back on.
9. Install wheel and torque to 103 Nm (76 ft./lbs.).

ALIGNING THE VEHICLE

1. Using the control system, set the vehicle height to the new custom ride height.
2. If the custom ride height is lower than stock, we recommend loosening all pivot points (bolts, nuts) on any control arm, strut arm or radius rod that contains bushings. Once they have been loosened, re-torque to stock specifications (fig. 9).

NOTE

It may be necessary to cycle the suspension to loosen the bushing up from its mount. This will help re-orient the bushing at its new position based on the custom ride height.

Description	Nm	ft./lbs.
Lower Control Arm to Crossmember bolt	137	101
Upper Mount Nuts	37	27
Sway Bar Link	74	55
Brake Line Tab	5	4
Wheel Mounting Nuts	103	76

fig. 9

3. To adjust camber, reference your vehicle bolts to fig. 10 or fig. 11 depending on the direction of desired adjustment. "Installed Bolt 1" is the upper and "Installed Bolt 2" is the lower bolt. Determine adjustment letter and refer to fig. 12 for bolt replacement.

The table below will adjust camber positive (fig. 10).

NOTE

Replace one bolt at a time.

Installed Bolt \ Adjusting Value	1							
		90105-17008	90105-17008	90105-17008	90105-17008	90105-17009	90105-17010	90105-17011
2								
		90105-17008	90105-17009	90105-17010	90105-17011	90105-17011	90105-17011	90105-17011
-1°30' to -1°15'								G
-1°15' to -1°00'							G	A
-1°00' to -0°45'					G	A	A	B
-0°45' to -0°30'				G	A	B	B	C
-0°30' to -0°15'			G	A	B	C	C	D
-0°15' to 0°		G	A	B	C	D	D	E
0° to 0°15'	A	B	C	D	E	F	F	
0°15' to 0°30'	B	C	D	E	F			
0°30' to 0°45'	C	D	E	F				
0°45' to 1°00'	D	E	F					
1°00' to 1°15'	E	F						
1°15' to 1°30'	F							

fig. 10

The table below will adjust camber negative (fig. 11).

NOTE

Replace one bolt at a time.

Installed Bolt \ Adjusting Value	1							
		90105-17008	90105-17008	90105-17008	90105-17008	90105-17009	90105-17010	90105-17011
2								
		90105-17008	90105-17009	90105-17010	90105-17011	90105-17011	90105-17011	90105-17011
-1°30' to -1°15'	F							
-1°15' to -1°00'	E	F						
-1°00' to -0°45'	D	E	F					
-0°45' to -0°30'	C	D	E	F				
-0°30' to -0°15'	B	C	D	E	F			
-0°15' to 0°	A	B	C	D	E	F		
0° to 0°15'		G	A	B	C	D	E	
0°15' to 0°30'			G	A	B	C	D	
0°30' to 0°45'				G	A	B	C	
0°45' to 1°00'					G	A	B	
1°00' to 1°15'						G	A	
1°15' to 1°30'							G	

fig. 11















	A	B	C	D	E	F	G
1	 90105-17008	 90105-17008	 90105-17008	 90105-17009	 90105-17010	 90105-17011	 90105-17008
2	 90105-17009	 90105-17010	 90105-17011	 90105-17011	 90105-17011	 90105-17011	 90105-17008

fig. 12

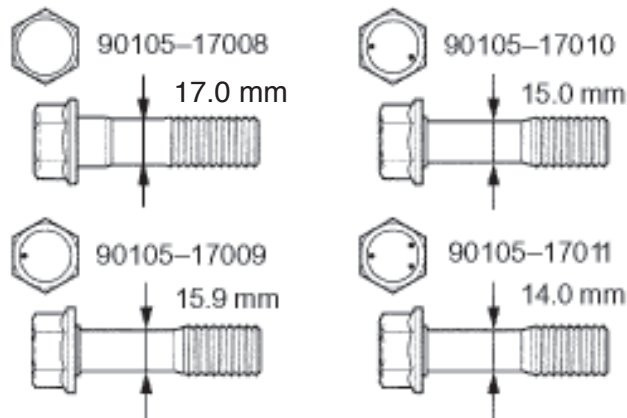

fig. 13

Before Operating

1. Some struts for this vehicle come with a nine-position damping dial for added adjustability (fig. 14). If not, proceed to 2.

Before driving your vehicle, set the new struts to their highest setting by turning the black dial on the shaft of the strut as far as it will go to the right (position 9).

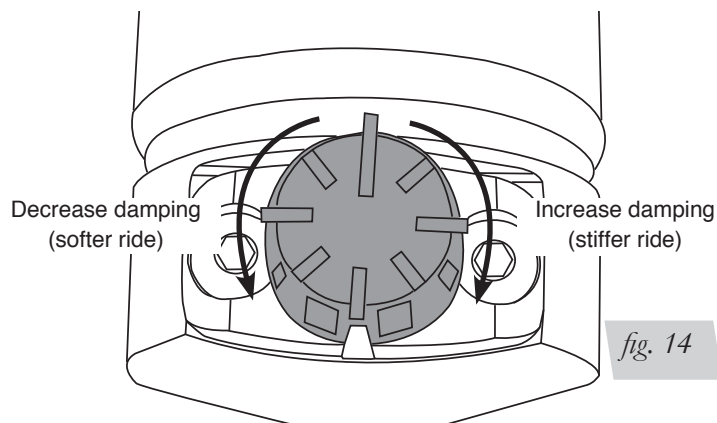

fig. 14

2. Next, completely deflate and reinflate the air bags 2-3 times. This procedure will purge any trapped air in the dampers and allow for maximum performance. For ride performance and the most versatility, Lifestyle recommends setting the strut dial (if equipped) to position 6 or higher.

CAUTION

MAKE SURE THE FRONT WHEELS ARE STRAIGHT WHEN DEFLATING AND REINFLATING AIR BAGS.

3. Inflate and deflate the system (do not exceed 125 PSI) to check for clearance or binding

issues. With the air springs deflated, check clearances on everything so as not to pinch brake lines, vent tubes, etc. Clear lines if necessary.

4. Inflate the air springs to 75PSI - 90PSI and check all connections for leaks.
5. Air Lift part #27669 or #27671, AutoPilot V2 Air Management System, is highly recommended for this product.
6. Please continue by reading the Product Use, Maintenance and Servicing section.

INSTALLATION CHECKLIST

- Clearance test — Inflate the air springs to 75-90 PSI and make sure there is at least ½” clearance from anything that might rub against each sleeve. Be sure to check the tire, brake drum, frame, shock absorbers and brake cables.
- Leak test before road test — Inflate the air springs to 75PSI - 90PSI and check all connections for leaks. All leaks must be eliminated before the vehicle is road tested.
- Heat test — Be sure there is sufficient clearance from heat sources, at least 6” for air springs and air lines. If a heat shield was included in the kit, install it. If there is no heat shield, but one is required, call Air Lift customer service at (800) 248-0892.
- Fastener test — Recheck all bolts for proper torque.
- Road test — The vehicle should be road tested after the preceding tests. Inflate the springs to recommended driving pressures. Drive the vehicle 10 miles and recheck for clearance, loose fasteners and air leaks.
- Operating instructions — If professionally installed, the installer should review the operating instructions with the owner. Be sure to provide the owner with all of the paperwork that came with the kit.

Technician's Signature _____

Date _____

POST-INSTALLATION CHECKLIST

- Overnight leak down test — Recheck air pressure after the vehicle has been used for 24 hours. If the pressure has dropped more than 5 PSI, then there is a leak that must be fixed. Either fix the leak yourself or return to the installer for service.
- Air pressure requirements — I understand the air pressure requirements of my air spring system. Regardless of load, the air pressure should always be adjusted to maintain adequate ride height at all times while driving.
- Thirty day or 500 mile test — I understand that I must recheck the air spring system after 30 days or 500 miles, whichever comes first. If any part shows signs of rubbing or abrasion, the source should be identified and moved, if possible. If it is not possible to relocate the cause of the abrasion, the air spring may need to be remounted. If professionally installed, the installer should be consulted. Check all fasteners for tightness.

Product Use, Maintenance and Servicing

Suggested Driving Air Pressure	Maximum Air Pressure
75 PSI	125 PSI
FAILURE TO MAINTAIN ADEQUATE MINIMUM PRESSURE (OR PRESSURE PROPORTIONAL TO LOAD) WILL RESULT IN BOTTOMING OUT, OVER-EXTENSION OR RUBBING AGAINST ANOTHER COMPONENT AND WILL VOID THE WARRANTY .	

MAINTENANCE GUIDELINES

NOTE

By following these steps, vehicle owners will obtain the longest life and best results from their air spring.

1. Check the air pressure before driving.
2. Never inflate beyond 125 PSI.
3. If you develop an air leak in the system, use a soapy water solution to check all air line connections, before deflating and removing the spring.
4. When increasing load, always adjust the air pressure to maintain normal ride height. Increase or decrease pressure from the system as necessary to attain normal ride height for optimal ride and handling. Remember that loads carried behind the axle (including tongue loads) require more leveling force (pressure) than those carried directly over the axle.

CAUTION

FOR YOUR SAFETY AND TO PREVENT DAMAGE TO YOUR VEHICLE, DO NOT EXCEED MAXIMUM GROSS VEHICLE WEIGHT RATING (GVWR), AS INDICATED BY THE VEHICLE MANUFACTURER. ALTHOUGH YOUR AIR SPRINGS ARE RATED AT A MAXIMUM INFLATION PRESSURE OF 125 PSI, THE AIR PRESSURE ACTUALLY NEEDED IS DEPENDENT ON YOUR LOAD.

5. Always add air to the springs in small quantities, checking the pressure frequently. Sleeves require less air volume than a tire and inflate quickly.
6. Should it become necessary to raise the vehicle by the frame, make sure the control system is turned off before lifting.

Troubleshooting Guide

1. Leak test the air line connections, the threaded connection into the air spring, and all fittings in the control system.
2. Inspect the air lines to be sure none are pinched. Tie straps may be too tight. Loosen or replace the strap and replace leaking components.
3. Inspect the air line for holes and cracks. Replace as needed.
4. Look for a kink or fold in the air line. Reroute as needed.

If the preceding steps do not solve the problem, it is possibly caused by a failed air spring — either a factory defect or an operating problem. Please call Air Lift at (800) 248-0892 for assistance.

Frequently Asked Questions

Q. Will installing air springs increase the weight ratings of a vehicle?

No. Adding air springs will not change the weight ratings (GAWR, GCWR and/or GVWR) of a vehicle. Exceeding the GVWR is dangerous and voids the Air Lift warranty.

Q. How long should air springs last?

If the air springs are properly installed and maintained they can last indefinitely.

Q. Will raising the vehicle on a hoist for service work damage the air springs?

No. The vehicle can be lifted on a hoist for short-term service work such as tire rotation or oil changes. However, if the vehicle will be on the hoist for a prolonged period of time, support the axle with jack stands in order to take the tension off of the air springs.

Tuning the Air Pressure

Pressure determination comes down to three things — level vehicle, ride comfort, and stability.

1. Level vehicle

If the vehicle's headlights are shining into the trees or the vehicle is leaning to one side, then it is not level. Raise the air pressure to correct either of these problems and level the vehicle.

2. Ride comfort

If the vehicle has a rough or harsh ride it may be due to either too much pressure or not enough. Try different pressures to determine the best ride comfort. See Air Lift suggested driving air pressure.

3. Stability

Stability translates into safety and should be the priority, meaning the driver may need to sacrifice a perfectly level and comfortable ride. Stability issues include roll control, bounce, dive during braking and sponginess. Tuning out these problems usually requires additional air pressure, strut damping, or both.

Checking for leaks

1. Inflate the air spring to 80 PSI.
2. Spray all connections and the inflation valves with a solution of 1/5 liquid dish soap and 4/5 water. Spot leaks easily by looking for bubbles in the soapy water.
3. After the test, deflate the springs to the minimum pressure required to restore the system to normal ride height.
4. Check the air pressure again after 24 hours. A 2 - 4 PSI loss after initial installation is normal. Retest for leaks if the loss is more than 5 lbs.

Fixing Leaks

1. If there is a problem with a swivel fitting:
 - a. Check the air line connection by deflating the spring and removing the line by pulling the collar against the fitting and pulling firmly on the air line. Trim 1" off the end of the air line. Be sure the cut is clean and square (see fig. 15). Reinsert the air line into the push-to-connect fitting.

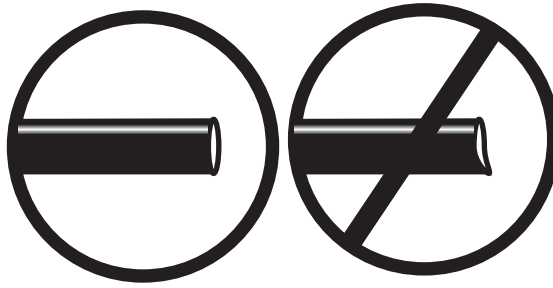

fig. 15

- b. Check the threaded connection by tightening the swivel fitting another $\frac{1}{2}$ turn. If it still leaks, deflate the air spring, remove the fitting, and re-coat the threads with thread sealant. Reinstall by hand tightening as much as possible and then use a wrench for an additional two turns.
2. If the preceding steps have not resolved the problem, call Air Lift customer service at (800) 248-0892.

Warranty and Returns Policy

Air Lift Company warrants the Performance line of products to the original purchaser against manufacturing defects one year from the date of purchase when used on cars and trucks as specified under normal operating conditions. The warranty does not apply to products that have been improperly applied, improperly installed, or which have not been maintained in accordance with installation instructions furnished with all products. The consumer will be responsible for removing (labor charges) the defective product from the vehicle and returning it, transportation costs prepaid, to the dealer from which it was purchased or to Air Lift Company for verification.

Air Lift will repair or replace, at its option, defective products or components. A minimum \$10.00 shipping and handling charge will apply to all warranty claims. Before returning any defective product, you must call Air Lift at (800) 248-0892 in the U.S. and Canada (elsewhere, (517) 322-2144) for a Returned Materials Authorization (RMA) number. Returns to Air Lift can be sent to: Air Lift Company • 2727 Snow Road • Lansing, MI • 48917.

Product failures resulting from abnormal use or misuse are excluded from this warranty. The loss of use of the product, loss of time, inconvenience, commercial loss or consequential damages is not covered. The consumer is responsible for installation/reinstallation (labor charges) of the product. Air Lift Company reserves the right to change the design of any product without assuming any obligation to modify any product previously manufactured.

This warranty gives you specific legal rights and you may also have other rights that may vary from state-to-state. Some states do not allow limitations on how long an implied warranty lasts or allow the exclusion or limitation of incidental or consequential damages. The above limitation or exclusion may not apply to you. There are no warranties, expressed or implied including any implied warranties of merchantability and fitness, which extend beyond this warranty period. There are no warranties that extend beyond the description on the face hereof. Seller disclaims the implied warranty of merchantability. (Dated proof of purchase required.)

Replacement Information

If you need replacement parts, contact the local dealer or call Air Lift customer service at (800) 248-0892. Most parts are immediately available and can be shipped the same day.

Contact Air Lift Company customer service at (800) 248-0892 first if:

- Parts are missing from the kit.
- Need technical assistance on installation or operation.
- Broken or defective parts in the kit.
- Wrong parts in the kit.
- Have a warranty claim or question.

Contact the retailer where the kit was purchased:

- If it is necessary to return or exchange the kit for any reason.
- If there is a problem with shipping if shipped from the retailer.
- If there is a problem with the price.

Contact Information

If you have any questions, comments or need technical assistance contact our customer service department by calling (800) 248-0892, Monday through Friday. For calls from outside the USA or Canada, our local number is (517) 322-2144.

For inquiries by mail, our address is PO Box 80167, Lansing, MI 48908-0167. Our shipping address for returns is 2727 Snow Road, Lansing, MI 48917.

You may also contact us anytime by e-mail at sales@airliftcompany.com or on the web at www.airliftcompany.com.

Need Help?

Contact our customer service department by calling (800) 248-0892. For calls from outside the USA or Canada, our local number is (517) 322-2144.



Thank you for purchasing Air Lift Performance products!

Air Lift Performance • 2727 Snow Road • Lansing, MI 48917 or PO Box 80167 • Lansing, MI 48908-0167
Toll Free (800) 248-0892 • Local (517) 322-2144 • Fax (517) 322-0240 • www.airliftperformance.com

Printed in
the USA