



Installation Instructions

For Part Numbers:

100-257 3.5in. Drv. Sd. Outlet 700-497 Airaid Oiled Media Filter
 100-258 4in. Drv. Sd. Outlet 700-497 Airaid Oiled Media Filter
 100-261 4in. Psgr. Sd. Outlet 700-497 Airaid Oiled Media Filter

Performance Airbox for 1968-1972 GM

A Body Vehicles Chevelle, GTO, Cutlass, and Skylark

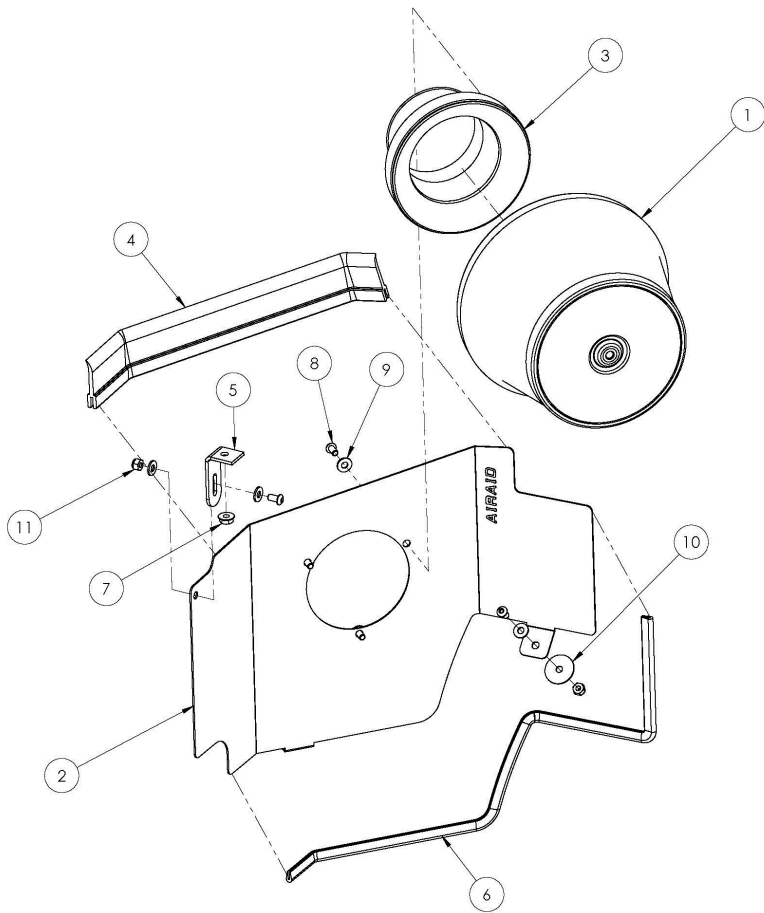

Component Identification

1.	Airaid Premium Filter	1
2.	Cold Air Dam	1
3.	Filter Adapter	1
4.	Weather Strip, 15"	1
5.	L Bracket	1
6.	Edge Trim, 15"	1
7.	5/16" Flange Nut	1
8.	1/4-20 Button Head Bolt	5
9.	1/4" Flat Washer	6
10.	1/4" Fender washer	1
11.	1/4-20 Nylock Nut	2

NOTE: This is not a complete kit. It is a component intended to be used in conjunction with Additional Airaid UBI components.

(Driver side installation pictured)

Passenger Side Application:

If your vehicle has it's battery in the factory location, it along with the battery tray will need to be re located to complete this install.

Full color instructions can be viewed on our web site at Airaid.com.

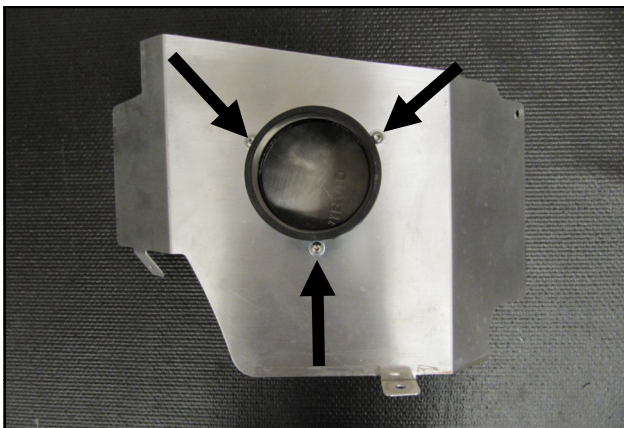

1. Remove the protective film from the sheet metal. Install the Filter Adapter (#3) onto the Air Dam (#2) using three sets of 1/4-20 Button Head Bolts (#8), and 1/4" Flat Washers (#9).

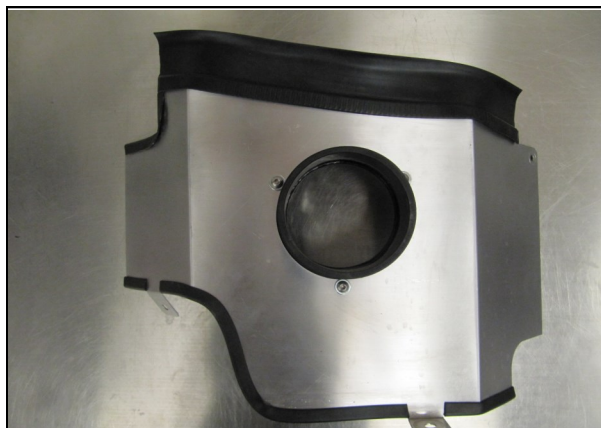

2. Install the Weather Strip (#4) across the top edge of the Air dam, and the Edge Trim (#6) along the bottom edge. Trim pieces to desired length.

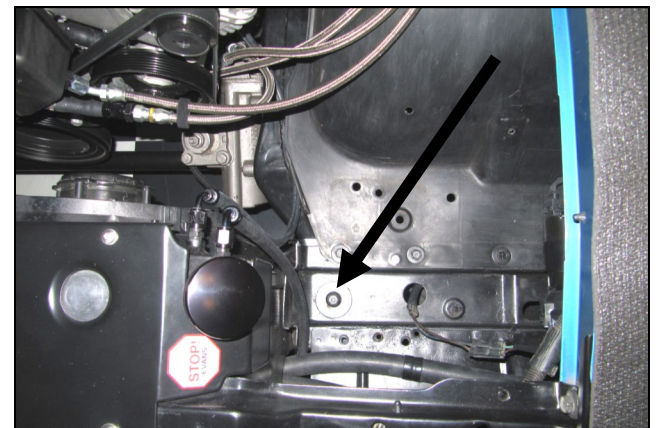

3. Driver Side - Remove the inner fender bolt and set it aside. It will be re used in step #7. Passenger Side - Remove the battery and tray if not already relocated. One of the Tray bolts will be re used in step #7.

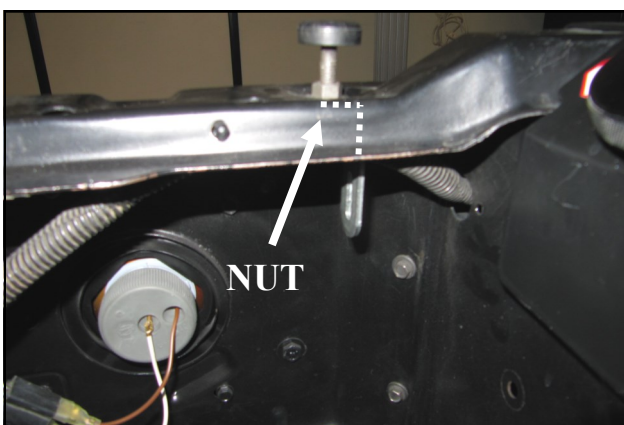

4. Install the L bracket (#5) under the core support. Use the 5/16 Flange nut (#7) to secure it to the lower portion of the hood stop.

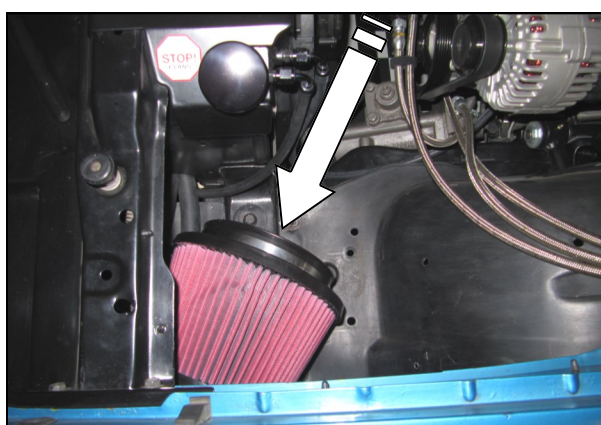

5. Tuck the Airaid premium Filter (#1) into the inner fender.

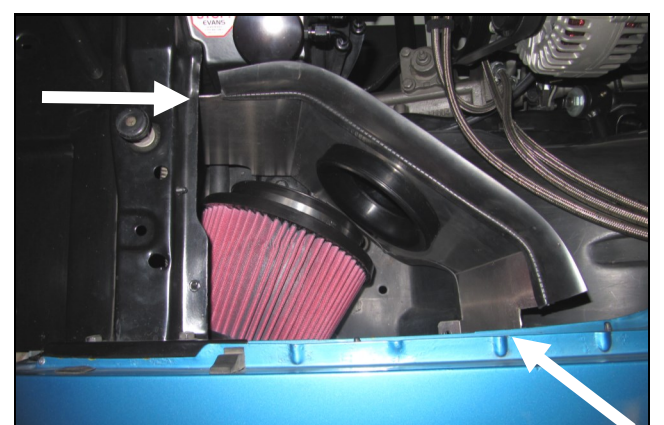

6. Carefully install Air Dam assembly in to the inner fender area. Note-The outermost edges will be underneath the core support and the fender when installed



7. Align the Aid Dam tab with the factory bolt hole from step #3 and secure it by reusing the factory bolt.

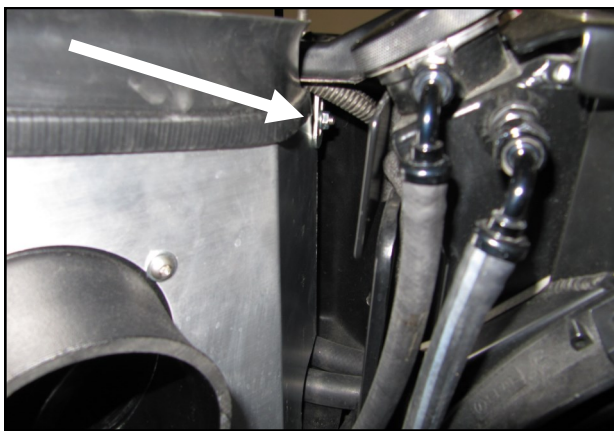

8. Attach the L bracket to the Air Dam using one 1/4-20 Button Head Bolt, Two 1/4" Flat Washers, and one of the 1/4-20 Nylock Nuts (#11).

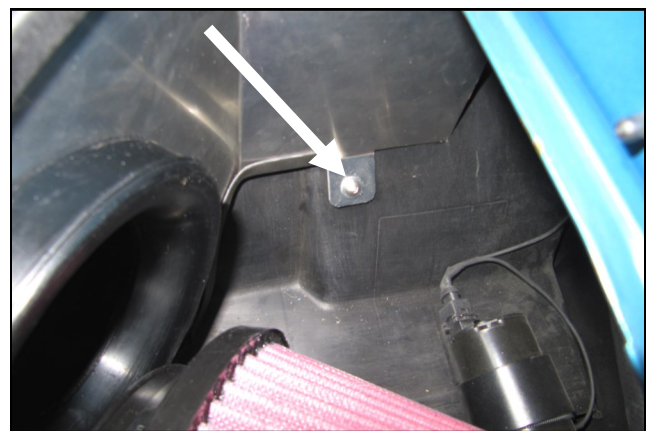

9. The third mounting point will need to be drilled into the inner fender. Secure the Air Dam tab using one 1/4-20 Button Head Bolt, one 1/4" Flat Washer topside, and the Fender Washer (#10) and the last 1/4-20 Nylock nut from below.

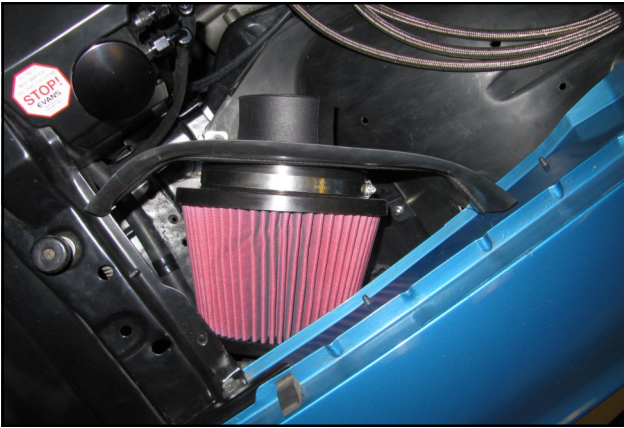

10. Install the Airaid premium onto the Filter adapter and tighten the clamp..



14. Connect the performance airbox assembly to your throttle body or carburetor by using any combination of Airaid's UBI components.

PN 100-300	3.0" UBI Tube Only
PN 100-350	3.5" UBI Tube Only
PN 100-400	4.0" UBI Tube Only

Go to www.airaid.com for a complete list of components for a custom install.

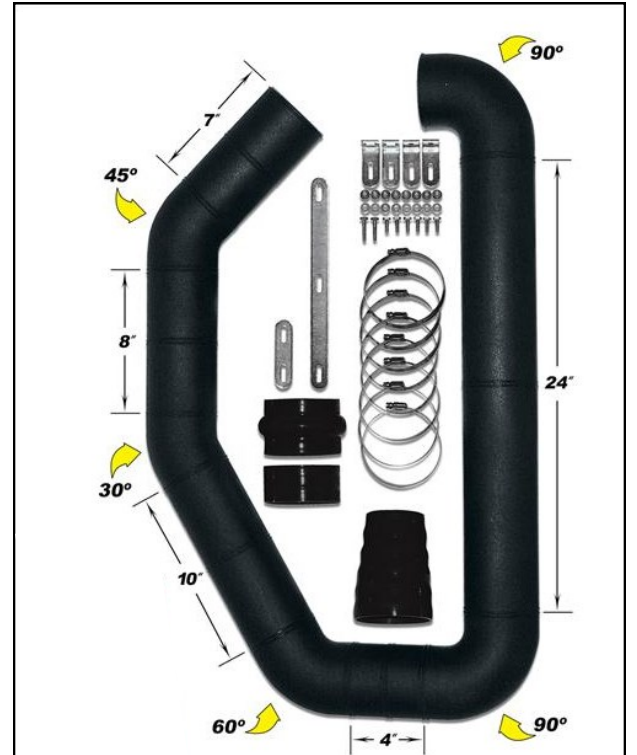

UBI intake kits consist of multiple angles and straights, which you cut as desired. Thousands of intake variations are possible! Available separately, as tubes only, or individual components including ; couplers, clamps, brackets and hardware.



Thank you for purchasing the Airaid UBI System. Contact Airaid @ (800) 498-6951 8:00 AM - 5:00 PM MST weekdays for questions regarding fit or instructions that are not clear to you. Your Airaid UBI System was carefully inspected and packaged. Check that no parts are missing, or were damaged during shipping. If any parts are missing, contact Airaid. The air filter element is protected from direct exposure to water and debris; care should be taken not to drive through deep water. WATER INGESTION IS THE DRIVERS RESPONSIBILITY! The air filter is reusable and should be cleaned periodically.

For your Oiled media filter we suggest using the AIRAID Filter Tune-Up Kit!



P/N 790-551 Aerosol Spray
P/N 790-550 Squeeze Spray



SynthaMax

Do Not Oil

Synthamax Air Filters do not require oil. Service air filter as needed by cleaning with common non-petroleum all-purpose household cleaner and water. Simple Green®, Formula 409® or equivalent works great. Apply cleaner to outside of air filter and allow to soak. Then flush filter clean from the inside out with a garden hose and repeat steps if necessary. Do not apply high pressure water or air to clean filter. Allow filter to air dry and reinstall.