

Airaid

Installation Instructions

For Part Numbers:

254-253 704-495 Airaid Oiled Media Filter - Yellow
 255-253 705-495 SynthaMax Dry Media Filter - Yellow

2009-14 Cadillac CTS-V 6.2L

2011-15 Cadillac CTS-V Coupe 6.2L

NOT LEGAL FOR SALE OR USE ON ANY POLLUTION CONTROLLED MOTOR VEHICLE IN CALIFORNIA OR STATES ADOPTING CALIFORNIA EMISSION PROCEDURES.

See AIRAID.COM for CARB status on each part for a specific vehicle.

Component Identification

1. 704/705-495	Airaid Premium Filter	1
2. KIT253	Airaid Intake Tube	1
3. KIT253MAFPC	MAF Panel	1
4. KIT253RPC	Rear Panel	1
5. KIT253APC	Adapter Panel	1
6. KIT253TOPC	Top Cover	1
7. KIT253CBC	OEM Cover Bracket	1
8. KIT1121MAFADA	Filter Adapter	1
9. KITCOUPLER02	GM Coupler	1
10. KITHUMPHS05EPDM	Silicone Hump Hose	1
11. KITSTRIP28	Weather Strip 9 3/4"	1
12. KIT6C31MXPPZ	6-32 x 5/16" Phillips Screw	8
13. KIT6CNKEPZ	6-32 Kep Nut	8
14. KIT6NWSAPZ	#6 Flat Washer	8
15. KIT15BHC3063	8-32 x 5/8" Button Screw	2
16. KIT15LW3016	#8 Split Lock Washer	2
17. KIT15DHC3050	1/4-20 Button Head Screw	4
18. 08275	1/4" Flat Washer	4
19. KIT1408MPPBZKC	1/4-20 Phillips Screw (Black)	4
20. KIT1420WZZF	1/4-20 Serrated Nut	1
21. KIT31C75HCS5	5/16-18 x 3/4" Hex Bolt	1
22. KIT25NWUSPZ	5/16" Flat Washer	1
23. KITNUT03	5/8" Well Nut	1
24. KITGRMT03	Grommet	1
25. KITFITTING05	#140 PVC Fitting	1
26. KITHS72	#72 Hose Clamp	3
27. KIT253B	Bracket	1
28. KITX1018	Rubber Edge Trim 8"	1
29. KITFITTING20	5/8" Hose Fir Tree Anchor	2
30. KITFITTING21	Edge Clip Cable Tie	2

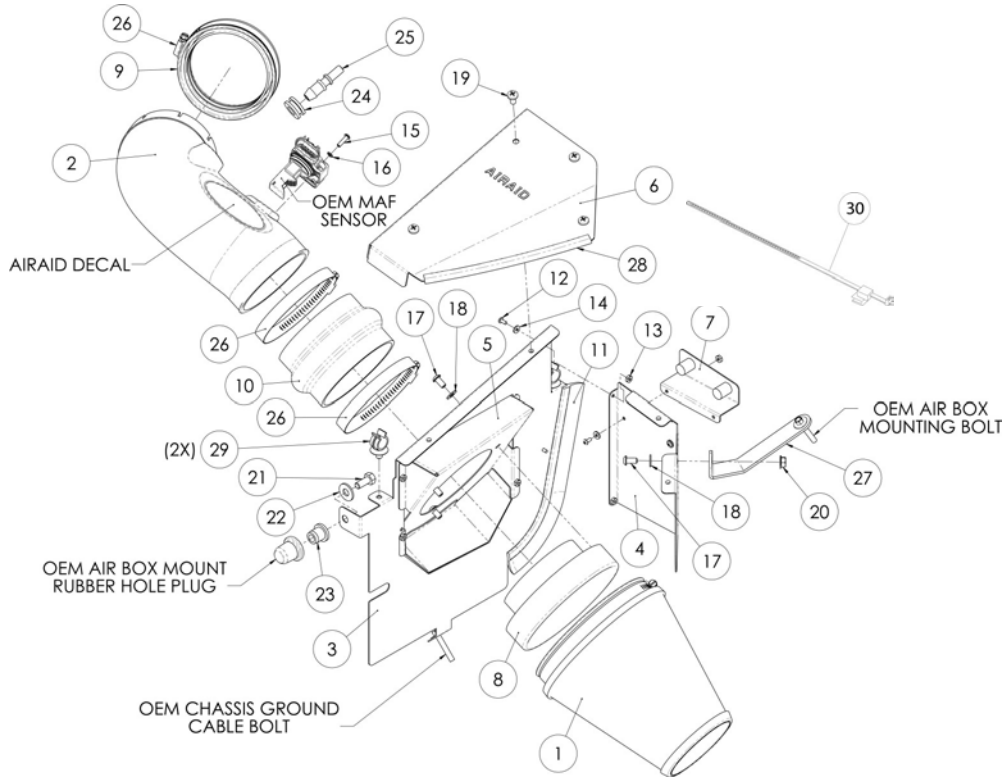

Full color instructions can be viewed on our web site at Airaid.com. If you need any assistance please call 1-800-858-3333 to speak with a representative in our Customer Service Center before returning the product.



1. **Disconnect the negative battery cable.** Remove the engine and shock tower covers by simply pulling up on them and sliding out from the vehicle. These will be reused later in step 14.



2. A) Disconnect the Mass Air Flow (MAF) sensor. B) Disconnect the PCV breather line by depressing the 2 Grey buttons in the fitting and pulling. Loosen the clamps securing the intake tube to the throttle body and airbox and remove the factory intake tube.



3. A) Remove the factory fender bolt securing the airbox assembly. Next pull out the coolant line from atop the airbox lid and gently rotate the airbox assembly towards the front of the vehicle. The airbox assembly is now free and should be removed from vehicle.



4. Use caution not to lose the factory core support grommet while removing the airbox assembly. It will be used in step 11.

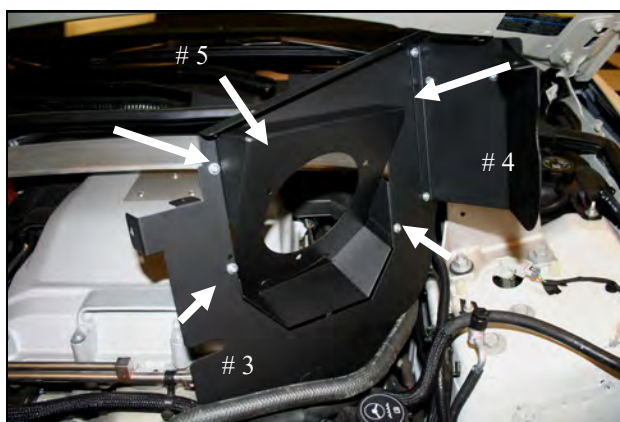

5. Install the Adapter Panel (#5) to the MAF Panel (#3) as shown using four 6-32 screws (#12), 6-32 Kep nuts, and #6 flat washers (#14). Attach the Rear panel (#4) to the MAF panel using two 6-32 screws.

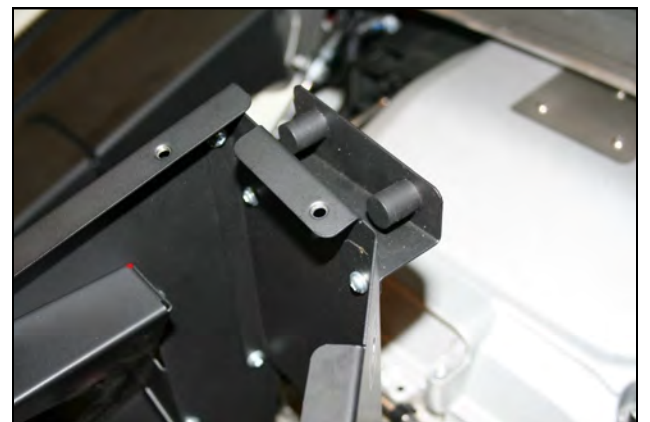

6. Attach the OEM Cover Bracket (#7) to the Rear Panel a shown using the remaining two sets of 6-32 hardware.

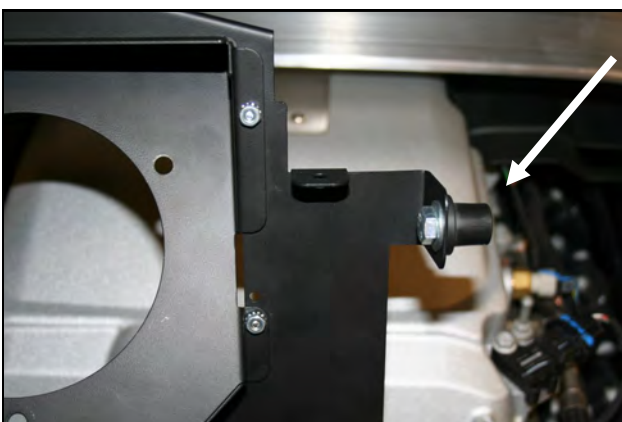

7. Attach the 5/8" Well Nut (#23) to the vertical MAF Panel tab as shown using the 5/16 Hex Bolt (#21) and the 5/16" flat washer (#22).

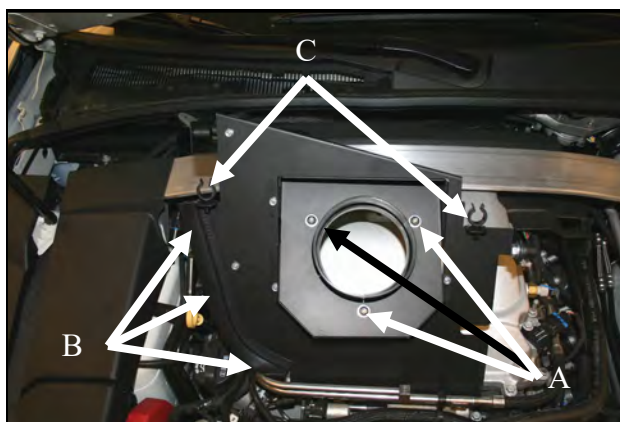

8. A) Install the Filter Adapter onto the MAF panel using three 1/4-20 Button Head screws (#17) and 1/4" Flat washers (#18). B) Attach the Weather Strip (#11) to the curved edge of the MAF Panel. C) Insert the 5/8" hose anchors (#29) into the two horizontal tab holes on the MAF panel

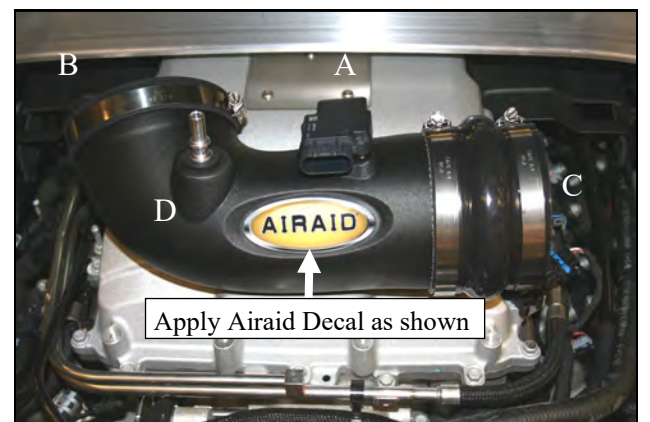

9. A) Transfer the Mass Air Flow sensor from the Factory airbox assembly into the Airaid Intake Tube (#2). Secure to the tube by using the 8-32 screws (#15) and #8 lock washers (#16). B) Install the GM Coupler (#9) on to throttle body side of the intake tube. C) Install the Hump Hose (#10) on the filter side of the intake tube as shown. D) Insert the Grommet (#24) into the hole in the Airaid Intake Tube and then follow by inserting the barbed end of the PCV Fitting (#25) into the Grommet.

Refer to the Exploded View Drawing for additional information on part locations and orientations.



10. Install the Bracket (#27) on to the Rear Panel (#4) as shown using one 1/4-20 Button Head Screw (#19), 1/4" Flat Washer (#18), and 1/4" Serrated Nut(#20). Complete the assembly by attaching the Airaid Premium Filter (#1) to the Filter adapter (#8).

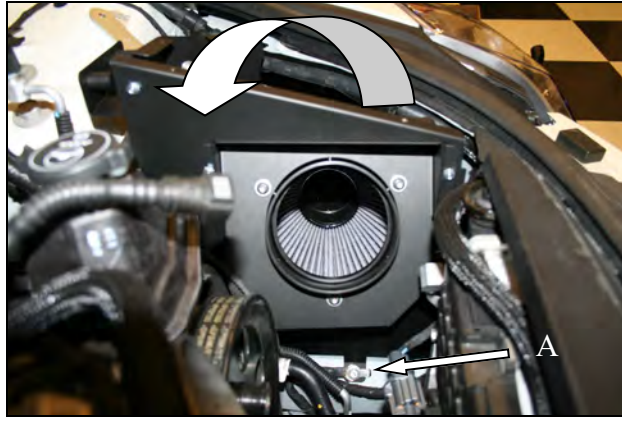

11. **A)** Locate and remove the Factory Ground strap bolt in the chassis. **B)** Lower the Airaid Performance Airbox assembly into the engine cavity. Insert the Well Nut into the Factory core support grommet and rotate the assembly rearward until the bracket rests on the shock tower and the MAF panel's lower tab hole is lined up with the Chassis bolt hole. Secure the assembly by reusing the factory 6mm Chassis Bolt.



12. Install the Airaid Intake Tube (#2) assembly onto the filter Adapter first, and then onto the throttlebody. Adjust for fit, and tighten all 3 hose clamps. Next reconnect the MAF sensor and Breather line. Slide the Edge Clip Cable Ties (#30) about 6" apart along the fender pinch weld and return the coolant line to it's original location. Secure the coolant line using the cable ties and trim off excess.

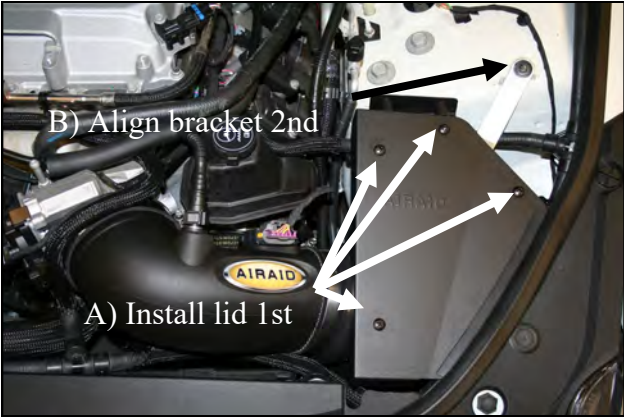

13. **A)** Attach the Edge Trim (#27) on the Cover (#6) as shown and install the cover using the four Black 1/4-20 Phillips Head Screws. **B)** Line up the Bracket with the fender bolt hole and secure using the factory hardware. **Note:** Steps must be performed in order to avoid difficulty with aligning bolt holes.



14. Reinstall the Factory engine and shock tower covers.

15. Double check your work!

Make sure there is no foreign material in the intake path. Make sure all clamps, hoses, bolts, and screws are tight. Double check the hood clearance.

Reconnect the negative battery cable!

Thank you for purchasing the Airaid Intake System. Contact Airaid @ (800) 498-6951 8:00 AM - 5:00 PM MST weekdays for questions regarding fit or instructions that are not clear to you. Your Airaid Intake System was carefully inspected and packaged. Check that no parts are missing, or were damaged during shipping. If any parts are missing, contact Airaid. The air filter element is protected from direct exposure to water and debris; care should be taken not to drive through deep water. WATER INGESTION IS THE DRIVERS RESPONSIBILITY! The air filter is reusable and should be cleaned periodically.

For your Oiled media filter we suggest using the AIRAID Filter Tune-Up Kit!



P/N 790-551 Aerosol Spray
P/N 790-550 Squeeze Spray



SynthaMax[®]

Do Not Oil

Synthamax Air Filters do not require oil. Service air filter as needed by cleaning with common non-petroleum all-purpose household cleaner and water. Simple Green®, Formula 409® or equivalent works great. Apply cleaner to outside of air filter and allow to soak. Then flush filter clean from the inside out with a garden hose and repeat steps if necessary. Do not apply high pressure water or air to clean filter. Allow filter to air dry and reinstall.

NOT LEGAL FOR SALE OR USE ON ANY POLLUTION CONTROLLED MOTOR VEHICLE IN CALIFORNIA OR STATES ADOPTING CALIFORNIA EMISSION PROCEDURES.

See AIRAID.COM for CARB status on each part for a specific vehicle.