



## Installation Instructions

For Part Numbers:

- 350-317 720-127 Airaid Oiled Media Filter
- 351-317 721-127 SynthaMax Dry Media Filter - Red
- 352-317 722-127 SynthaMax Dry Media Filter - Black
- 353-317 723-127 SynthaMax Dry Media Filter - Blue

2011-17 Dodge Challenger  
 2011-17 Dodge Charger  
 2011-17 Chrysler 300  
 3.6L V6

INTAKE SYSTEMS FOR VEHICLES LISTED ARE 50 STATE LEGAL. SEE AIRAID.COM FOR CARB STATUS ON EACH PART FOR A SPECIFIC VEHICLE.

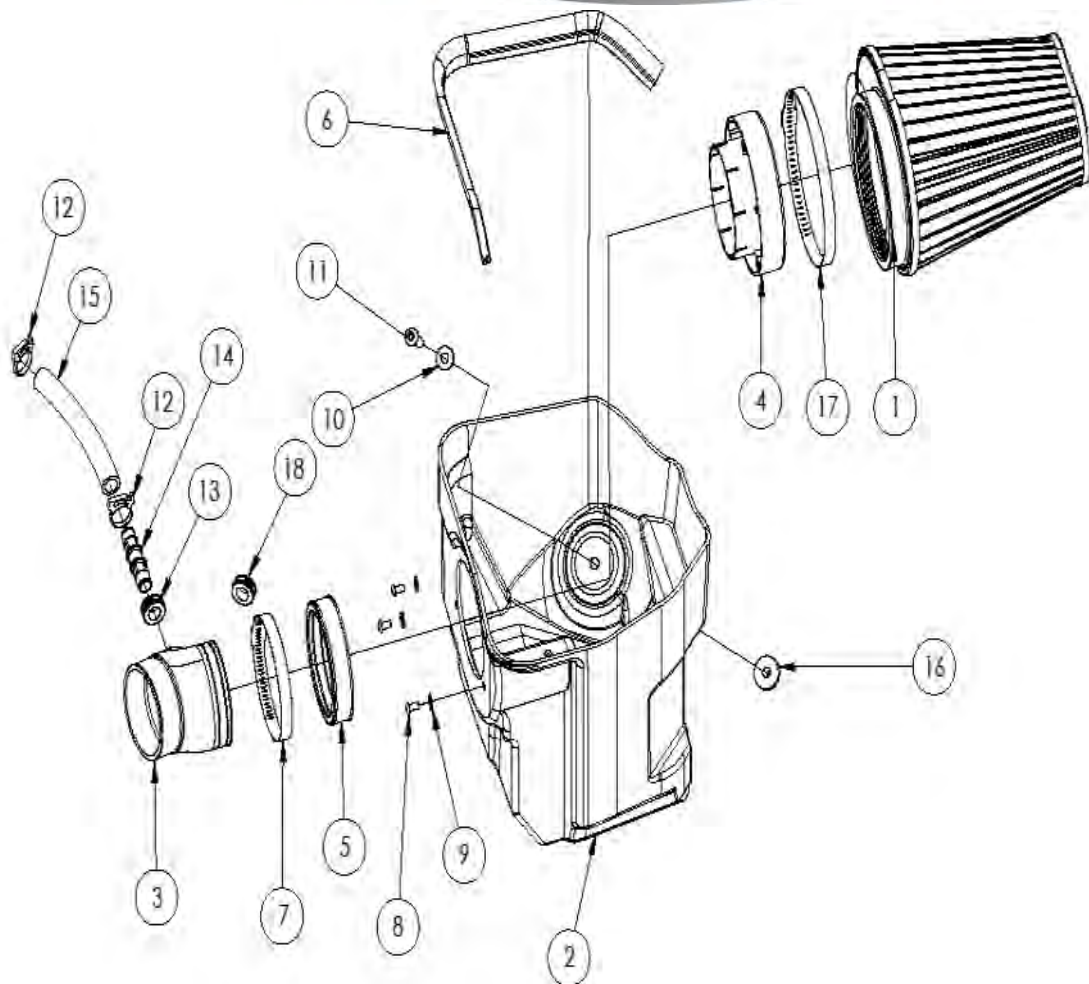

### Component Identification

1. AIR-720,721,722,723-127	Airaid Filter	1
2. AIR-KIT318CAB	Cool Air Box	1
3. AIR-KIT317T	Airaid Intake Tube	1
4. AIR-KITFA01	Filter Adapter	1
5. AIR-KITCOUPLER02	Coupler	1
6. AIR-KITSTRIP14	Weatherstrip	1
7. AIR-KITHS72	Hose Clamp	1
8. AIR-KIT15DHC3050	1/4" Button Head Screw	3
9. AIR-KIT09FWZ019	1/4" Flat Washer	3
10. AIR-KIT31NWUSPZ	5/16" Flat Washer	1
11. AIR-KIT15BHC3150	3/8" Button Head Screw	1
12. AIR-KITSNP19M4	Speed Clamp	2
13. AIR-KITGRMT20	Grommet	1
14. AEM-8-140	Barbed Fitting	1
15. AIR-KITHOSE12	PCV Hose	1
16. 08163	Well Nut	1
17. AIR-KITHS104	Hose Clamp	1
18. 082207	Grommet; Plug 7/8" ID	1

Full color instructions can be viewed on our web site at [Airaid.com](http://Airaid.com). If you need any assistance please call 1-800-858-3333 to speak with a representative in our Customer Service Center before returning the product.



1. Disconnect the negative battery terminal, located in the trunk, by the spare tire.

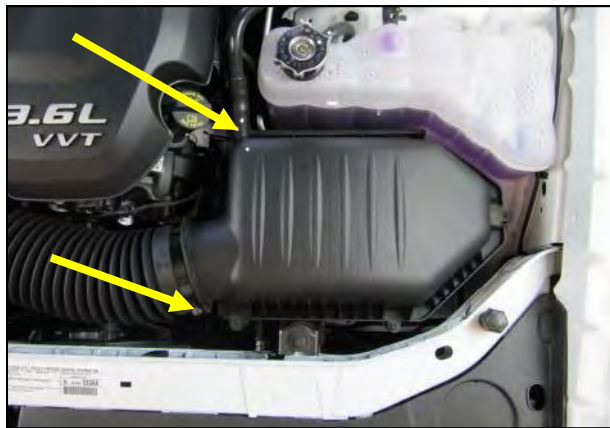

2. Loosen the hose clamp on the air box outlet and disconnect the intake tube. Separate the crankcase breather from the air box lid.



3. Remove the air box screw in the core support and lift the air box out of the vehicle. Set the screw aside, it will be reused in step 11.



4. Install the Filter Adapter onto the Cool Air Box using the three 1/4" Button Head Screws and 1/4" Flat Washers, (#s 8&9). Apply the Airaid Bubble Decal inside the Air-box as shown.



5. Slide the Coupler and Clamp onto the Filter Adapter as shown. Do not tighten the Clamp at this time.



6. Insert the Grommet into the Intake tube. **NOTE: On some models the CCV hose does not connect to the factory air filter housing but connects to the intake tube near the throttle body. On these models install the provided plug into the intake tube in place of the grommet.**



7. Insert the Barbed Fitting into the Grommet and Tube.



8. Install the Intake Tube into the Coupler as shown, with the Barbed Fitting in the Nine O'clock position. Do not tighten the Clamp at this time.

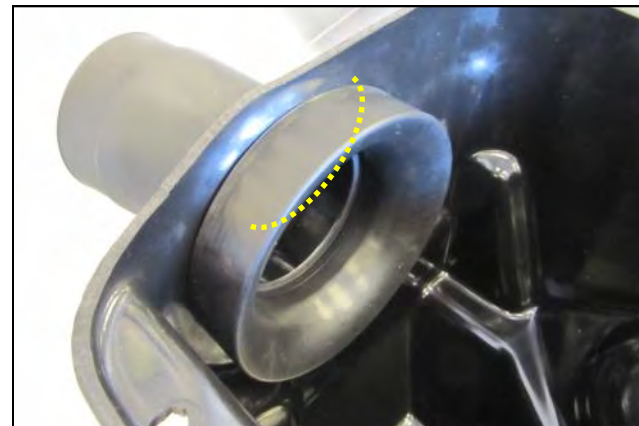

9. When properly installed, the Intake Tube is to be in full contact with the inner edge of the Filter Adapter.



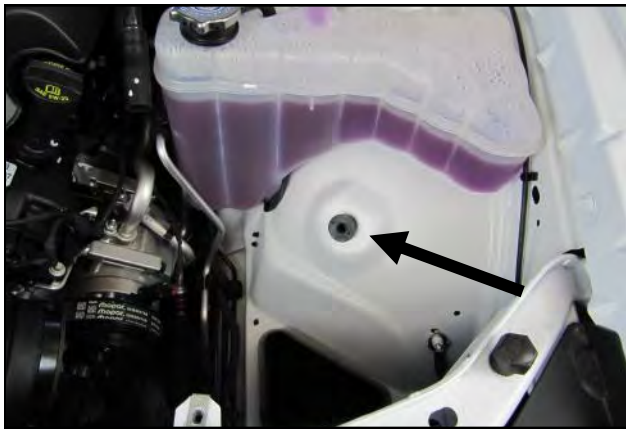

10. Set the Well Nut into the hole in the inner fender.

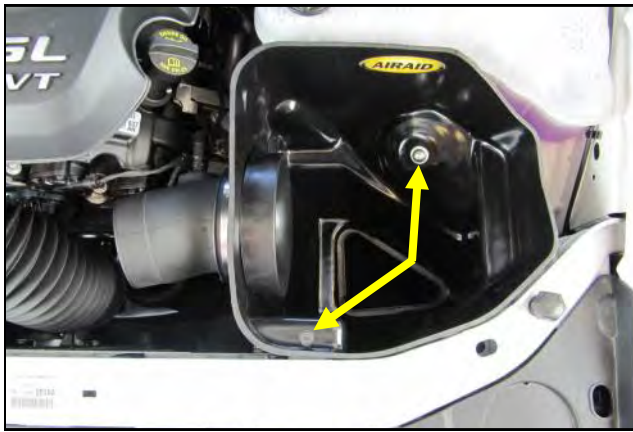

11. Lower the Air Box assembly down into the inner fender. Align the bolt holes and secure the Air Box using the screw removed in step 3 and the 3/8" Button Head Screw with the 5/16" Flat Washer.

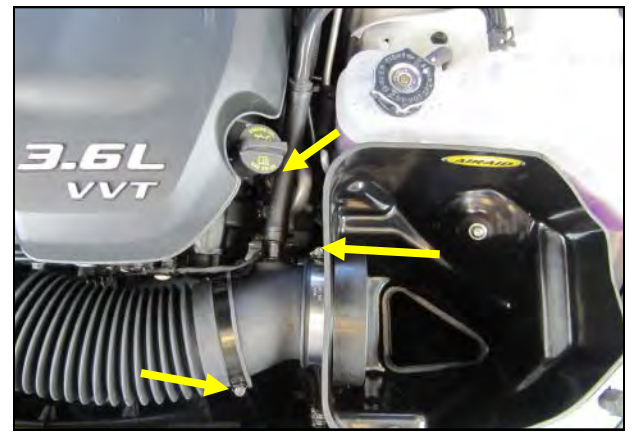

12. When equipped, slide the factory intake tube onto the Airaid Tube, adjust if necessary and tighten the Clamps. Connect the crank case breather line to the Barbed fitting using the supplied PCV Hose.

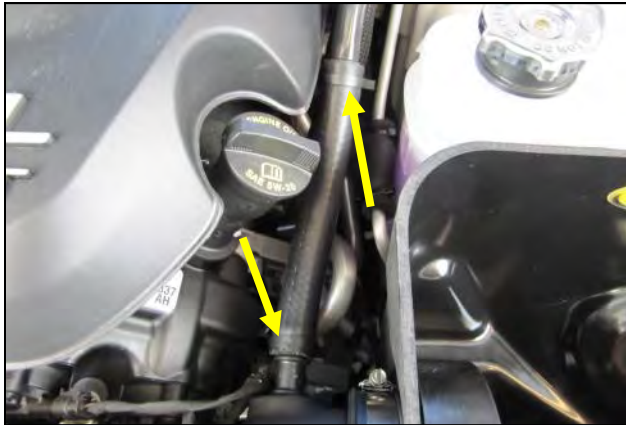

13. When equipped, secure the PCV Hose on both ends using the two Speed Clamps.



14. Install the Airaid Premium Filter onto the Filter Adapter.



15. Install the Weatherstrip onto the top edge of the Air Box with the contour rolling away from the Filter.

### Double check your work!

Make sure there is no foreign material in the intake path. Make sure all clamps, hoses, bolts, and screws are tight. Double check the hood clearance!  
**Reconnect the negative battery cable!**

Thank you for purchasing the Airaid Intake System. Contact Airaid @ (800) 498-6951 8:00 AM - 5:00 PM MST weekdays for questions regarding fit or instructions that are not clear to you. Your Airaid Intake System was carefully inspected and packaged. Check that no parts are missing, or were damaged during shipping. If any parts are missing, contact Airaid. The air filter element is protected from direct exposure to water and debris; care should be taken not to drive through deep water. WATER INGESTION IS THE DRIVERS RESPONSIBILITY! The air filter is reusable and should be cleaned periodically.

### FILTER IDENTIFICATION

720-127 Airaid Oiled Media  
 722-127 Airaid SynthaMax Dry Media - Black

721-127 Airaid SynthaMax Dry Media - Red  
 723-127 Airaid SynthaMax Dry Media - Blue

**For your Oiled media filter  
 we suggest using the AIRAID  
 Filter Tune-Up Kit!**



P/N 790-551 Aerosol Spray  
 P/N 790-550 Squeeze Spray



**INTAKE SYSTEMS FOR VEHICLES LISTED ARE 50  
 STATE LEGAL. SEE AIRAID.COM FOR CARB STATUS  
 ON EACH PART FOR A SPECIFIC VEHICLE.**



### Do Not Oil

Synthamax Air Filters do not require oil. Service air filter as needed by cleaning with common non-petroleum all-purpose household cleaner and water. Simple Green®, Formula 409® or equivalent works great. Apply cleaner to outside of air filter and allow to soak. Then flush filter clean from the inside out with a garden hose and repeat steps if necessary. Do not apply high pressure water or air to clean filter. Allow filter to air dry and reinstall.