

# Airaid

## Installation Instructions

For Part Numbers:

400-293 720-243 Airaid Oiled Media Filter

401-293 721-243 SynthaMax Dry Media Filter - Red

2015-17 Ford F-150

5.0 L V8

INTAKE SYSTEMS FOR VEHICLES LISTED ARE 50 STATE LEGAL. SEE AIRAID.COM FOR CARB STATUS ON EACH PART FOR A SPECIFIC VEHICLE.

### Component Identification

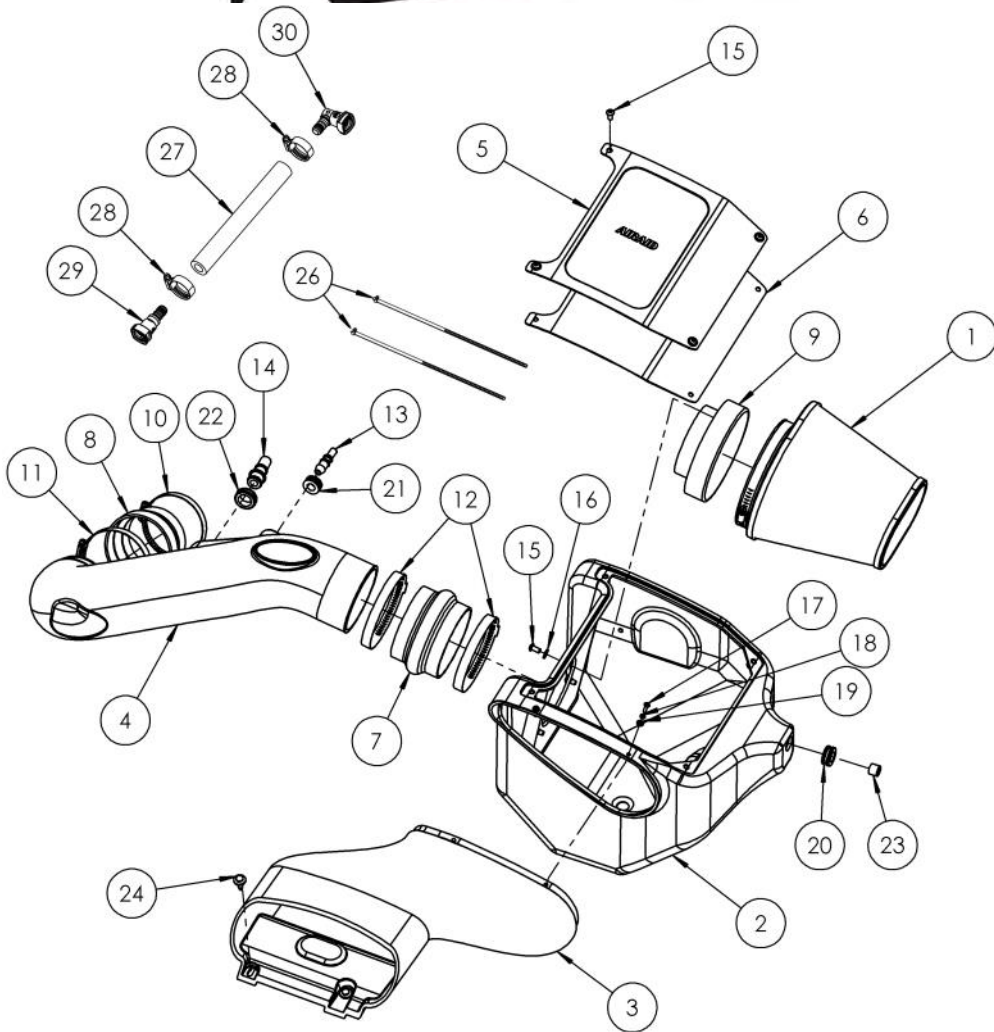

1 AIR-KIT720/721-243	Airaid Premium Filter	1
2 AIR-KIT338CAB	Cold Air Box	1
3 AIR-KIT338INLET	Air Inlet	1
4 AIR-KIT293	Airaid Intake Tube	1
5 AIR-KIT338LID-1	Airaid Airbox Lid	1
6 AIR-KIT338G	Lid Gasket	1
7 AIR-KITHUMPHS05EPDM	Hump Hose	1
8 AIR-KITRDCR10	Reducing Coupler	1
9 AIR-KIT1121MAFADA	Filter Adapter	1
10 08620	#56 Hose Clamp	1
11 AIR-KITHS64	#64 Hose Clamp	1
12 AIR-KITHS72	#72 Hose Clamp	2
13 AIR-KITFITTING05	Aluminum Fitting, Sm	1
14 AIR-KITFITTING15	Aluminum Fitting, Lg	1
15 AIR-KIT15DHC3050	Button Head Cap Screw	7
16 08275	1/4" Flat Washer	3
17 AIR-KIT15BHC3063	8-32 x 5/8" Button Head Screw	2
18 AIR-KIT15LW3016	#8 Split Lock Washer	2
19 AIR-KIT15FW3016	#8 Flat Washer	2
20 AIR-KITGRMT10	5/8" ID Grommet	1
21 AIR-KITGRMT03	1/2" ID Grommet	1
22 AIR-KITGRMT20	13/16" ID Grommet	1
23 AIR-KITSPACER09	Spacer	1
24 AIR-KITRETCLP02	Plastic Rivet	2
25 AIR-KITSTICKER12	Airaid Decal	1
26 1-127	Tie Wrap 8"	2
27 08691	HOSE; 5/8"ID X 9"L	1
28 08411	HOSE CLAMP #10 Mini	2
29 08526	VENT; STRT QUICK DISC. FITTING; ELBOW, 90°	1
30 KITFITTING33		1

Full color instructions can be viewed on our web site at [Airaid.com](http://Airaid.com). If you need any assistance please call 1-800-858-3333 to speak with a representative in our Customer Service Center before returning the product.



1. Disconnect the negative battery terminal.

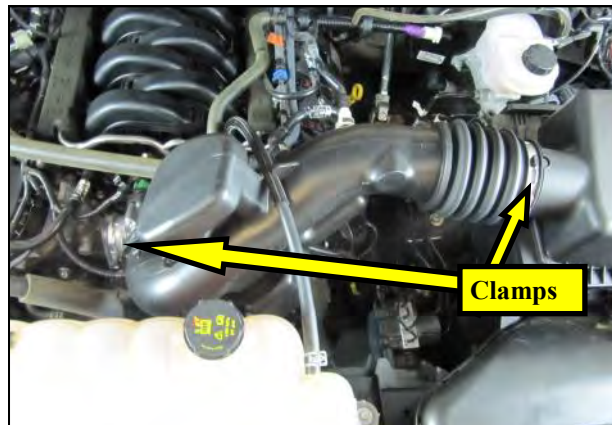

2. Loosen the intake clamps on the throttle body and the air box outlet.

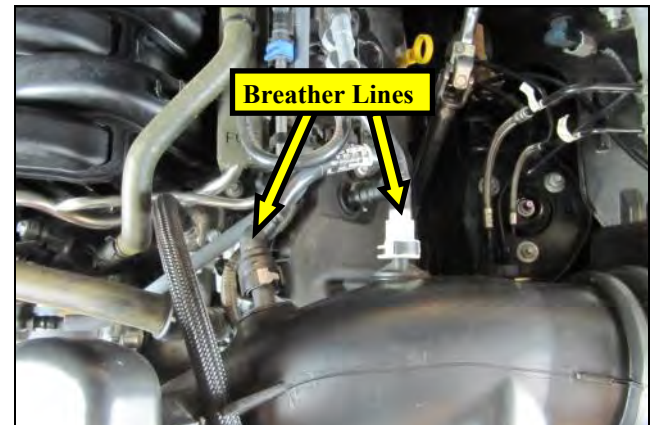

3. Disconnect the two breather lines and remove the intake tube from the vehicle.



4. Using a standard blade screwdriver, gently pry up the center posts of the plastic rivets in the air inlet and remove them.

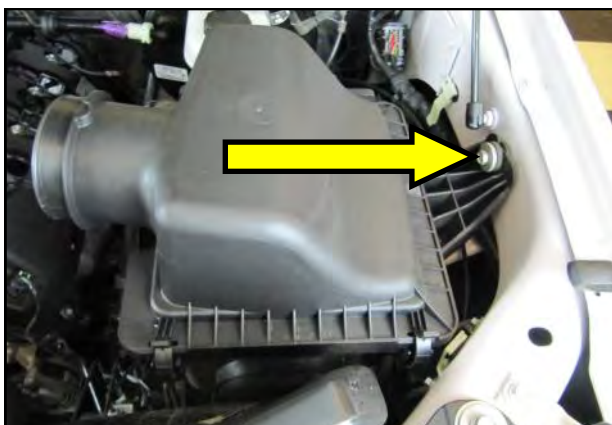

5. Remove the 8mm fender bolt in the air box and remove the entire air box/scoop assembly from the vehicle. **NOTE: On vehicles equipped with a wiring harness attached to the airbox, be sure to unclip the wiring harness from the air box before removal.**

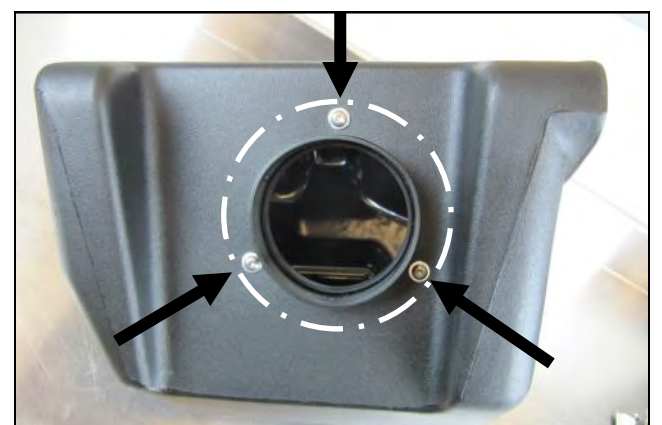

6. Mount the Filter adapter inside of the Airaid Air Box as shown using three sets of the 1/4-20 Button head Screws and Flat washers.

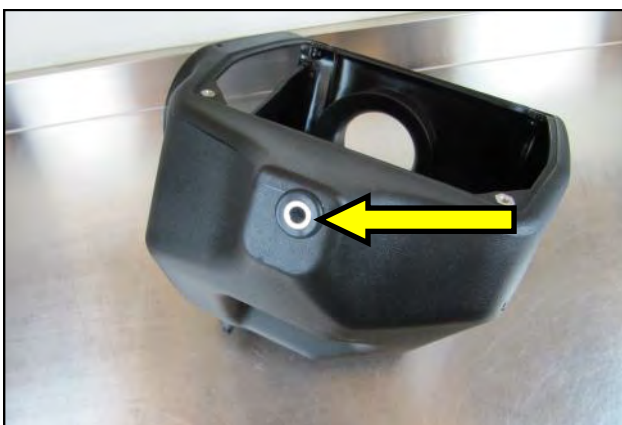

7. Insert the 5/8" Grommet and Spacer into the opposite side of the Airaid Air Box.



8. Snap the new Air Scoop into the Airaid Air Box as shown.



9. Secure the Scoop to the AirBox using the two sets of 8-32 Button Head Screws, Lock Washers and Flat washers.



10. Place the Airaid air Box/Inlet assembly into the inner fender area of the vehicle as shown.

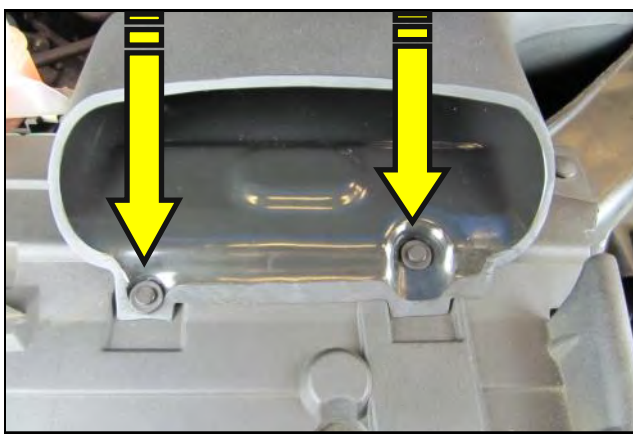

11. Align the mounting holes in the Inlet with the core support holes and secure it using the new, Airaid supplied, Plastic Rivets.

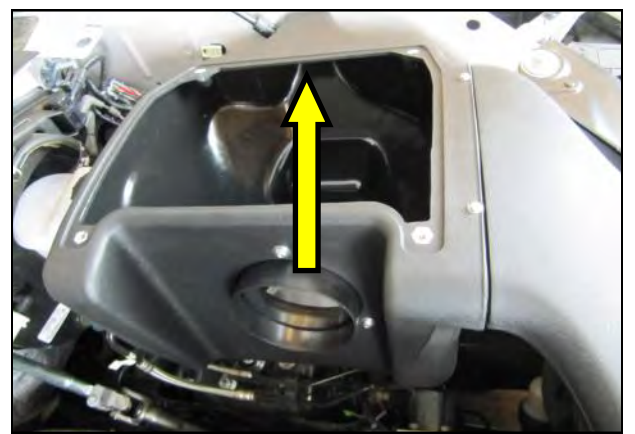

12. Secure the Airaid Air Box to the inner fender using the 8mm bolt removed in step 5.  
**NOTE:** on vehicles that have a wiring harness that was attached to the engine side of the factory air filter housing, find a suitable location (above the tube and below the top of the AIRAID cold air box) and drill two 1/4" id holes. Using the provided mounting tie wraps, secure the wiring harness to the cold air box.

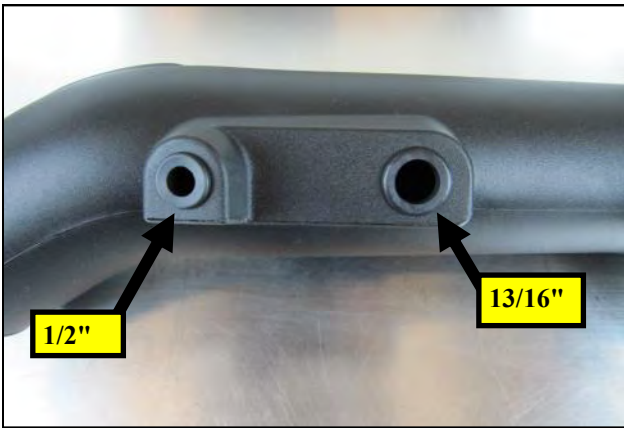

13. Carefully insert the 1/2" and 13/16" Grommets into the Airaid Intake Tube as shown.



14. Gently insert the Aluminum Breather Fittings into the Grommets. **Hint:** Soapy water makes for a good Grommet lube .

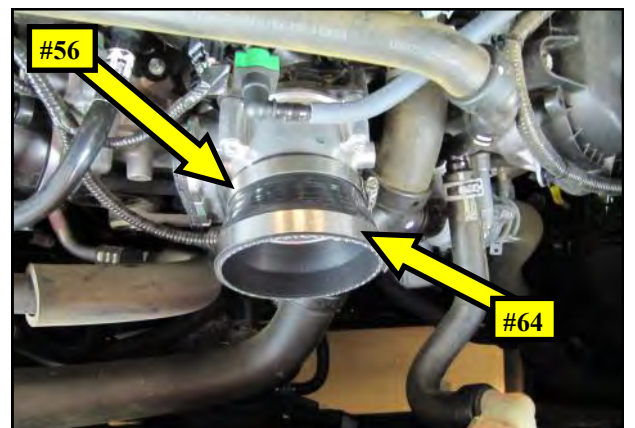

15. Slide the Reducing Coupler and Clamps onto the throttle body as shown. The Small end will use the #56 Clamp and the Large end is to use the #64 Clamp.

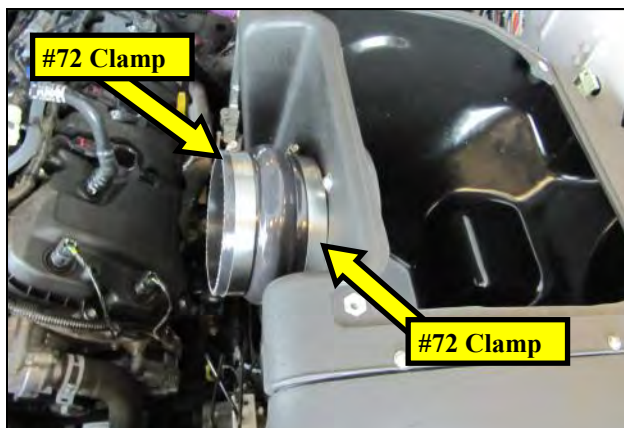

16. Slide the Hump Hose and #72 Clamps onto the Filter adapter, as shown.  
**NOTE:** On vehicles that were equipped with a wiring harness attached to the factory airbox, secure the harness with the provided tie wraps.



17. Insert the Airaid Intake Tube into the throttle body coupler, then into the Air box Hump Hose. Rotate the Tube forwards and backwards until proper alignment is achieved and tighten all four Clamps. Apply the Airaid Decal onto the Tube as shown.

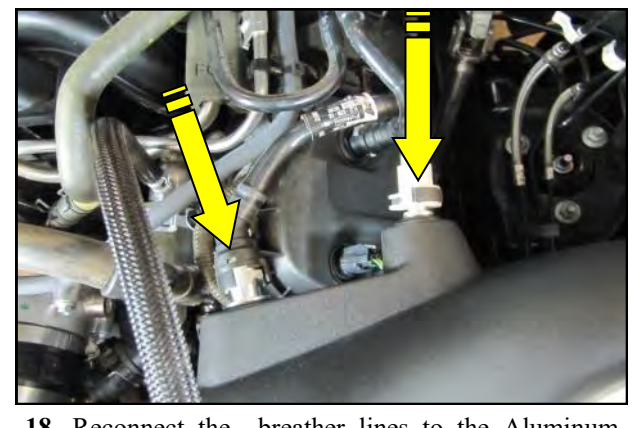

18. Reconnect the breather lines to the Aluminum Fittings in the Intake Tube. When properly installed a distinct "Click" will be heard.  
**NOTE:.** On some later models it may be necessary to assemble the crank case vent hose assembly with the provided parts and install due to the manufacturer changing the position on the valve cover port. Install the assembly with the 90° fitting attached to the valve cover port.



19. Install the Airaid Premium Filter onto the Filter Adapter and tighten the clamp.



20. Remove the protective film from the top of the Air Box Lid. Prepare the underside for the Lid Gasket by cleaning it using a prep-sol or equivalent. Carefully apply the self adhesive Gasket onto the Lid as shown.

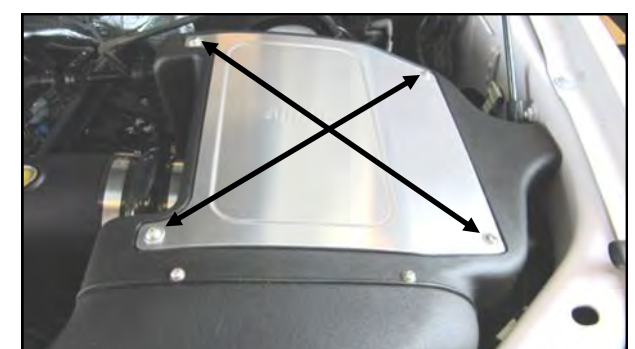

21. Mount the Lid onto the Air Box using the remaining Button Head Screws. Double check your work! Make sure all clamps, hoses, bolts, and screws are tight. Reconnect the negative battery cable!

Thank you for purchasing the Airaid Intake System. Contact Airaid @ (800) 498-6951 8:00 AM - 5:00 PM MST weekdays for questions regarding fit or instructions that are not clear to you. Your Airaid Intake System was carefully inspected and packaged. Check that no parts are missing, or were damaged during shipping. If any parts are missing, contact Airaid. The air filter element is protected from direct exposure to water and debris; care should be taken not to drive through deep water. WATER INGESTION IS THE DRIVERS RESPONSIBILITY! The air filter is reusable and should be cleaned periodically.

## FILTER IDENTIFICATION

720-338 Airaid Oiled Media

721-338 Airaid SynthaMax Dry Media - Red

**Synthamax Air Filters do not require oil.** Service air filter as needed by cleaning with common non-petroleum all-purpose household cleaner and water. Simple Green®, Formula 409® or equivalent works great. Apply cleaner to outside of air filter and allow to soak. Then flush filter clean from the inside out with a garden hose and repeat steps if necessary. Do not apply high pressure water or air to clean filter. Allow filter to air dry and reinstall.

For your Oiled media filter we suggest using AIRAID Filter Tune-Up Kits

P/N 790-551 Aerosol Spray  
P/N 790-550 Squeeze Spray

INTAKE SYSTEMS FOR VEHICLES LISTED ARE 50 STATE LEGAL. SEE AIRAID.COM FOR CARB STATUS ON EACH PART FOR A SPECIFIC VEHICLE.