

Airaid

INSTALLATION INSTRUCTIONS

600-102

2021-23 FORD Bronco

L4-2.3L / V6-2.7L

NOTE: This kit will not increase the manufacturer suggested water fording limit.

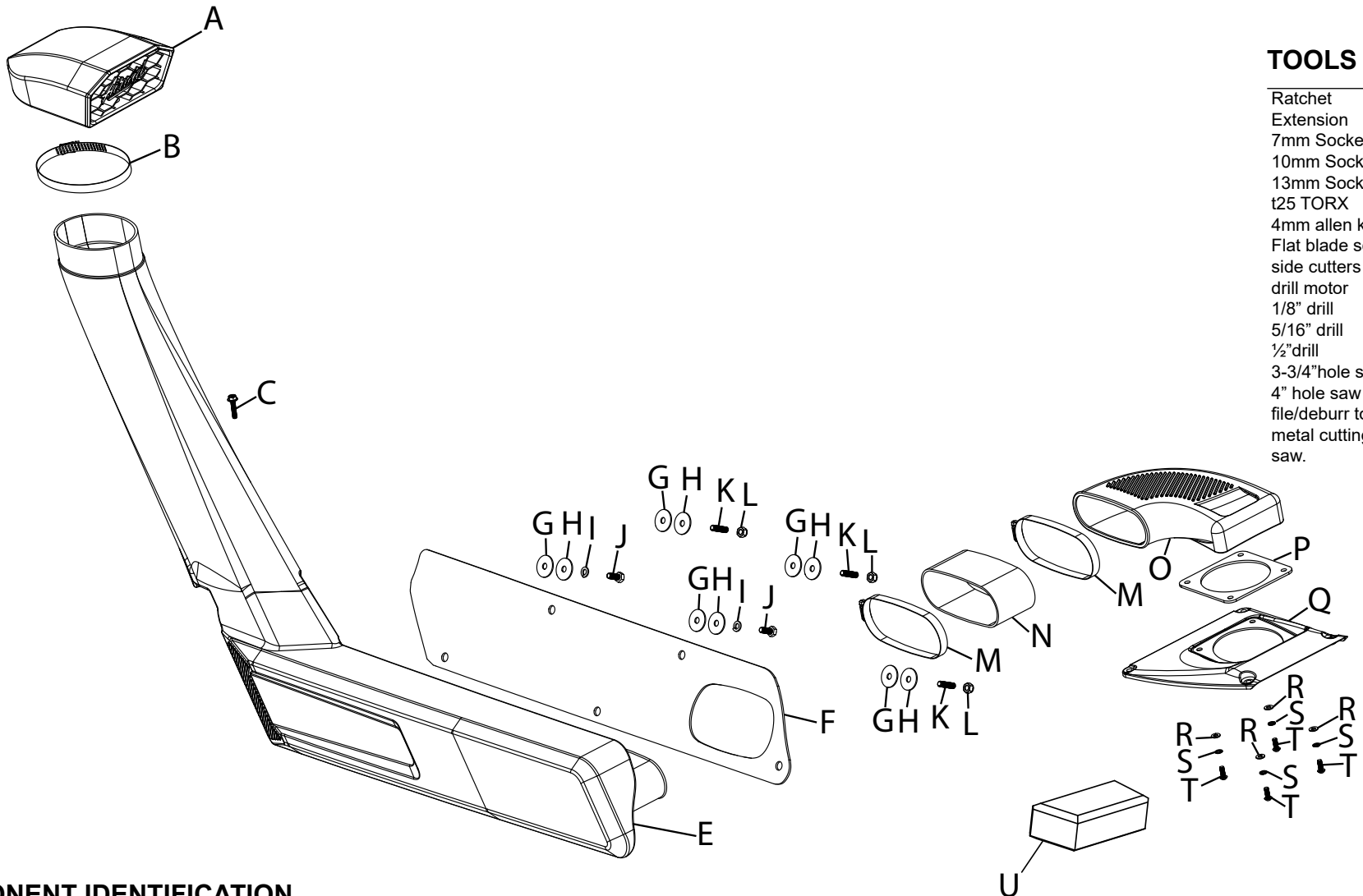

TOOLS NEEDED:

- Ratchet
- Extension
- 7mm Socket
- 10mm Socket
- 13mm Socket
- t25 TORX
- 4mm allen key
- Flat blade screw driver
- side cutters
- drill motor
- 1/8" drill
- 5/16" drill
- 1/2" drill
- 3-3/4" hole saw
- 4" hole saw
- file/deburr tool
- metal cutting wheel or saw.

COMPONENT IDENTIFICATION

Description	Qty.	Part #	Description	Qty.	Part #	Description	Qty.	Part #
A SNORKLE TOP; (PH)	1	087600	H WASHER; 1.25"OD X .30"ID	5	21708	O DUCT; AIRBOX LID, (QD)	1	087536
B HOSE CLAMP; #72, BLK ZINC	1	08671KA	I WASHER; M8 SPLIT LOCK	2	1-3036	P GASKET; ADAPTER TO LID	1	09408
C BOLT; M6-1 X 30, HEX/FLANGE	1	1-1016	J BOLT; 8MM-1.25 X 20MM HEX	2	07787	Q LID; AIRBOX TO SNORKEL	1	088204
D THREADLOCKER; 2ML MED.	1	482	K STUD; 8MM, DOUBLE END	3	070225	R WASHER; 6MM FLAT	4	08269
E SNORKEL; (QE)	1	087537	L NUT; 8MM NYLOCK	3	07502	S WASHER; M6 SPLIT LOCK	4	1-3025
F GASKET; SNORKEL TO FEND	1	09407	M HOSE CLAMP; #80	2	08694	T BOLT; M6 X 1 X 16MM, BTNHD	4	07730
G WASHER; 5/16 X 1.25" FENDER	5	08130	N HOSE; 2.58"ID W X 6.5"ID OVAL	1	084131	U INSERT; FOAM	1	971979

Full color instructions can be viewed on our web site at Airaid.com. If you need any assistance please call 1-800-498-6951 to speak with a representative in our Customer Service Center before returning the product.

TO START:

NOTE: Installation of these kit requires drilling large holes into the fender. If you do not feel confident doing this installation AIRAID recommends contacting a professional installer.

1. Turn off the ignition and disconnect the negative battery cable.

NOTE: Disconnecting the negative battery cable erases pre-programmed electronic memories. Write down all memory settings before disconnecting the negative battery cable. Some radios will require an anti-theft code to be entered after the battery is reconnected. The anti-theft code is typically supplied with your owner's manual. In the event your vehicles anti-theft code cannot be recovered, contact an authorized dealership to obtain your vehicles anti-theft code.



2. Jack up the front passenger side of the vehicle and support with a jack stand. Remove the front tire.



3. On vehicles equipped with extended fender flares, rotate the quarter turn fasteners counterclockwise to release and then remove the flare from the vehicle.

Continued...



4. Remove the fasteners that secure the inner fender and then remove the inner fender from the vehicle.



5. Remove the two bolts that secure the windshield washer bottle filler neck and remove the filler neck from the vehicle.



6. Unhook the wiring harness from the washer bottle.



7. Disconnect the windshield washer hose at the union fitting and then unhook the mount from the inner fender.



8. Remove the nut and push pin that secures the washer fluid tank and then remove the tank. Use caution to avoid damaging the tank or hoses, maneuver the tank back and forth for it to drop down from the fender.

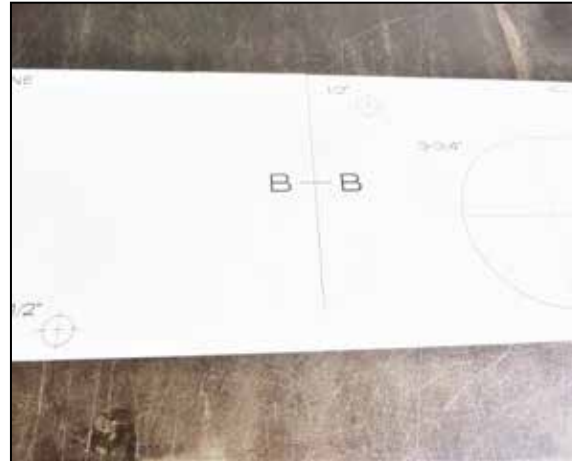
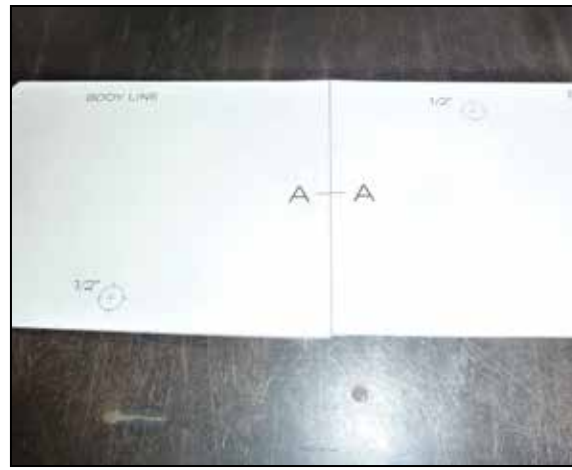

9. Cut the fender drill pattern along the lines and tape them together. Be sure to be accurate when taping the templates together.



10. Apply painters' tape to the fender to protect the surrounding paint while drilling holes.



11. Install the assembled drill pattern onto the inner fender, the template needs to be placed accurately so the holes are placed in the proper location.

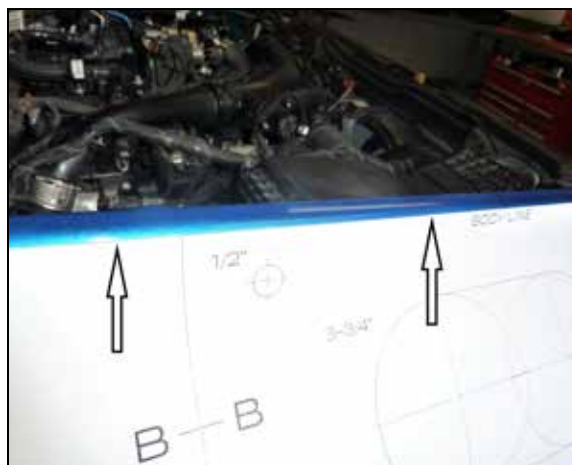

11a. The top edge of the pattern should align with the upper body line.



11b. The rear edge of the pattern should align with the edge of the fender.

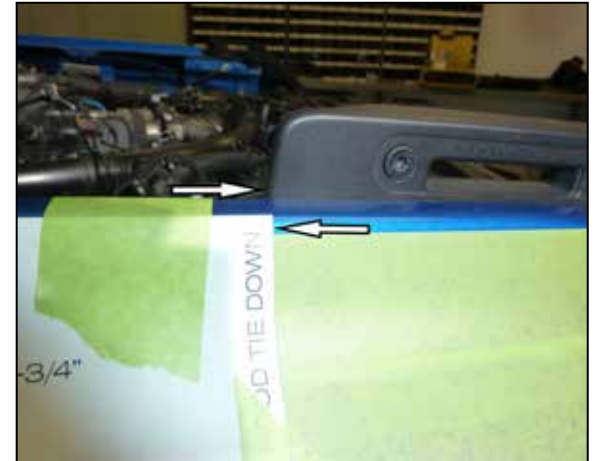

11c. The front edge of the pattern should align with the back edge of the fender sight.

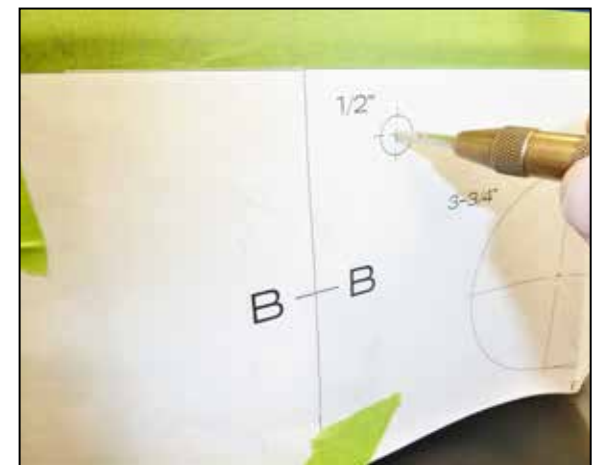

12. Using a punch, mark the seven locations to be drilled.

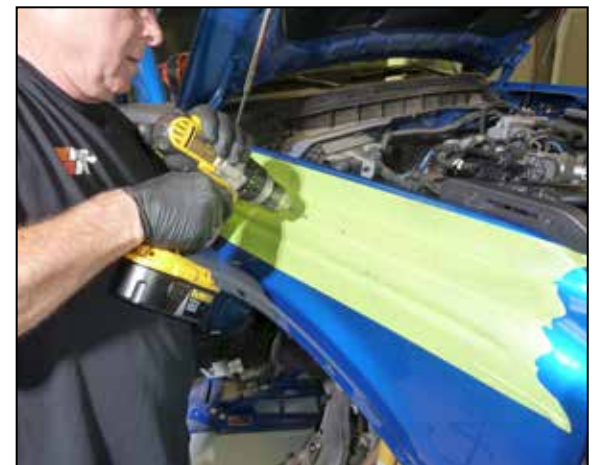

13. Drill a 1/8" pilot hole for all seven holes then drill the five mounting holes with a 1/2" drill.

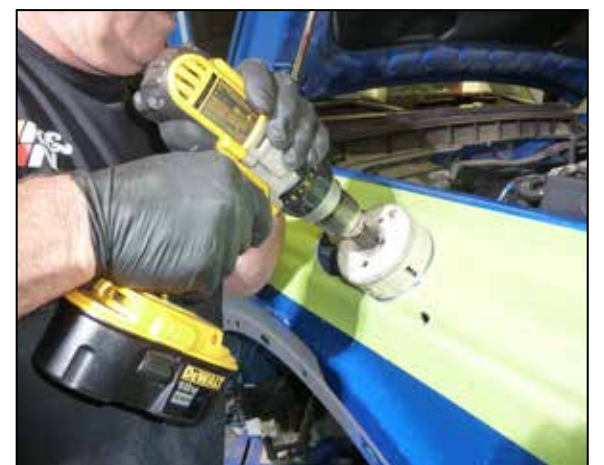

14. Drill the two air duct holes with a 3-3/4" hole saw.

Continued...

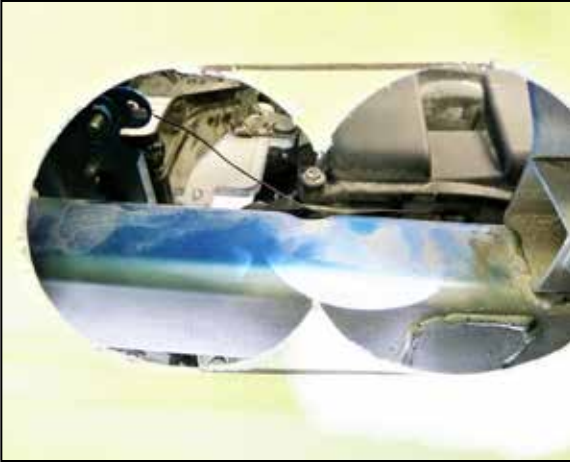

15. Use a marker and connect the two 3-3/4" id holes as shown.



16. Using a cut-off wheel or similar device, cut along the lines from the previous step to turn the two holes into an oval.



17. Deburr the holes with a file or similar device.



18. Apply touch up paint to the raw edge of all the holes.

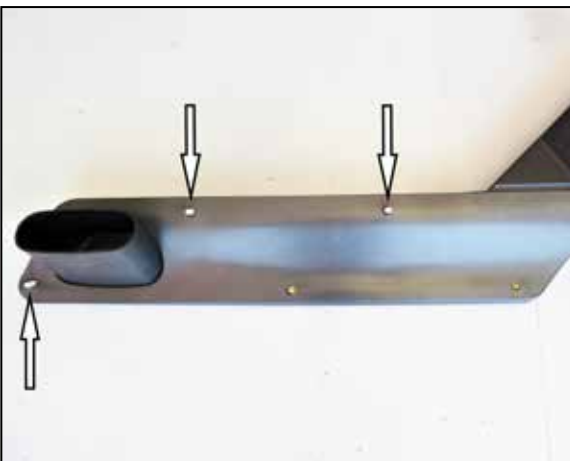

19. Install the three provided 8mm studs into the snorkel in the location shown. Install the foam backing onto the snorkel.



20. Remove the factory bolt show from Cowl/rear view mirror.



21. Set the snorkel onto the fender.



22. Install the three nuts onto the mounting studs along with the fender washers. Do not tighten the nuts.



23. Install the two 8mm bolts with the fender washer. Do not tighten.



24. Install the provided 6mm bolt thru the snorkel into the cowl/mirror mount. Tighten all the mounting hardware.



25. Reinstall the windshield washer bottle using the factory hardware. Secure the wiring harness to the bottle. Reinstall the filler neck using the factory hardware.



26. Reconnect the washer hose connection and secure the hoses with the factory clip.



27. Reinstall the inner fender and secure with the factory bolts. If equipped, reinstall the extended fender flare and secure with the factory quarter turn fasteners, reinstall the wheel and secure with the factory lug nuts torqued to the proper specifications.



28. Install the Snorkel head onto the top of the snorkel and secure with the provided hose clamp. **NOTE: During severe inclement weather AIRAID recommends installing the Snorkel head with the opening pointed towards the rear of the vehicle to prevent water, snow and ice from entering the intake system.**

Continued...



29. Remove the factory air filter housing lid.



30. Cut out the lid drill template and tape onto the air filter housing lid as shown.



31. Drill the four 5/16" holes with a 5/16" drill bit and the 4" hole with a 4" hole saw. Deburr the holes. Some cutting or grinding of the webbing on the inside of the lid will be necessary so the hardware will sit flat.



32. Apply the gasket to the snorkel adapter.



33. Secure the snorkel adapter to the lid using the provided bolts and thread locker.



34. Slide the provided coupler all the way onto the snorkel outlet.



35. Install the lid back onto the air filter housing and secure with the factory hardware. Removing the rear housing mounting bolt will allow easier access the rear/fender side bolt. Once the bolts are tight, resecure the air filter housing with the factory bolt.



36. Slide the coupler hose onto the snorkel adapter and secure with the provided hose clamps.



37. If installing this system onto a vehicle that is equipped with a K&N intake system, Install the snorkel adapter onto the provided K&N air box lid using the provided hardware.



38. Install the lid onto the K&N air filter housing and secure with the hardware. Slide the coupler onto the adapter and secure with the provided hose clamps. **NOTE: it is recommended to drill two 3/8" id holes in the bottom of the K&N air filter housing to provided drainage.**



39. **Double check your work!** Make sure there is no foreign material in the intake path. Make sure all clamps, hoses, bolts, and screws are tight. Double check the hood clearance! **Reconnect the negative battery cable!**

Thank you for purchasing the Airaid Intake System. Contact Airaid @ (800) 498-6951 8:00 AM - 5:00 PM MST weekdays for questions regarding fit or instructions that are not clear to you. Your Airaid Intake System was carefully inspected and packaged. Check that no parts are missing, or were damaged during shipping. If any parts are missing, contact Airaid. The air filter element is protected from direct exposure to water and debris; care should be taken not to drive through deep water. **WATER INGESTION IS THE DRIVERS RESPONSIBILITY!** The air filter is reusable and should be cleaned periodically.

For your Oiled media filter we offer the Airaid Tune Up Kit!



P/N 790-551 Aerosol Spray
P/N 790-550 Squeeze Spray



NOT LEGAL FOR SALE OR USE ON ANY POLLUTION CONTROLLED MOTOR VEHICLE IN CALIFORNIA OR STATES ADOPTING CALIFORNIA EMISSION PROCEDURES.

See Airaid.com for CARB status on each part for a specific vehicle



Synthamax Air Filters **do not** require oil. Service air filter as needed by cleaning with common non-petroleum all-purpose household cleaner and water. Simple Green®, Formula 409® or equivalent works great. Apply cleaner to outside of air filter and allow to soak. Then flush filter clean from the inside out with a garden hose and repeat steps if necessary. Do not apply high pressure water or air to clean filter. Allow filter to air dry and reinstall.

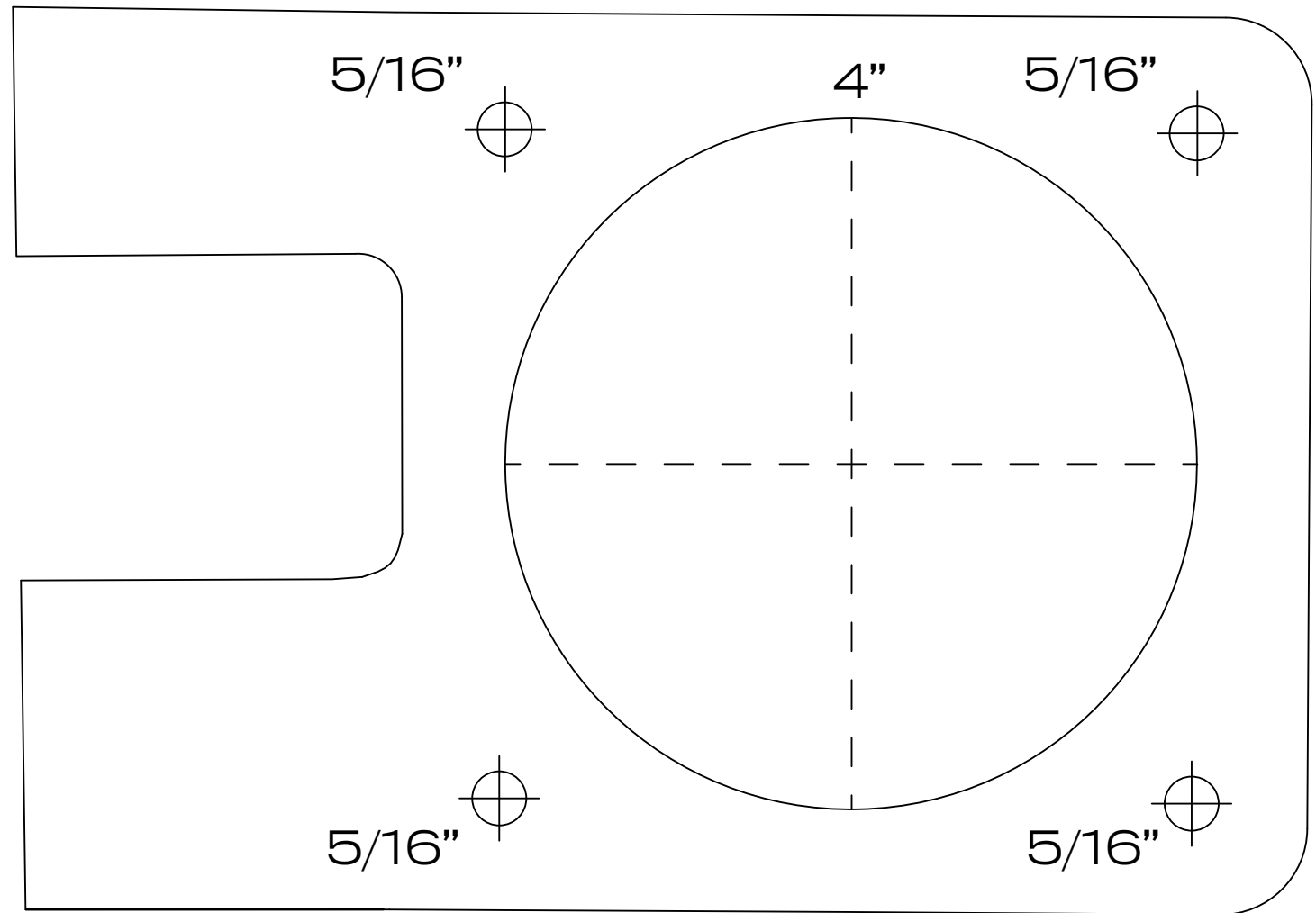

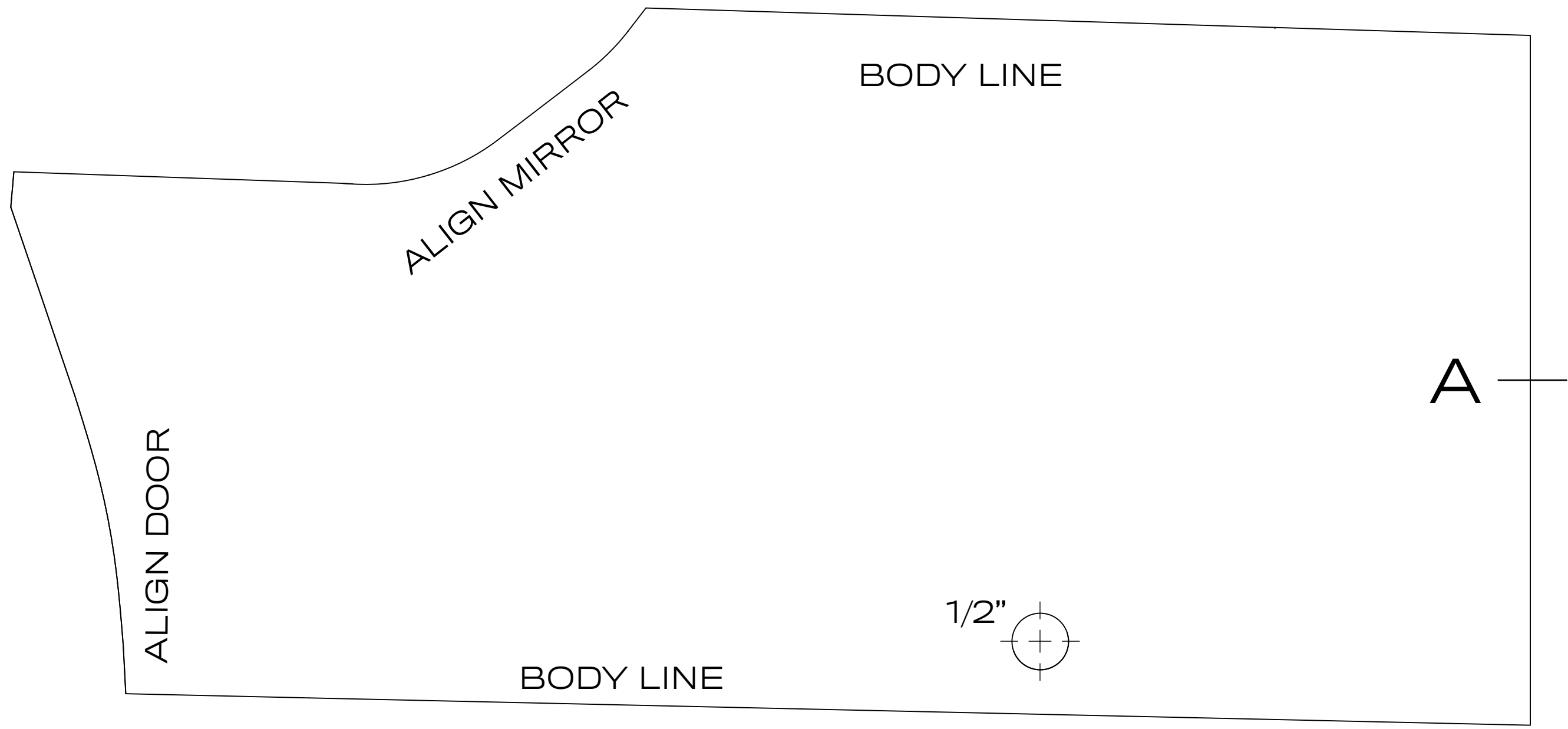

ALIGN DOOR

ALIGN MIRROR

BODY LINE

BODY LINE

A

1/2"

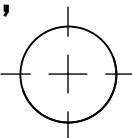

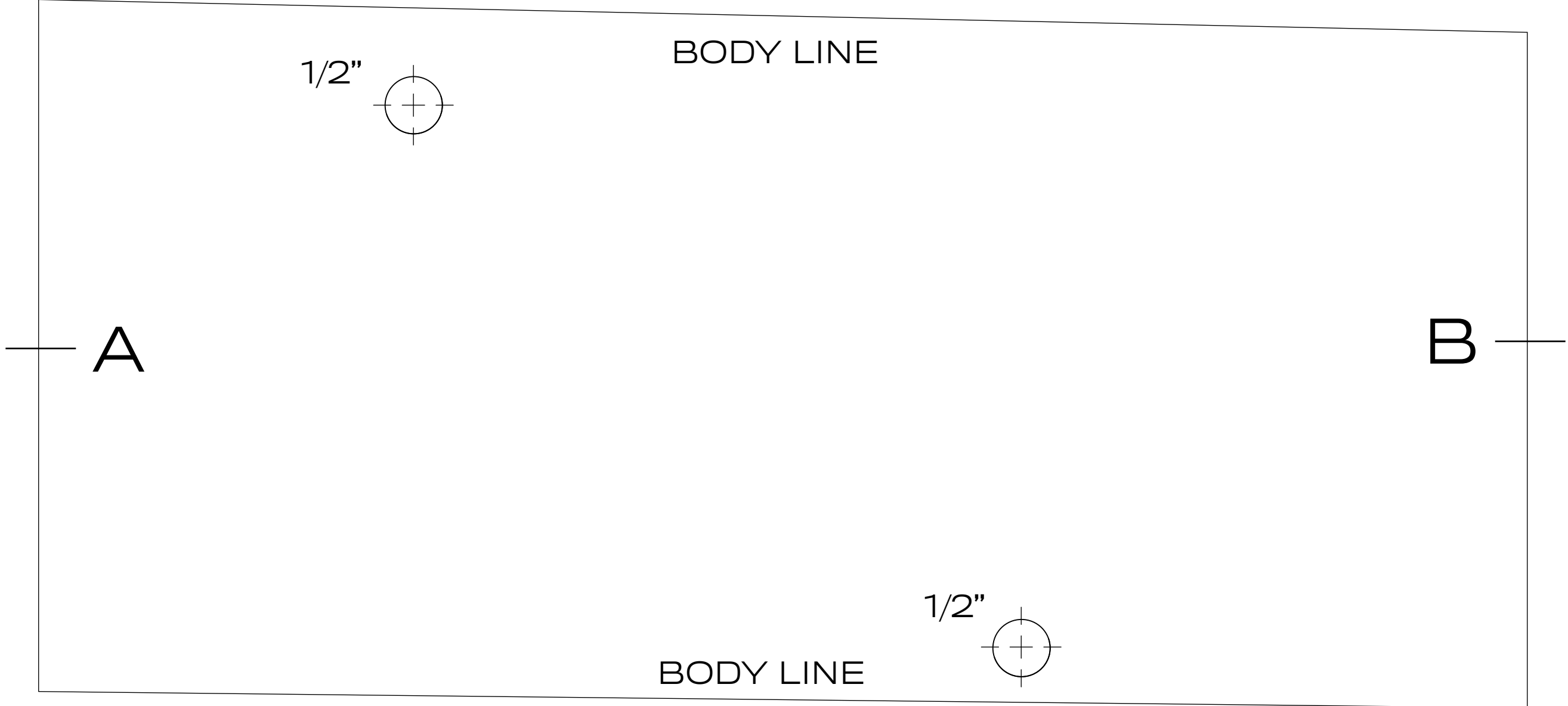

1/2"

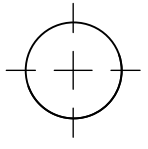

BODY LINE

A

B

1/2"

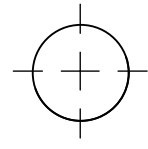

BODY LINE

