



Installation Instructions

For Part Number:
883-274 Intake Kit

2009-13 Kawasaki Teryx
750cc F.I.

Component Identification

1.	Airaid Premium Filter	1
2.	Cold Air Box	1
3.	Air Box Top	1
4.	Filter Adapter	1
5.	Reducing Coupler	1
6.	1/4-20 x 5/8" Hex Head Bolt	5
7.	1/4-20 x 1" Hex Head Bolt	4
8.	M6 x 1.0 x 25 Hex Head Bolt	2
9.	1/4" Flat Washer	11
10.	1/4" Lock Washer	11
11.	#52 Hose Clamp	1
12.	#64 Hose Clamp	1
13.	Adapter Gasket	1
14.	Bubble Sticker	1
15.	Airaid Pre Filter	1

Tools Required For Installation:

7/16" Wrench, 10mm, 7/16" Sockets
Ratchet & Extension
Phillips and Standard Tip Screwdrivers

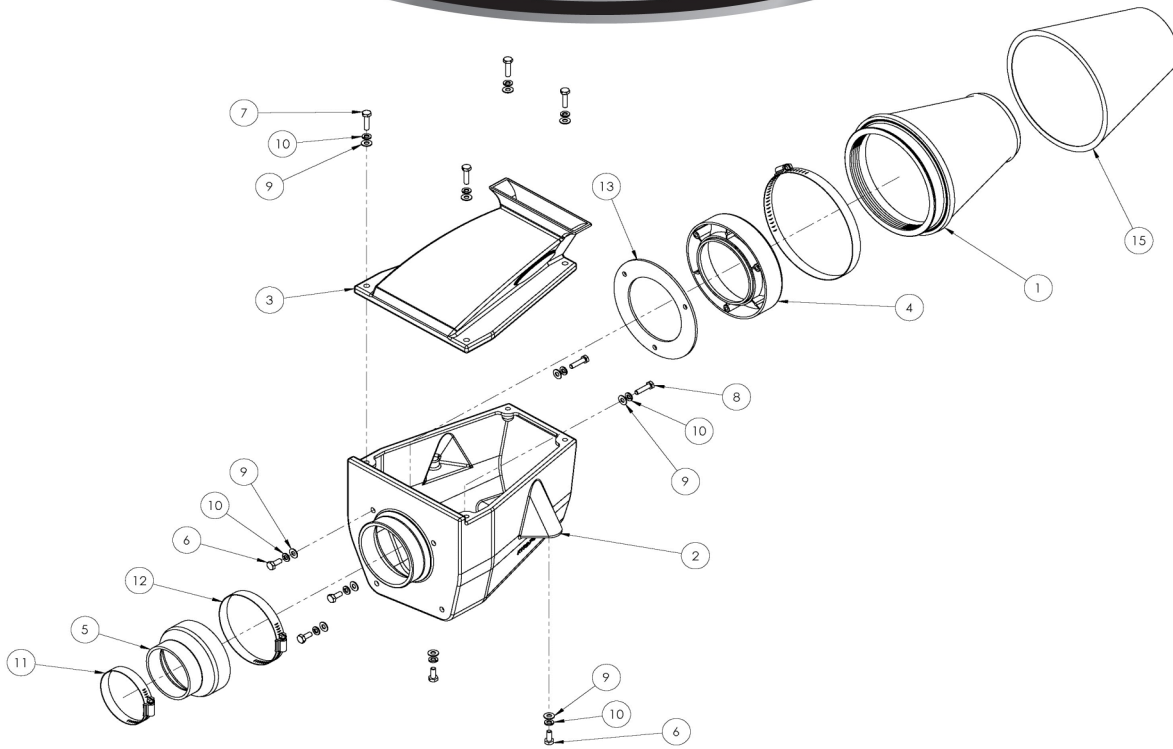

Full color instructions can be viewed on our web site at Airaid.com. Use the **Product Search** function to find your part number, and click **View Details**.

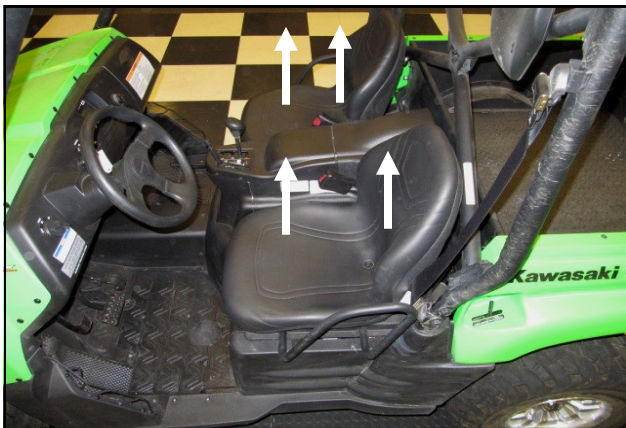

1. Remove both the driver and the passenger side seats. Disconnect the **negative** side battery terminal.



2. The engine covers needing to be removed for this installation are primarily held in place with the use of nylon rivets. Nylon rivets are reusable if care is taken during their removal and installation. Using a small standard blade screwdriver, gently pry up on the center post until the entire rivet can be pulled freely from the panel. Rivet installation is the opposite.

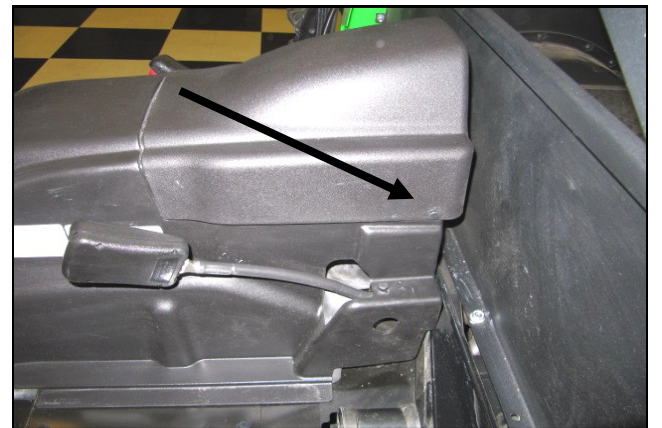

3. Locate and remove the two nylon rivets on either side of the small cover. Remove the cover and set it aside. It will be reused.

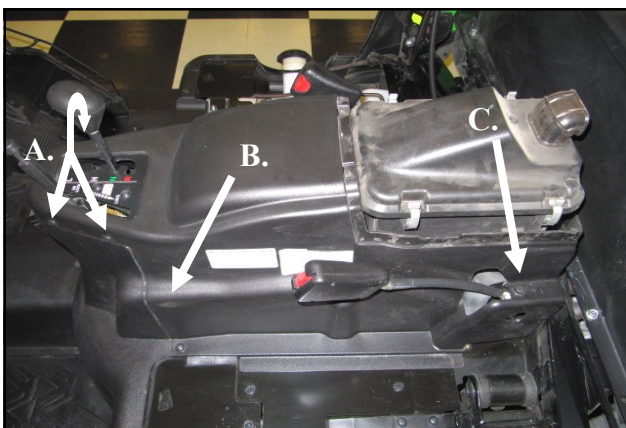

4. Remove the engine cover.
A.) Remove the three small nylon rivets, two on the drivers side, one on the passenger side.
B.) Remove the two Phillips head screws, one on each side.
C.) Remove the two large nylon rivets, one on each side. Pull the cover up and forward clearing the levers and seat belt buckles.

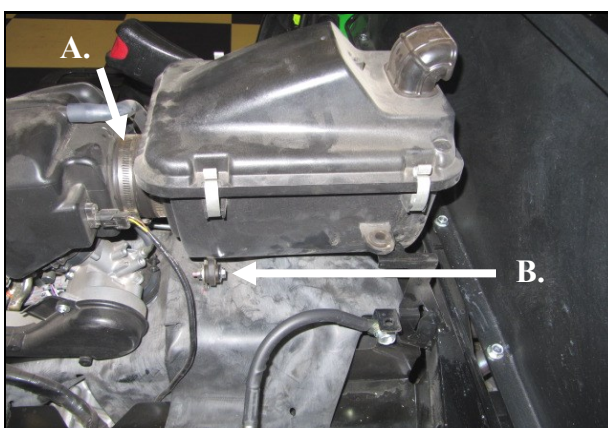

5. Remove the factory airbox assembly.
A.) Loosen the hose clamp on the airbox coupler.
B.) Using a 10mm socket, remove the two factory airbox mounting bolts on either side. Lift the factory airbox up and out of the vehicle.



6. Prepare the Filter Adapter (#4) for installation by attaching the gasket (#13) and lining up the bolt holes.



7. Install the Filter Adapter on the Cold Air Box, or CAB (#2) as shown using three 1/4-20 x 5/8" Bolts (#6), 1/4" lock washers (#10), and 1/4" Flat washers (#9). Do not over tighten.

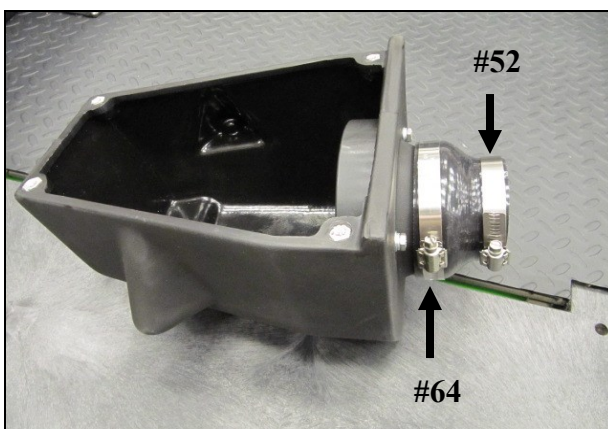

8. Install the Silicone Reducer (#5) and Hose clamps onto the CAB. Place the #64 clamp (#12) on the larger side of the reducer, and the #52 clamp (#11) on to the smaller side.

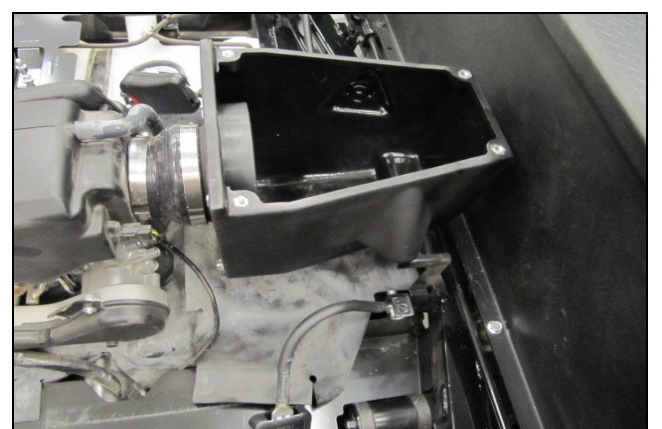

9. Install the CAB assembly onto the factory plenum and tighten the Hose Clamps.

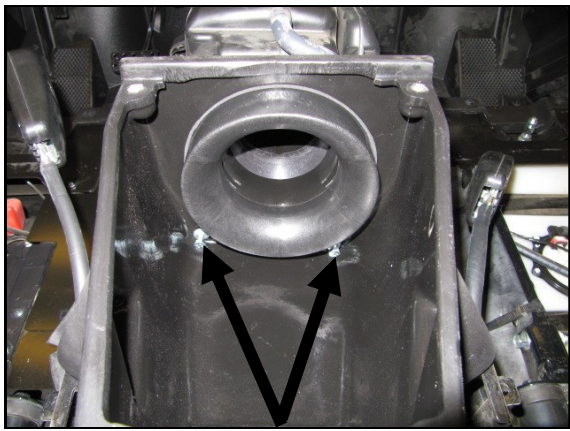

10. Secure the forward half of the CAB assembly to the factory bracket from step number Five, using two M6x1.0x25mm bolts (#8), 1/4" lock washers, and 1/4" Flat washers.



11. Secure the rear half of the CAB assembly to the Horizontal brackets using two 1/4-20 x 5/8" bolts (#6), 1/4" lock washers, and 1/4" Flat washers.

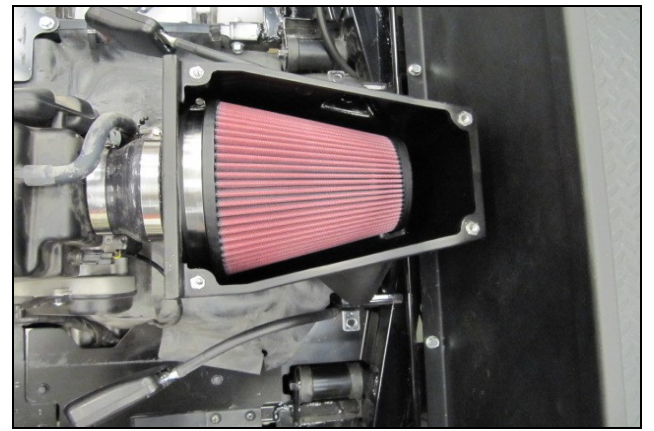

12. Install the Airaid Premium Filter (#1) onto the filter adapter and tighten the hose clamp.



13. Slip the Pre-Filter (#15) over the Airaid Premium Filter.



14. Complete the assembly by installing the Air Box Top (#2) onto the Cold Air Box using four 1/4-20 x 1" bolts (#7), 1/4" lock washers (#10), and 1/4" Flat washers (#9).



15. Reinstall the factory covers in the reverse order of removal. Reconnect the battery terminal and reinstall the seats. Notice that the Air inlet is now located outside of the engine cover.

Thank you for purchasing the Airaid Intake System. Contact Airaid @ (800) 498-6951 8:00 AM - 5:00 PM MST weekdays for questions regarding fit or instructions that are not clear to you. Your Airaid Intake System was carefully inspected and packaged. Check that no parts are missing, or were damaged during shipping. If any parts are missing, contact Airaid. The air filter element is protected from direct exposure to water and debris; care should be taken not to drive through deep water. WATER INGESTION IS THE DRIVERS RESPONSIBILITY! The air filter is reusable and should be cleaned periodically.

For your Oiled media filter we suggest using the AIRAID Filter Tune-Up Kit!



P/N 790-551 Aerosol Spray
P/N 790-550 Squeeze Spray

