



Ventvisor® Deflector

**For proper installation and best possible fit, please read all instructions BEFORE you begin.
For technical assistance or to obtain missing parts, please call Customer Relations at 1-800-241-7219.**

Important Safety Information



- CAUTION - Before driving, ensure that the vent visor is properly secured to vehicle.
- Do not use automatic "brush-style" car washes.
- Do not use cleaning solvents of any kind.
- Periodically check all components for tightness.

Contents - 2 Piece Set **NOTE:** Actual product may vary from illustration.

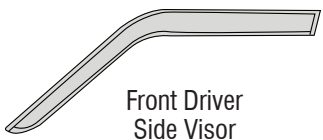

Front Driver Side Visor

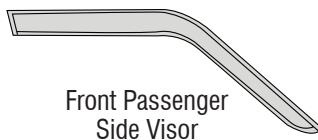

Front Passenger Side Visor



Alcohol Pad x2

Contents - 4 Piece Set

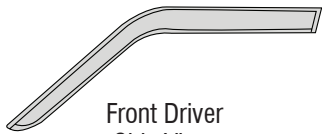

Front Driver Side Visor

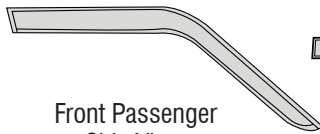

Front Passenger Side Visor



Rear Driver Side Visor



Rear Passenger Side Visor



Alcohol Pad x4

Tools Required



Car Wash Supplies



Clean Towel

Preparation Before Painting / Installation

- A trial fit is recommended to ensure proper positioning and fit.
- Check fit of parts before painting as we will not accept the return of modified or painted parts.
- Wash and dry your vehicle to remove any debris and/or dirt from the installation area.

Installation Steps **NOTE:** Actual application may vary slightly from illustrations.



Lower drivers side window and clean window frame and chrome or black trim with an alcohol pad.

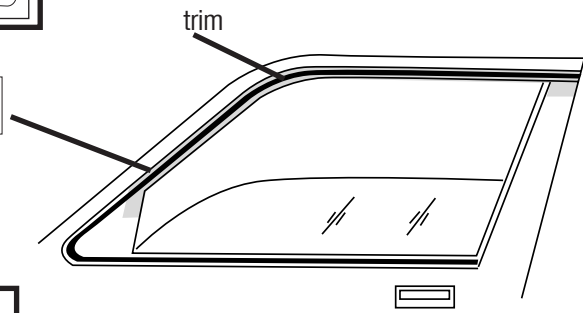

1

NOTE: Visors mount on the OUTSIDE door trim.

Peel back 2" (5 cm) of tape liner from each end of lateral flange.

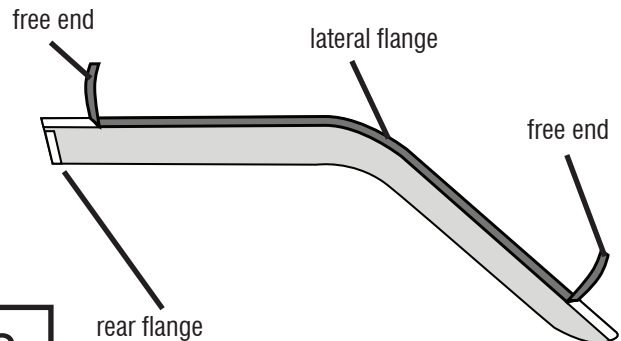

2

Installation Steps

NOTE: Actual application may vary slightly from illustrations.

Align the visor with the previously cleaned surface. The flanges of the visor attach to the surface of the window's chrome or black trim.

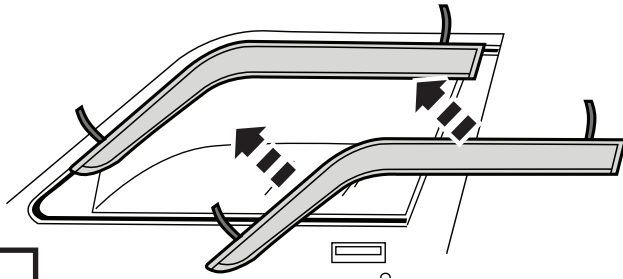

3

Verify proper positioning. With the visor in its final position, remove remaining tape liner by pulling on free ends.

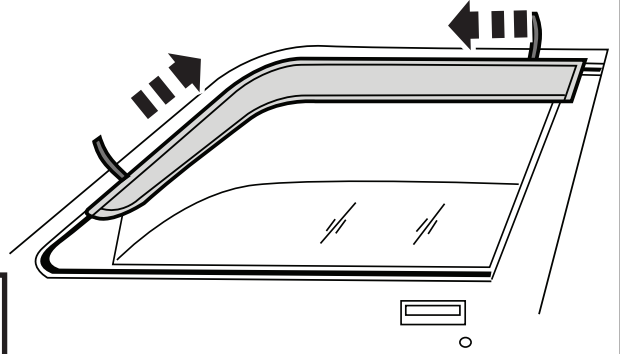

4

Apply pressure along all flanges to ensure adhesion of tape to the trim surfaces.

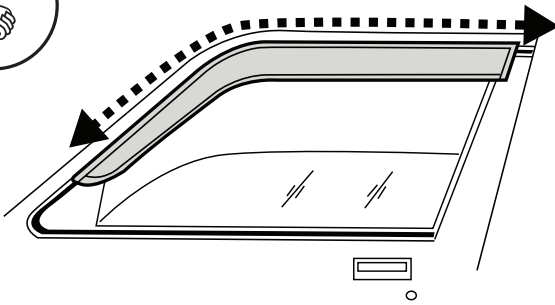

5

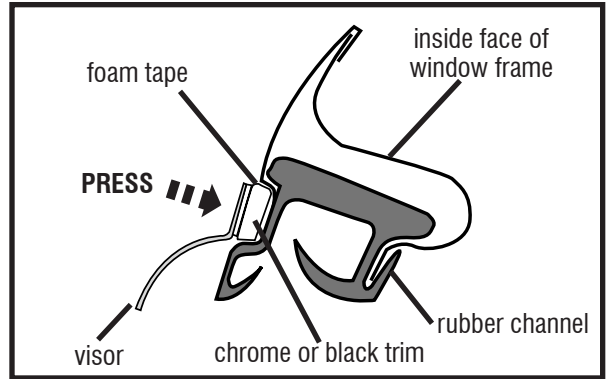

cross section of visor placement

4 Piece Set

The rear visor installs utilizing the same procedure as above. The front end flange attaches to the trim and the lateral flange to the vertical window post.

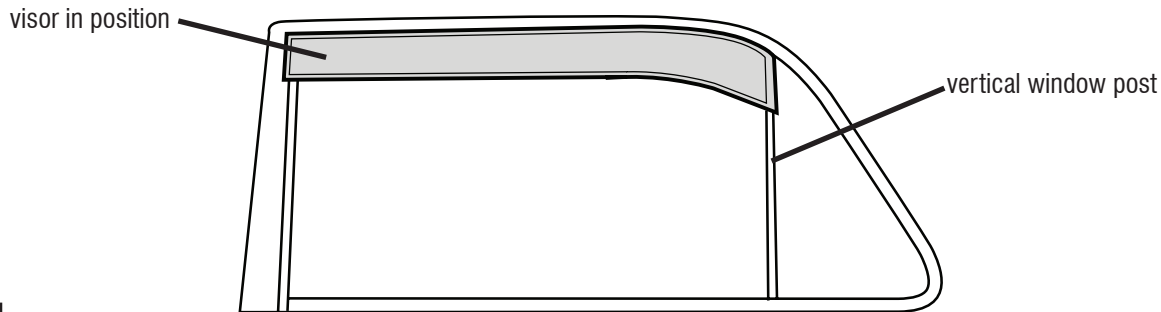

6

Repeat **Steps 1-6** for opposite side.

Care and Cleaning

- Wash only with mild soap & dry with a clean cloth.

Congratulations!

You have purchased one of the many quality Auto Ventshade™ branded products offered by Lund International, Inc. We take the utmost pride in our products and want you to enjoy years of satisfaction from your investment. We have made every effort to ensure that your product is top quality in terms of fit, durability, finish and ease of installation.



Lund International

800-241-7219 • Visit us at lundinternational.com

© 2012 Lund International, Inc. All rights reserved.

Auto Ventshade™, the Auto Ventshade™ logo and the AVS™ logo are trademarks of Lund International, Inc.





Ventvisor® Deflector

Pour obtenir une installation correcte et le meilleur ajustement possible, lire toutes les instructions AVANT de commencer.
 Pour toute assistance technique ou obtention de pièces manquantes, appeler le service des relations avec la clientèle au 1-800-241-7219.

Informations importantes concernant la sécurité



- ATTENTION – Avant de conduire, s'assurer que la visière est solidement assujettie sur le véhicule.
- Ne pas utiliser les stations de lavage de voitures à brosses.
- Ne pas utiliser de solvants.
- Vérifier régulièrement le serrage des composants.

Contenu - Ensemble 2 pièces

NOTE: Le produit réel peut changer de l'illustration.

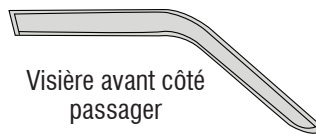
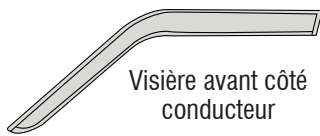

Tampons à l'alcool (2)

Contenu - Ensemble 4 pièces

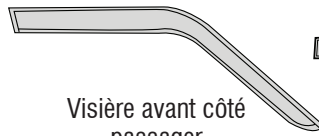

Tampons à l'alcool (4)

Outils nécessaires



Fournitures pour lavage de voiture



Serviette propre

Préparation pour la peinture/l'installation

- Il est recommandé de procéder à un essai pour s'assurer que le positionnement et l'ajustement sont corrects.
- Vérifier l'ajustement des pièces avant peinture, car nous n'acceptons pas le retour de pièces modifiées ou peintes.
- Laver les glissières de glaces de la portière du véhicule pour éliminer toute poussière et tous débris.
- Sécher les glissières avec une serviette propre.

Étapes d'installation

REMARQUE : La méthode d'application peut être légèrement différente de celle représentée par les illustrations.



Abaisser la glace du côté conducteur, puis nettoyer le cadre de glace et la garniture en chrome ou noir avec un tampon à l'alcool.

Garniture en chrome ou noir

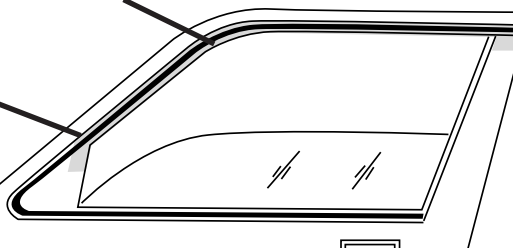

1

REMARQUE : Les visières se montent sur la garniture EXTÉRIÈRE de la portière.

Décoller 5 cm (2 po) de protection d'adhésif à chaque extrémité du rebord latéral.

Extrémité libre

Rebord latéral

Extrémité libre

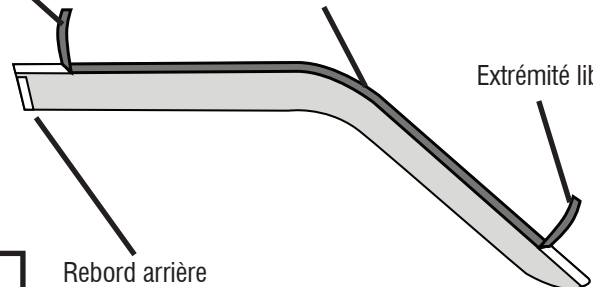

Rebord arrière

2

Étapes d'installation

REMARQUE : La méthode d'application peut être légèrement différente de celle représentée par les illustrations.

Aligner la visière et la portière. Les brides de la visière fixer à la surface de chrome ou noir de la fenêtre trim.

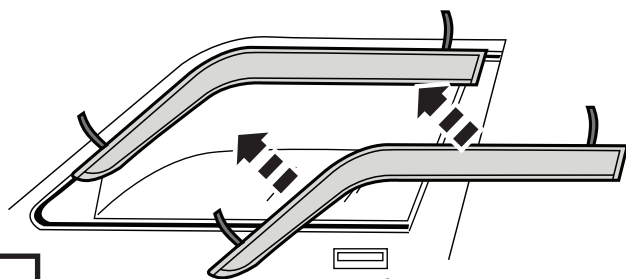

3

Vérifier le positionnement. Une fois la visière en position finale, retirer le reste de la protection d'adhésif en tirant sur les extrémités libres.

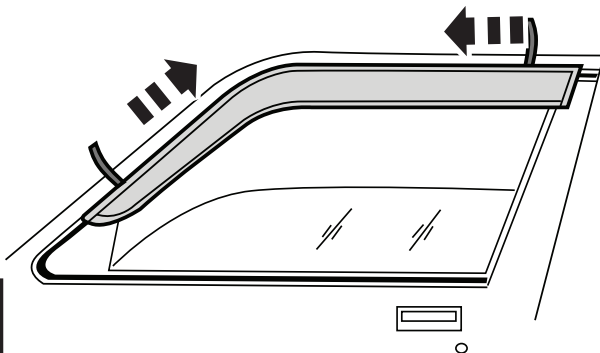

4

Appuyer le long de tous les rebords pour assurer la bonne adhésion du ruban sur les surfaces de la garniture.

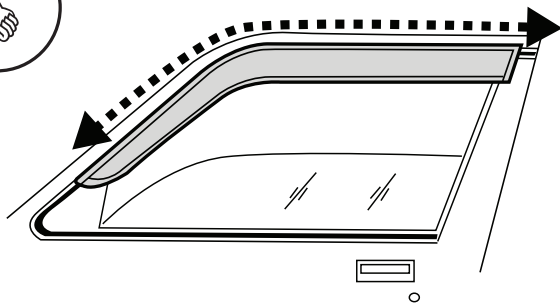

5

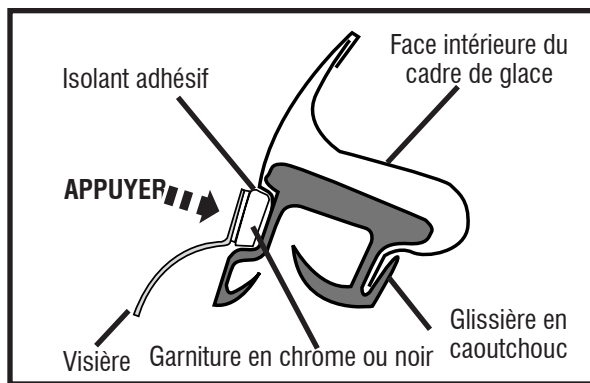

Coupe transversale de la mise en place de la visière

Ensemble 4 pièces

La visière arrière installée en utilisant la même procédure que ci-dessus. La bride d'extrémité avant attache à la garniture et la bride latérale de la fenêtre verticale poste.

visière en position

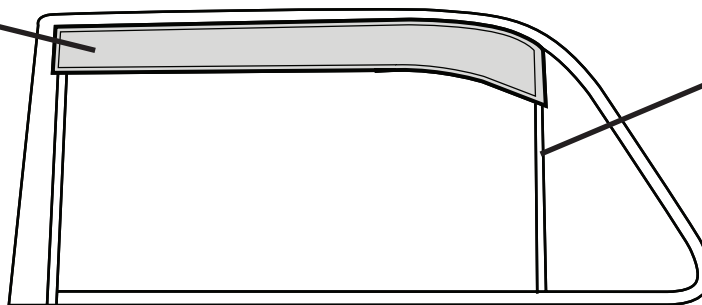

après fenêtre verticale

6

Répéter les étapes 1 à 6 pour le côté opposé.

Entretien et nettoyage

- Laver exclusivement avec de l'eau savonneuse et sécher avec un chiffon propre.

Félicitations !

Vous avez acheté l'un des nombreux produits de qualité Auto Ventshade™ fabriqués par Lund International, Inc. Nous sommes extrêmement fiers de nos produits et souhaitons que vous tiriez des années de satisfaction de votre investissement. Nous avons pris toutes les mesures nécessaires pour assurer que ce produit est d'une qualité supérieure en ce qui concerne l'ajustement, la durabilité, la finition et la facilité d'installation.



Lund International

800-241-7219 • Visitez notre site lundinternational.com

© 2012 Lund International, Inc. Tous droits réservés.



Auto Ventshade™, le logo Auto Ventshade™ et le logo AVS™ sont des marques déposées de Lund International, Inc.





Ventvisor® Deflector

Para una instalación adecuada y el mejor ajuste posible, lea todas las instrucciones ANTES de comenzar. Si desea recibir asistencia técnica u obtener piezas faltantes, llame al Servicio al cliente al 1-800-241-7219.

Información importante de seguridad



- **PRECAUCIÓN** - Antes de conducir, asegúrese de que la visera esté correctamente anclada al vehículo.
- No utilice servicios automáticos de limpieza de vehículos que utilizan cepillos.
- No utilice limpiadores al solvente de ningún tipo.
- Compruebe periódicamente que todos los componentes estén ajustados.

Contenido - Juego de dos piezas

NOTA: El producto real puede variar de la ilustración.



Visera delantera del conductor



Visera delantera del acompañante



Paños esterilizados x 2

Contenido - Juego de cuatro piezas



Visera delantera del conductor



Visera delantera del acompañante



Visera trasera del conductor



Visera trasera del acompañante



Paños esterilizados x 4

Herramientas necesarias



Equipo de limpieza de vehículos



Toalla limpia

Preparación antes de pintar o instalar

- Se recomienda realizar un ajuste de prueba para asegurar el posicionamiento y ajuste correctos.
- Compruebe que las piezas se ajusten correctamente antes de pintarlas, ya que no aceptaremos la devolución de piezas modificadas o pintadas.
- Lave los canales de la ventanilla del vehículo para quitar los desechos y la suciedad.
- Seque los canales de la ventanilla con una toalla limpia.

Pasos de instalación

AVISO: La colocación real puede variar con respecto a las ilustraciones.



Baje la ventanilla del conductor y limpie el marco de la ventanilla y la banda cromada o negro con un paño esterilizado.

banda cromada o negro



1

AVISO: Las viseras se montan en la banda **EXTERNA** de la puerta.

Retire 2" (5 cm) de cinta protectora de cada uno de los extremos del reborde lateral.

extremo libre

reborde lateral

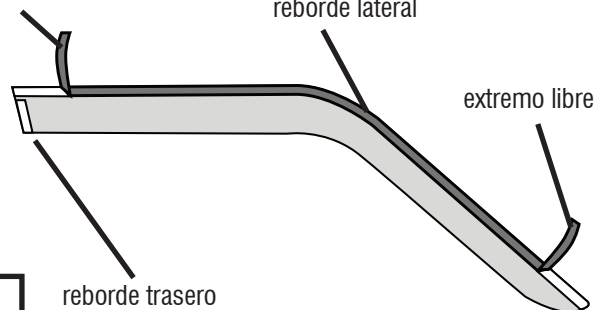

extremo libre

reborde trasero

2

Pasos de instalación

AVISO: La colocación real puede variar con respecto a las ilustraciones.

Alinee la visera con la puerta. Los rebordes de la visera adhieren a la superficie de cromo o negro de la ventana de corte.

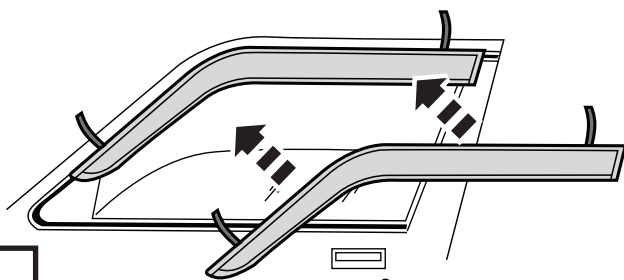

3

Verifique que esté correctamente colocada. Una vez que la visera se encuentre en su posición definitiva, quite la cinta protectora restante tirando de los extremos libres.

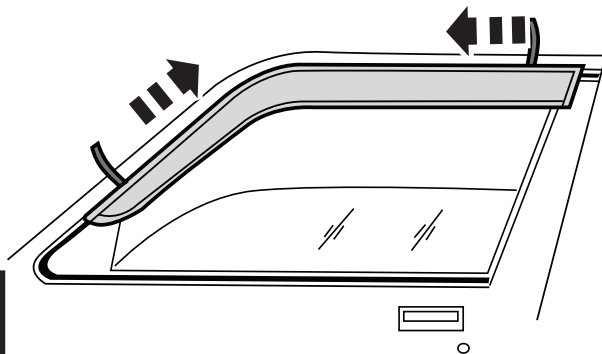

4

Presione todos los rebordes para asegurarse de que la cinta se adhiera a las superficies de la banda.

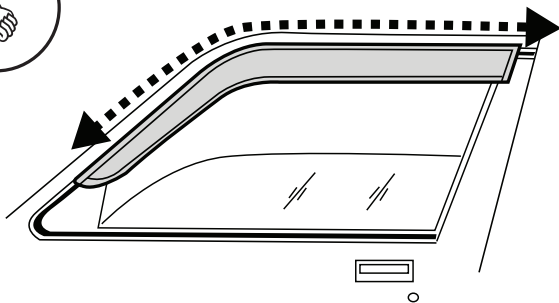

5

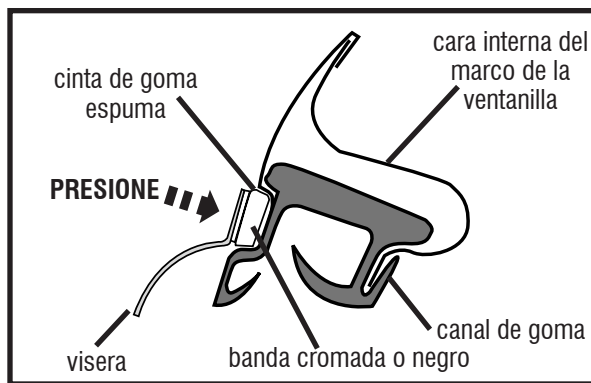

vista del corte transversal de la colocación de la visera

Juego de cuatro piezas

La visera trasera instala utilizando el mismo procedimiento que el anterior. La brida de extremo frontal se une a la moldura y la pestaña lateral al poste ventana vertical.

visera en posición

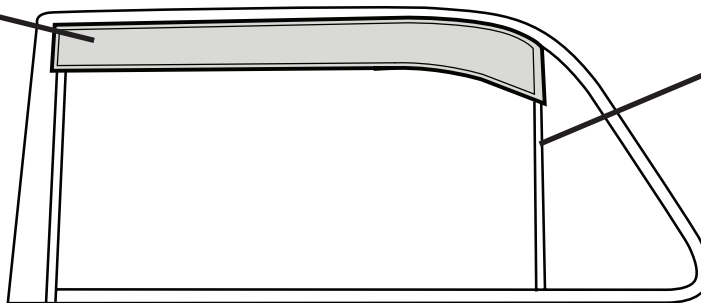

después de ventana vertical

6

Repita los Pasos 1 al 6 para el otro lado del vehículo.

Cuidado y limpieza

- Limpie solamente con agua jabonosa tibia y seque con un paño limpio.

Felicidades

Usted ha comprado uno de los tantos artículos de calidad de Auto Ventshade™ ofrecidos por Lund International, Inc. Nuestros productos son nuestro mayor orgullo. Deseamos que disfrute de años de satisfacción con su inversión. Hemos realizado todos los esfuerzos para asegurarnos de que su producto sea de la mejor calidad en cuanto a ajuste, durabilidad, acabado y facilidad de instalación.



Lund International

800-241-7219 • Visite nuestro sitio Web: lundinternational.com

© 2012 Lund International, Inc. Todos los derechos reservados.



Auto Ventshade™, el logo de Auto Ventshade™ y el logo de AVS™ son marcas comerciales de Lund International, Inc.

