



Ventvisor® Deflector

For proper installation and best possible fit, please read all instructions BEFORE you begin. For technical assistance or to obtain missing parts, please call Customer Relations at 1-800-241-7219.

Important Safety Information



- CAUTION - Before driving, ensure that the vent visor is properly secured to vehicle.
- Do not use automatic "brush-style" car washes.
- Do not use cleaning solvents of any kind.
- Periodically check all components for tightness.

Contents - 2 Piece Set **NOTE:** Actual product may vary from illustration.



Front Driver Side Visor



Front Passenger Side Visor

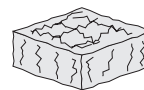

Scotch Brite Pad



Alcohol Pad x2

Contents - 4 Piece Set



Front Driver Side Visor



Front Passenger Side Visor



Rear Driver Side Visor

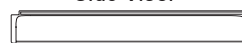

Rear Passenger Side Visor

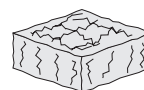

Scotch Brite Pad



Alcohol Pad x4

Tools Required



Car Wash Supplies



Clean Towel

Preparation Before Painting / Installation

- A trial fit is recommended to ensure proper positioning and fit.
- Check fit of parts before painting as we will not accept the return of modified or painted parts.
- Wash and dry your vehicle to remove any debris and/or dirt from the installation area.

Installation Steps **NOTE:** Actual application may vary slightly from illustrations.



Roll down window. Buff the inside felt surface with scotch brite pad. Then clean with alcohol pad.

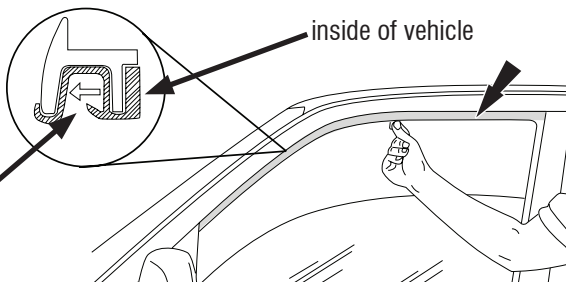

1

NOTE: visors mount on the **inside** of the window channel.

Remove tape liner from front flange. Peel back 2" of tape liner from each end of top flange.

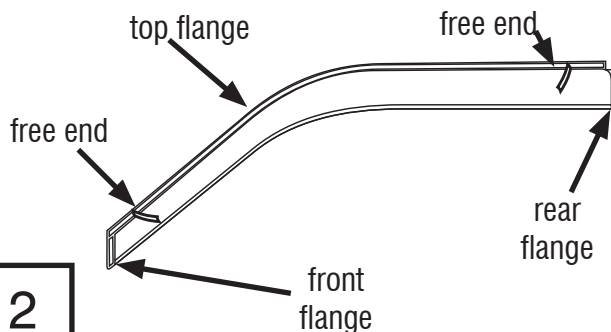

2

Installation Steps

NOTE: Actual application may vary slightly from illustrations.

Insert visor rear flange first. Rear flange inserts between the trim and the exterior surface. The front & top flange slides into the window channel.

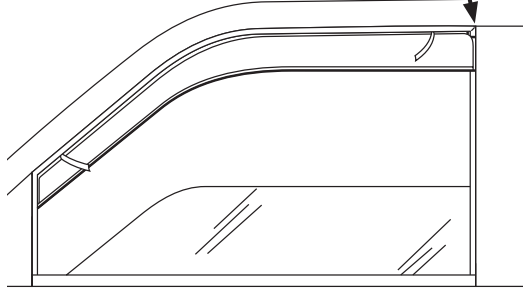
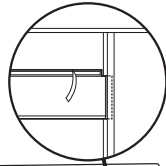

3

Apply pressure to all flange edges to ensure proper adhesion. Remove tape liner by pulling on free ends.

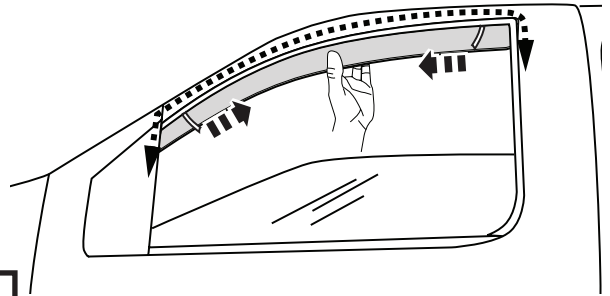

4

NOTE: It is necessary to both hold the visor up into the window channel **AND** pull the bottom of the visor slightly outward while raising the glass to seat visor properly.

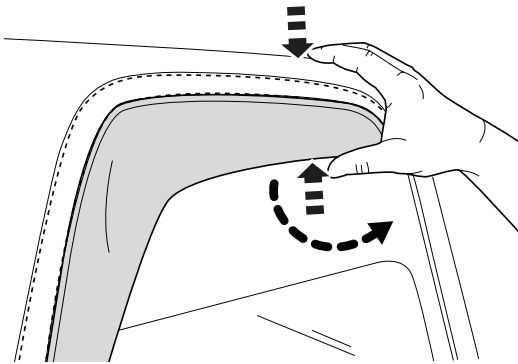

5

Continue to apply pressure to ensure that the visor remains properly seated inside the window channel as window is slowly closed. Leave window up for 72 hours to secure visor to window channel.



50°F / 10°C Min.

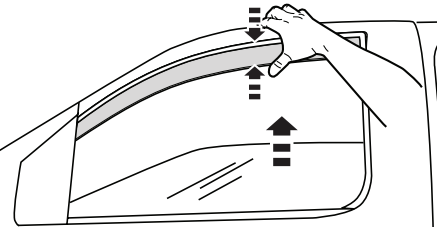

6

If the visor does not seat correctly, roll down window and repeat **Step 5**.

4 Piece Set

Install the rear visor using the same preparation and installation methods as front visor. Note that the top & rear flanges slide into the window channel, and the front flange fits between the rubber & window frame.

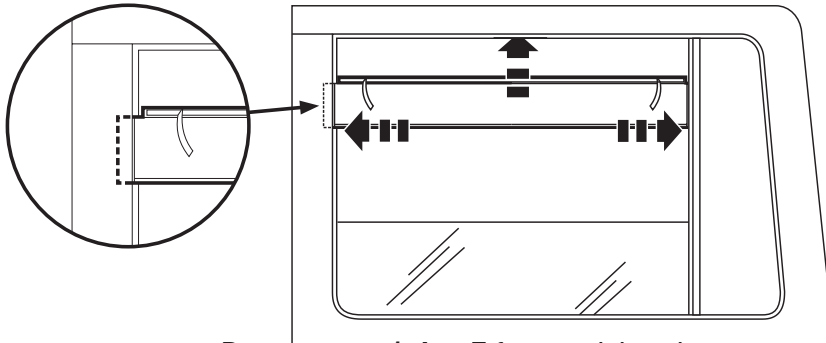

7

Repeat steps 1 thru 7 for remaining visors

Care and Cleaning

- Wash only with mild soap & dry with a clean cloth.

Congratulations!

You have purchased one of the many quality Auto Ventshade™ branded products offered by Lund International, Inc. We take the utmost pride in our products and want you to enjoy years of satisfaction from your investment. We have made every effort to ensure that your product is top quality in terms of fit, durability, finish and ease of installation.



Lund International

800-241-7219 • Visit us at lundinternational.com

© 2016 Lund International, Inc. All rights reserved.

Auto Ventshade™, the Auto Ventshade™ logo and the AVS™ logo are trademarks of Lund International, Inc.





Ventvisor® Deflector

Pour obtenir une installation correcte et le meilleur ajustement possible, lire toutes les instructions AVANT de commencer.
 Pour toute assistance technique ou obtention de pièces manquantes, appeler le service des relations avec la clientèle au 1-800-241-7219.

Informations importantes concernant la sécurité



- ATTENTION – Avant de conduire, s'assurer que la visière est solidement assujettie sur le véhicule.
- Ne pas utiliser les stations de lavage de voitures à brosses.
- Ne pas utiliser de solvants.
- Vérifier régulièrement le serrage des composants.

Contenu - Ensemble 2 pièces

NOTE: Le produit réel peut changer de l'illustration.

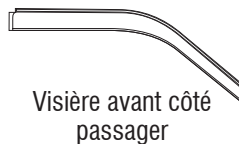

Contenu - Ensemble 4 pièces

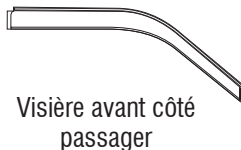

Outils nécessaires



Fournitures pour lavage de voiture



Serviette propre

Préparation pour la peinture/l'installation

- Il est recommandé de procéder à un essai pour s'assurer que le positionnement et l'ajustement sont corrects.
- Vérifier l'ajustement des pièces avant peinture, car nous n'acceptons pas le retour de pièces modifiées ou peintes.
- Laver les glissières de glaces de la portière du véhicule pour éliminer toute poussière et tous débris.
- Sécher les glissières avec une serviette propre.

Étapes d'installation

REMARQUE : La méthode d'application peut être légèrement différente de celle représentée par les illustrations.



Abaissez la glace. Polissez la surface de feutre intérieure avec un tampon Scotch Brite. Nettoyez-a ensuite avec un tampon à l'alcool.

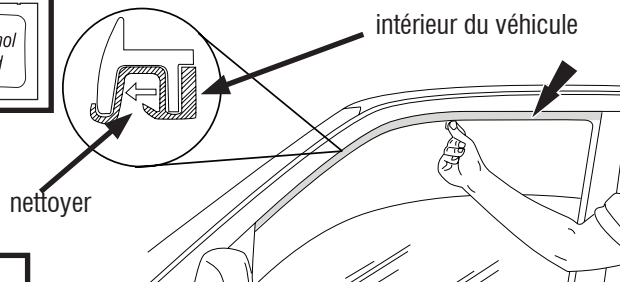

1

REMARQUE : Les visières se montent à l'intérieur de la glissière de la glace.

Retirer la protection d'adhésif du rebord avant. Décoller 5 cm (2 po) de protection d'adhésif à chaque extrémité du rebord supérieur.

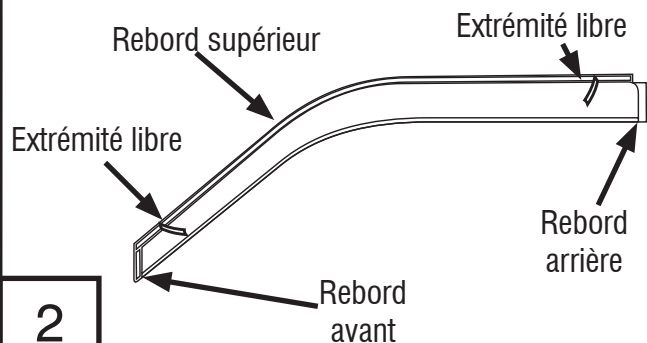

2

Étapes d'installation

REMARQUE : La méthode d'application peut être légèrement différente de celle représentée par les illustrations.

Insérez la bride arrière de la visière première. Le rebord arrière s'insère entre la garniture de glace et la surface extérieure. Les rebords avant et supérieur s'engagent dans la glissière de glace.

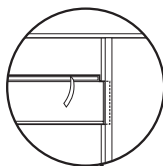

3

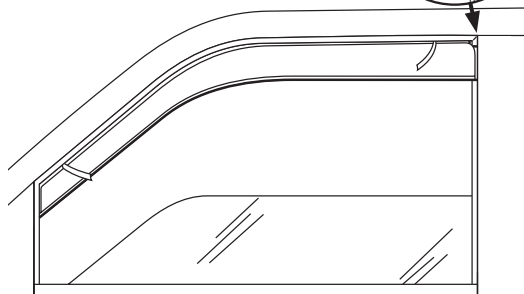

Exercez une pression sur tous les bords des brides afin de vous assurer que la pièce colle bien. Retirer la protection d'adhésif en tirant sur les extrémités libres.

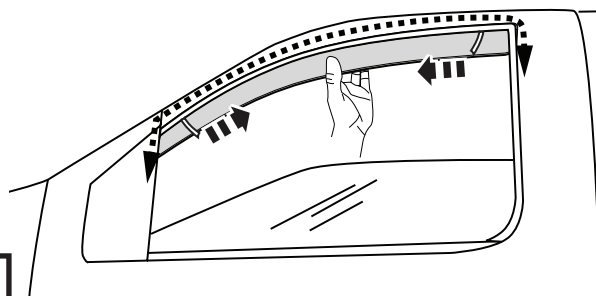

4

NOTE: Il faut à la fois tenir la visière en place dans le canal de la fenêtre et tirer le bas de la visière légèrement vers l'extérieur tout en augmentant le verre à visière siège correctement.

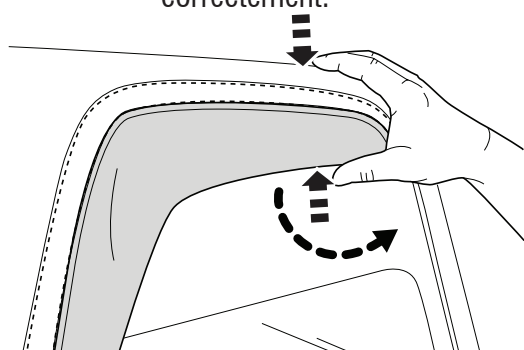

5

Relevez la glace lentement et laissez-la dans cette position pendant 72 heures pour bien fixer le pare-soleil au canal de la glace. **Remarque :** Il peut être nécessaire d'imprimer un mouvement de va-et-vient à la glace pour la fermer au départ.

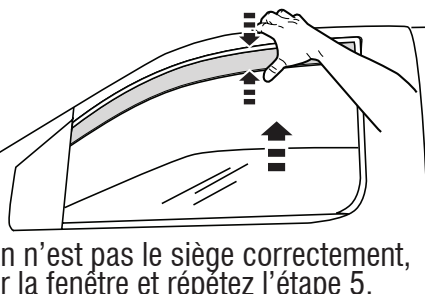
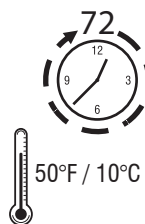

6

Si l'écran n'est pas le siège correctement, rouler la fenêtre et répétez l'étape 5.

Ensemble 4 pièces

Installer la visière arrière en utilisant la même méthode de préparation et d'installation que pour la visière avant. Noter que les rebords supérieur et arrière s'engagent en glissant dans la glissière de la glace, et que le rebord avant s'insère entre le caoutchouc et le cadre de glace.

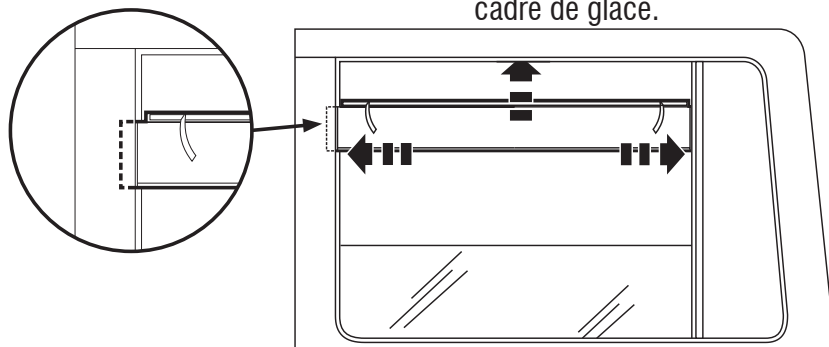

7

Répéter les étapes 1 à 7 pour les visières restantes

Entretien et nettoyage

- Laver exclusivement avec de l'eau savonneuse et sécher avec un chiffon propre.

Félicitations !

Vous avez acheté l'un des nombreux produits de qualité Auto Ventshade™ fabriqués par Lund International, Inc. Nous sommes extrêmement fiers de nos produits et souhaitons que vous tiriez des années de satisfaction de votre investissement. Nous avons pris toutes les mesures nécessaires pour assurer que ce produit est d'une qualité supérieure en ce qui concerne l'ajustement, la durabilité, la finition et la facilité d'installation.



Lund International

800-241-7219 • Visitez notre site lundinternational.com

© 2016 Lund International, Inc. Tous droits réservés.



Auto Ventshade™, le logo Auto Ventshade™ et le logo AVS™ sont des marques déposées de Lund International, Inc.





Ventvisor® Deflector

Para una instalación adecuada y el mejor ajuste posible, lea todas las instrucciones ANTES de comenzar. Si desea recibir asistencia técnica u obtener piezas faltantes, llame al Servicio al cliente al 1-800-241-7219.

Información importante de seguridad



- PRECAUCIÓN - Antes de conducir, asegúrese de que la visera esté correctamente anclada al vehículo.
- No utilice servicios automáticos de limpieza de vehículos que utilizan cepillos.
- No utilice limpiadores al solvente de ningún tipo.
- Compruebe periódicamente que todos los componentes estén ajustados.

Contenido - Juego de dos piezas

NOTA: El producto real puede variar de la ilustración.

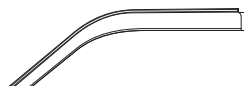

Visera delantera del conductor

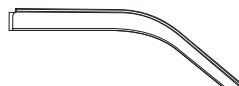

Visera delantera del acompañante



Paño Scotch Brite



Paños esterilizados x 2

Contenido - Juego de cuatro piezas



Visera delantera del conductor

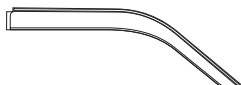

Visera delantera del acompañante



Visera trasera del conductor



Visera trasera del acompañante

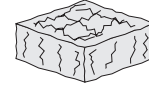

Paño Scotch Brite



Paños esterilizados x 4

Herramientas necesarias



Equipo de limpieza de vehículos



Toalla limpia

Preparación antes de pintar o instalar

- Se recomienda realizar un ajuste de prueba para asegurar el posicionamiento y ajuste correctos.
- Compruebe que las piezas se ajusten correctamente antes de pintarlas, ya que no aceptaremos la devolución de piezas modificadas o pintadas.
- Lave los canales de la ventanilla del vehículo para quitar los desechos y la suciedad.
- Seque los canales de la ventanilla con una toalla limpia.

Pasos de instalación

AVISO: La colocación real puede variar con respecto a las ilustraciones.



Baje la ventanilla. Pule la superficie de fieltro con un paño para restregar Scotch Brite. Luego limpie con un paño esterilizado.

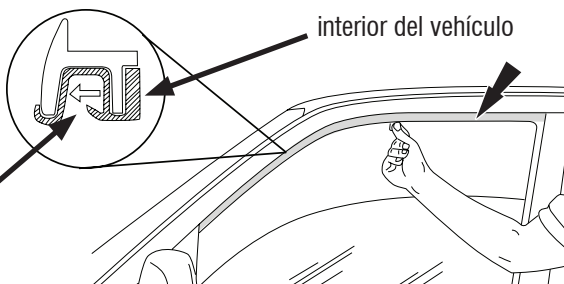

1

AVISO: las viseras se colocan en la parte interior del canal de la ventanilla.

Quite la cinta protectora del reborde frontal. Retire 2 pulgs. (5 cm) de cinta protectora de cada uno de los extremos del reborde superior.

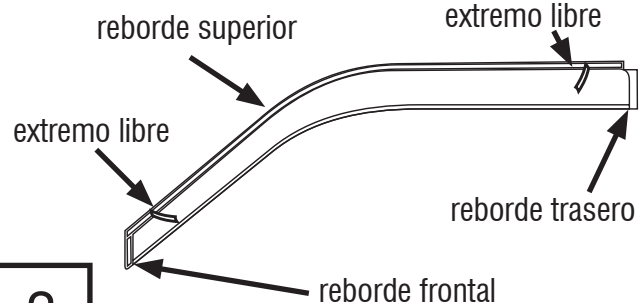

2

Pasos de instalación

AVISO: La colocación real puede variar con respecto a las ilustraciones.

Insertar pestaña trasera visera primero. El reborde trasero se introduce entre la banda lateral y la superficie exterior. El reborde superior frontal se desliza por el canal de la ventanilla.

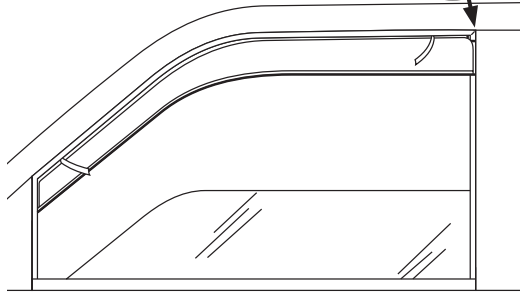
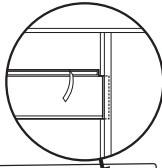

3

Ejerza presión en todos los bordes del reborde para que se adhiera correctamente. Retire la cinta protectora tirando de los extremos libres.

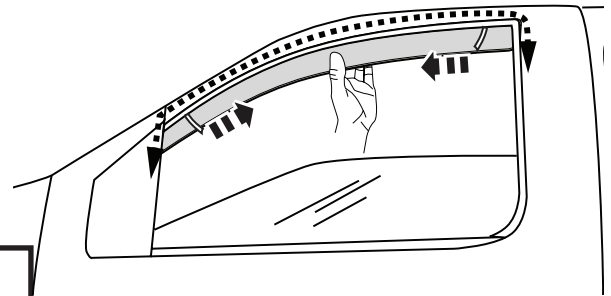

4

NOTA: Es necesario tanto para mantener la visera hacia arriba en el canal de la ventana y tire de la parte inferior de la visera ligeramente hacia fuera mientras levanta la copa a la visera asiento correctamente.

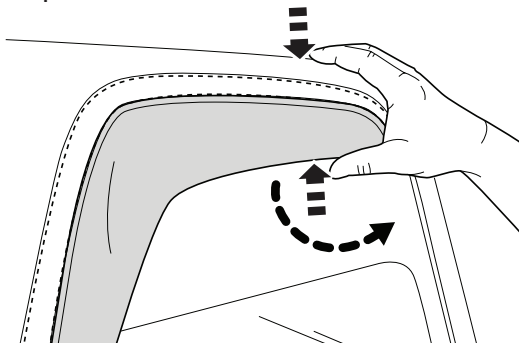

5

Continúe aplicando presión para asegurarse de que el visor encaje correctamente dentro del canal de la ventana ya que la ventana se cierra lentamente. Suba la ventana durante 72 horas para asegurar el visor en el canal de la ventana.

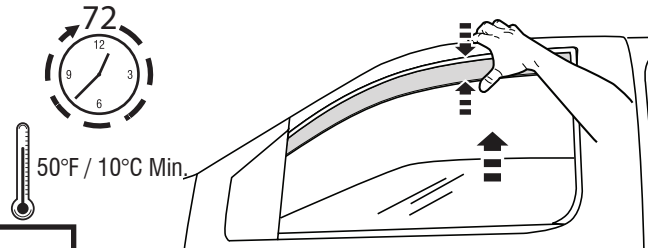

6

Si el visor no se sienta correctamente, baje la ventana y repita el paso 5.

Juego de cuatro piezas

Instale la visera trasera con los mismos métodos de preparación e instalación que utilizó para la visera frontal. Tenga en cuenta que los rebordes superior y trasero se adhieren al canal de la ventanilla y el reborde frontal se inserta entre la goma y el marco de la ventanilla.

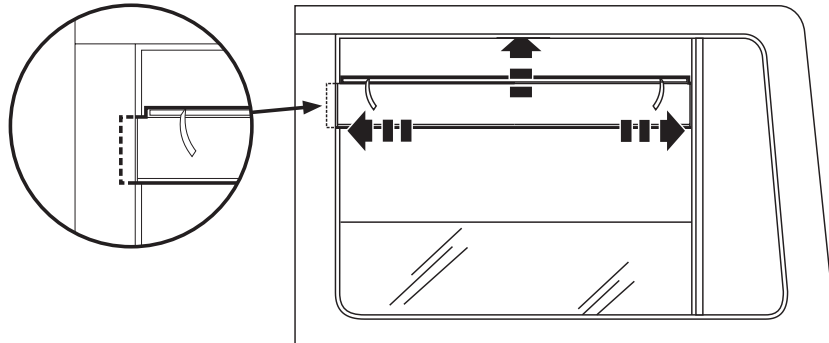

7

Repita los **pasos 1 a 7** en el lado del pasajero.

Cuidado y limpieza

- Limpie solamente con agua jabonosa tibia y seque con un paño limpio.

Felicidades

Usted ha comprado uno de los tantos artículos de calidad de Auto Ventshade™ ofrecidos por Lund International, Inc. Nuestros productos son nuestro mayor orgullo. Deseamos que disfrute de años de satisfacción con su inversión. Hemos realizado todos los esfuerzos para asegurarnos de que su producto sea de la mejor calidad en cuanto a ajuste, durabilidad, acabado y facilidad de instalación.



Lund International

800-241-7219 • Visite nuestro sitio Web: lundinternational.com

© 2016 Lund International, Inc. Todos los derechos reservados.



Auto Ventshade™, el logo de Auto Ventshade™ y el logo de AVS™ son marcas comerciales de Lund International, Inc.

