



Installation Instructions 2 Piece Soft Doors

Vehicle Application:
Toyota Land Cruiser FJ-40 1964-1984
Part Number 51774

Installation Tips

Before you begin installing your new Soft Doors, please read all the instructions thoroughly.

For easier installation, the top should be installed at a temperature above 72° F. Below this temperature, the fabric may contract making it difficult to fit the vehicle.

⚠ WARNING Do not rely in any way on the components of this product to protect against injury or death in the event of an accident. Never operate the vehicle in excess of manufacturer’s specifications.





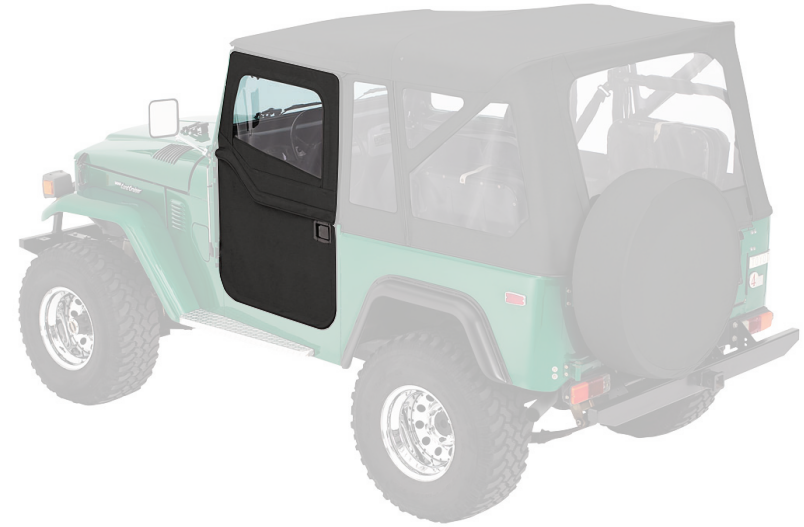





Read and follow, precisely, all installation instructions provided when installing this product. Failure to do so may result in a poor fit and could place occupants of the vehicle in a potentially dangerous situation.

For a smooth fit;
The Softtop needs to be in the up position while installing the doors. It is normal for the fabric to contract and wrinkle when stored in the shipping carton. Within a few days after the installation, the fabric will relax and the wrinkles will disappear.



⚠ CAUTION Safety glasses should be worn at all times when installing this product.

WEAR SEAT BELTS AT ALL TIMES

Tools				Installation Time		Support	
				1 00		<p>We're here to help! Go to www.Bestop.com and click on "Need Help?"</p>	
Safety Glasses	Power Drill	3/16" Drill bit	Pencil	1 Hours			
				Skill Level			
Adjustable Wrench	Center Punch	Phillips Screw Driver		   			
				4 - Difficult			



Installation Instructions

2 Piece Soft Doors

Vehicle Application:
Toyota Land Cruiser FJ-40 1964-1984
Part Number 51774

Sugerencias de Instalación

Antes de empezar a instalar esta unidad, lea atentamente todas las instrucciones.

Para un buen ajuste:

Para facilitar la instalación, el producto debe instalarse a temperaturas superiores a 72 °F (22 °C).

Por debajo de esta temperatura, la tela puede encogerse una pulgada o más, lo que dificultaría su ajuste al vehículo.

Es normal que la tela se contraiga o arrugue cuando está guardada en la caja de empaque. A los pocos días después de la instalación, la tela se relajará y las arrugas desaparecerán.



ADVERTENCIA

Este producto se diseñó principalmente para mejorar la apariencia del vehículo y proteger a los ocupantes de las condiciones climáticas comunes. De ninguna manera piense que los componentes de este producto pueden servir como medio de contención para los ocupantes del vehículo o que pueden protegerlos contra lesiones o la muerte en caso de accidente. Este producto no protegerá a los ocupantes contra caídas de objetos. Nunca conduzca este vehículo fuera de las especificaciones del fabricante.

USE LOS CINTURONES DE SEGURIDAD EN TODO MOMENTO

Lea y siga con precisión todas las instrucciones de instalación que se proporcionan para instalar este producto. Si no lo hace, podría producirse un mal ajuste que colocaría a los ocupantes del vehículo en una situación potencialmente peligrosa.



PRECAUCIÓN

Debe usar gafas protectoras en todo momento durante la instalación de este producto.

Conseils pour l'installation

Lire toutes les instructions au complet avant de commencer l'installation de cet assemblage.

Pour un ajustement sans problème :

Afin de faciliter l'installation, ce produit doit être installé à des températures au-dessus de 72 °F (22 °C).

Sous cette température, le tissu peut rétrécir d'un pouce (2,5 cm) ou plus, ce qui rendra l'ajustement sur le véhicule difficile.

Il est normal que le tissu rétrécisse et plisse pendant qu'il est dans la boîte d'expédition. En quelques jours après l'installation, le tissu se détendra et les plis disparaîtront.



AVERTISSEMENT

Ce produit est conçu principalement pour améliorer l'apparence du véhicule et pour protéger les occupants des conditions météorologiques usuelles. Ne jamais se fier aux composants de ce produit pour se protéger de blessures ou de la mort en cas d'accident. Ce produit ne protégera pas les occupants des chutes d'objets. Ne jamais utiliser le véhicule au-delà des caractéristiques techniques indiquées par le fabricant.

PORTER UNE CEINTURE DE SÉCURITÉ EN TOUT TEMPS

Lire et suivre, très fidèlement, toutes les instructions d'installation fournies lors de l'installation de ce produit. Ne pas suivre cette consigne peut causer une installation inadéquate et mettre les occupants du véhicule dans une situation potentiellement dangereuse.



MISE EN GARDE

Des lunettes de sécurité doivent être portées en tout temps lors de l'installation de ce produit.

Parts List and Hardware Identification

- Door, Upper - Right Qty - 1
- Door, Upper - Left Qty - 1
- Door, Lower - Right Qty - 1
- Door, Lower - Left Qty - 1

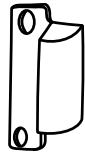

- Door Striker, Part Number 256.30, Qty - 2

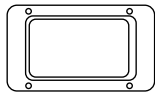

- Paddle Handle - Door, Part Number 245.46, Qty - 2

		<input type="checkbox"/> #10-24 x 3/8" Truss Head Machine Screw - Black, Qty - 8, Part Number 195.92
		<input type="checkbox"/> #14 Sheet Metal Screw, Part Number 243.47, Qty - 4
		<input type="checkbox"/> #10-24 Locknut, Qty - 8, Part Number 195.93
		<input type="checkbox"/> 1/8" Allen Wrench, Qty - 1, Part Number 276.68

Hardware Installation

Step One

Windshield Adjustment

Measure and record the distance from the top inside edge of the windshield to the top outer edge of the vehicle body. Take the measurement from approximately six inches inside the vehicles doors. Check to make sure that both sides measure equally. To install this top properly, this measurement must be 81".

Adjust your windshield by loosening the Windshield Clamps and adjusting the brackets. You may then lean the windshield forward or back as necessary. Use a shim to fix the windshield in place if it remains loose after you tighten the screws.

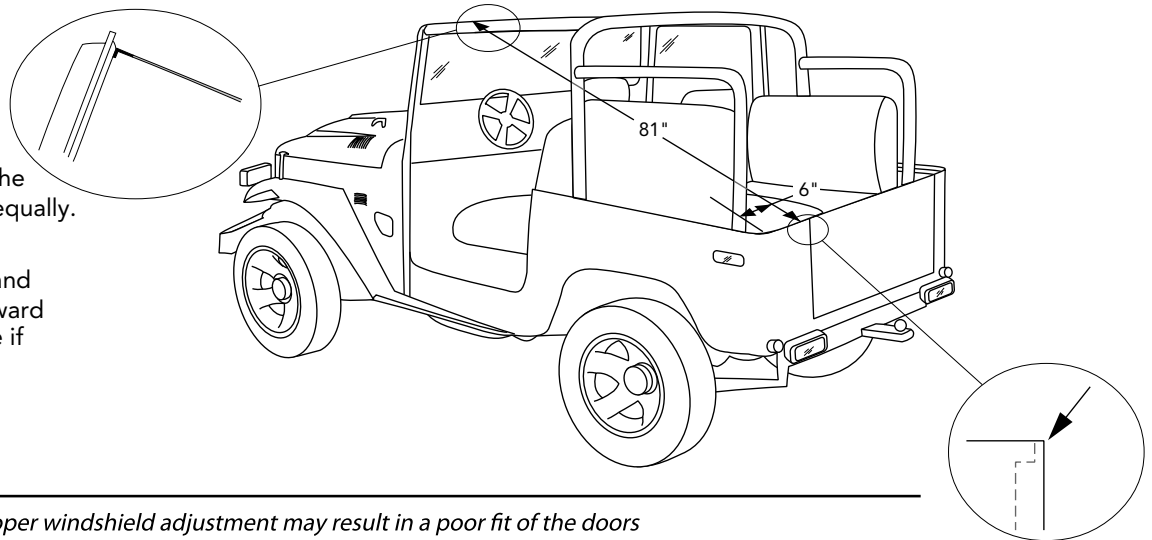

Note: This is a very important step in the installation process. Improper windshield adjustment may result in a poor fit of the doors

Step Two

Install Paddle Handles

Locate the pre-cut "X" in the lower door panel where the Paddle Handle will fit into the mounting plate on the door frame. Fold the pre-cut fabric back and insert the Paddle Handle into the mounting plate so that the latch mechanism is inside of the vehicle. Align the four holes in the Paddle Handle Assembly with the four holes in the mounting plate. Use a pointed tool to punch four holes in the fabric to match the holes in the Paddle Handle and the mounting plate. Insert four #10-24 Truss Head Machine Screws from the outside and secure them with #10-24 Locknuts. Do not fully tighten the screws at this time. Trim the excess fabric around the Paddle Handle Repeat for both lower doors.

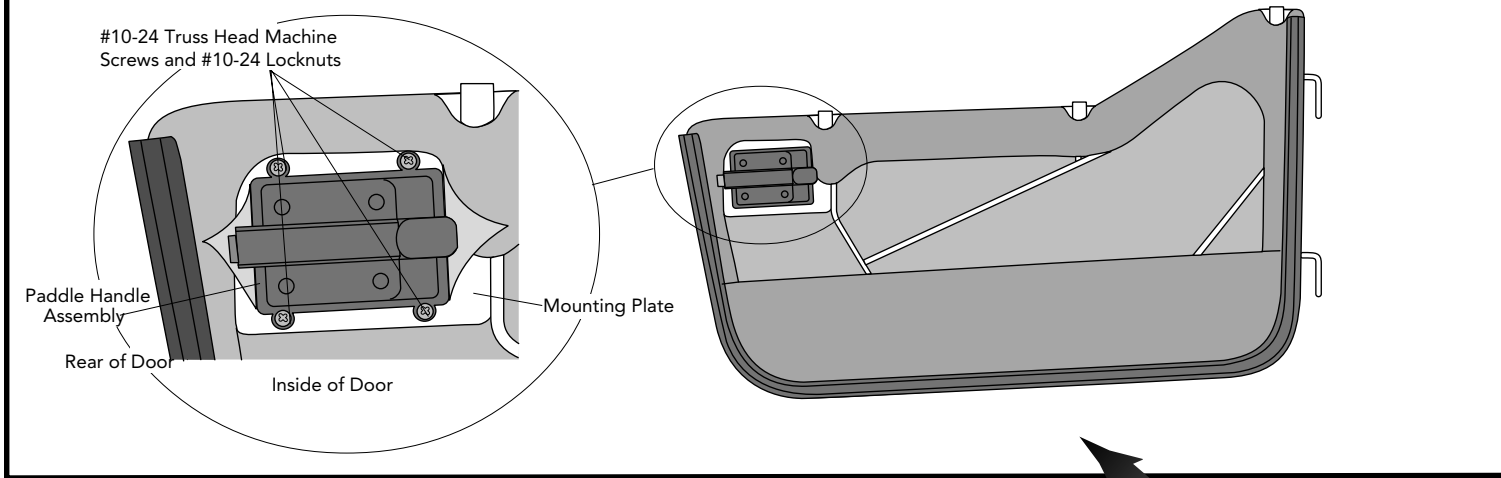

Step Three

Install Lower Doors

Hold the door straight out from the vehicle with the hinge pins over the body hinges. Lower the pins into the hinges. Make sure that the pins are fully inserted into the body hinges. Close the door and check all sides to make sure that it fits properly against the body.

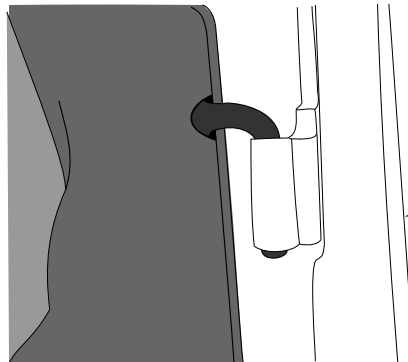

Note: Remove the black protective covers from the pins before installing the doors.

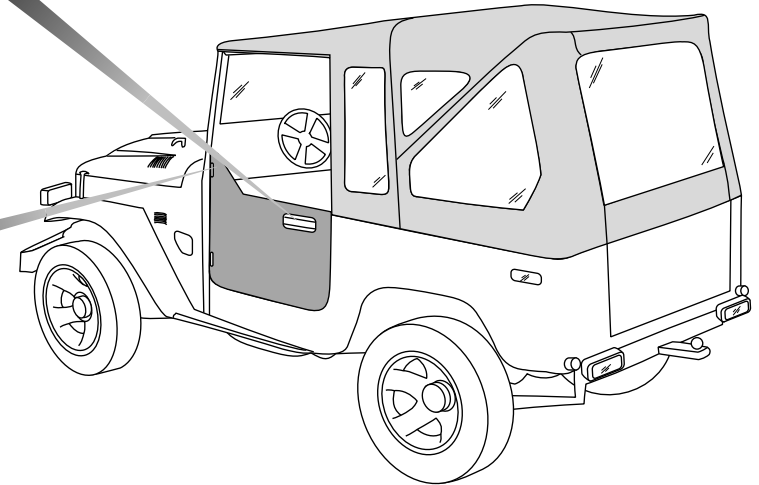

Step Four

Install Door Strikers

Close the door against the body and place a Door Striker on the body aligned with the Paddle Handle Latch. Mark the center of the slots in the striker. Center punch the marks and drill a 3/16" hole at each location. Use two #14 Sheet Metal Screws to install the Door Striker. The Door Strikers may be adjusted in or out until you are satisfied with the way the door shuts and opens. Tighten the #10-24 Truss Head Machine Screws on the Paddle Handle. You may need to adjust the paddle handle to improve the fit. Repeat this for the other door.

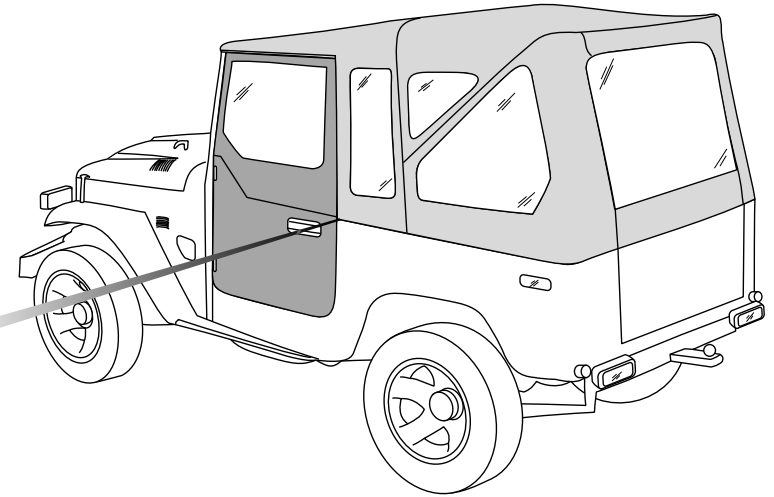
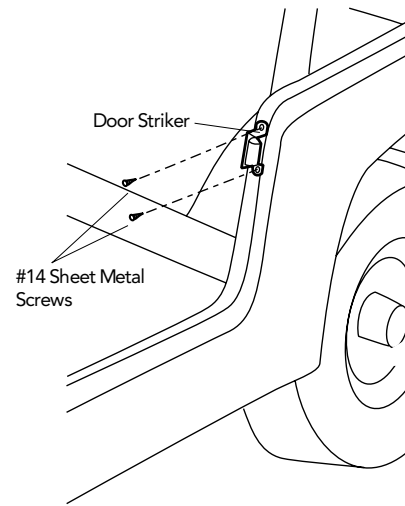

Note: If a hard door striker is present, it must be removed.

Note: Some vehicles will use the existing holes and bolts from the hard door striker.

Step Five

Install the upper door into the lower door. Starting with the front pin, slip the pins into the sockets in the lower door. Make sure that the pins are well seated in the sockets. Close the door to check that it fits properly against the body. If necessary, use the 1/8" Allen Wrench, provided in the parts kit, to loosen the Collars on the front and rear upper door pins. The Collars will slide up or down as needed to provide the best fit of the Upper Door against the windshield. Attach the loop strip on the bottom of the upper door to the hook strip on the top of the lower door. If necessary for proper door fit, bend the door slightly.

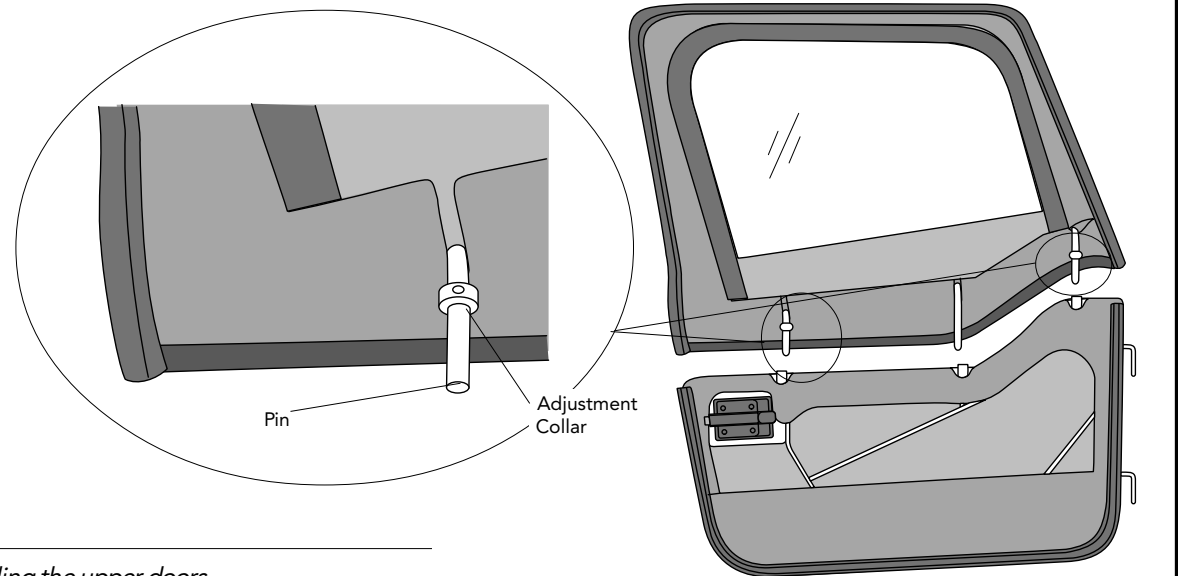

Note: Remove the red protective covers from the pins before installing the upper doors.

Note: Lubricating the upper door pins with a light weight oil will make it easier to install and remove the upper door.

Care and Maintenance of your Bestop Top

Your top is made of the finest materials available. To keep it looking new and for the maximum possible wear, it will need periodic cleaning and maintenance.

Washing: The top fabric should be washed often using soap, warm water and a soft bristle brush. Rinse with clear water to remove all traces of soap.

Windows: Keep windows clean to avoid scratching. **DO NOT** use a brush on the windows! Wash with a watersoaked cloth or sponge and a mild dishwashing detergent. **NEVER WIPE THE WINDOWS WHEN THEY ARE DRY.** Be careful when cleaning snow or frost from the vinyl windows since they are easily scratched and may crack at low temperatures. **DO NOT** roll the sides or rear window in cold weather. The windows become stiff and will crack.

Zippers: Keeping the zipper cleaned and lubricated with a silicone lubricant will help prevent damage and keep the zippers in a smooth working condition. If a zipper opens behind the slider, the slider may have been spread apart. This problem can usually be repaired by using an ordinary pair of pliers to bring the sides back into parallel. Return slider to the end of the zipper in the normal Open position. Squeeze lightly at first and test the zipper. If the zipper continues to remain open squeeze more firmly with the pliers and try the zipper again. Repeat this procedure until the zipper operates correctly.

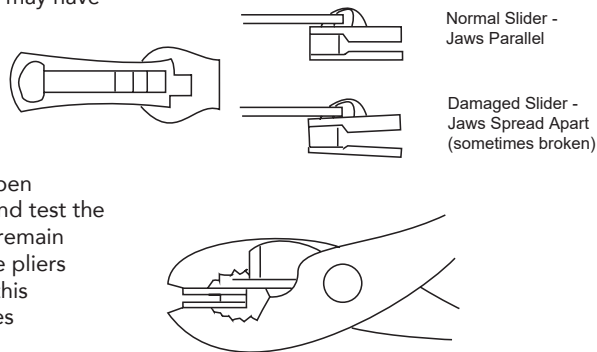

Water: Seeping through at the seams may be stopped by applying 3-M Scotchgard® on the inside of the seams. Rips in the fabric may be repaired with Bondex® iron on patches. Iron the patches to the Inside of the top, carefully following the Bondex® instructions.

Snaps: Keep snaps cleaned and lubricated with silicone to help prevent snaps from sticking to the studs. If a snap does become stuck to a stud, use a screwdriver and GENTLY pry apart to prevent permanent damage to the snap or the top fabric.



Installation Instructions

2 Piece Soft Doors

Vehicle Application:
Toyota Land Cruiser FJ-40 1964-1984
Part Number 51774

WHAT BESTOP WARRANTS

Subject to the terms and conditions of sale, including any terms and conditions set forth by Bestop, Inc. ("Bestop" or "us" or "we") in our then-current terms of sale on our website (collectively, the "Terms"), Bestop represents and warrants that: the covered products listed in the "Covered Products and Warranty Periods" section (a "Product") will substantially be free from defects in materials and workmanship for the specified warranty periods set forth in that section.

THE WARRANTY IS LIMITED AND CONDITIONAL

This warranty applies to the original purchaser of the Product only. The warranty is valid only as long as the original retail purchaser owns the vehicle upon which the Product is installed. The warranty expires should the Product be removed from the original vehicle or if the original vehicle is transferred to another owner.

This warranty is not transferable or assignable. The warranty does not apply to Product bought from auction-style or price-bid websites.

THE LIMITED WARRANTY AND STATED REMEDIES ARE SOLE AND EXCLUSIVE AND IN LIEU OF ALL OTHER WARRANTIES AND REMEDIES, AND COMPANY EXPRESSLY DISCLAIMS ALL IMPLIED OR STATUTORY OR OTHER WARRANTIES, INCLUDING WITHOUT LIMITATIONS WARRANTIES OF MERCHANTABILITY, NON-INFRINGEMENT OR FITNESS FOR A PARTICULAR PURPOSE. IN NO EVENT WILL COMPANY BE LIABLE FOR ANY SPECIAL, INCIDENTAL, CONSEQUENTIAL, PUNITIVE, INDIRECT OR EXEMPLARY DAMAGES OF ANY KIND, INCLUDING LOST PROFITS OR REVENUE, HOWEVER CAUSED, WHETHER FOR BREACH OR REPUDIATION OF CONTRACT, TORT, BREACH OF WARRANTY, NEGLIGENCE, OR OTHERWISE, WHETHER OR NOT COMPANY WAS ADVISED OF THE POSSIBILITY OF SUCH LOSS OR DAMAGES.

Some states do not allow exclusion or limitation, so this may not apply to you. This warranty gives you specific legal rights, and you may have other rights which vary from state to state.

EXCLUSIONS TO THE WARRANTY

The Limited Warranty excludes, and Bestop is not liable in any way for any warranty claims, damages, or defects related to:

- Misuse, abuse, accidents, vandalism, negligence, fire, or improper installation or modification, or improper or inadequate maintenance;
- Failure to comply with any Product documentation, Bestop instructions, or applicable law or regulations; use in extreme conditions
- Force Majeure including but not limited to, earthquake, hurricane, tornado, flooding, or other disasters natural or man-made, civil unrest, strikes, declared or undeclared war, or lack of performance by, or discontinued product of, supply chain partners whose products, software, operations or management is beyond the control of Bestop;
- Damage resulting in breakage (including without limitation, spontaneous breakage, accidental breakage or breakage by any other means) of a Product or any component part;
- Damage to vinyl windows due to misuse, or cracking due to varying weather conditions.

YOUR SOLE REMEDY

During the applicable warranty period, Bestop shall, at its option, either repair or replace any Product that it confirms, in its discretion, is non-compliant with the warranties herein. Bestop will not pay for labor charges associated with installation or removal of the Product. Should a specific Product be discontinued, Bestop may, at its option, replace the discontinued Product with a current product or like product.

Please retain your proof of purchase. Original proof of purchase for the Product must accompany any warranty claim. If you have a warranty claim, first you must email Bestop Customer Service at csbestop@bestop.com for instructions. All claims must be emailed to csbestop@bestop.com within 30 days of discovery of a defective Product, but in no event later than thirty days after the end of the applicable Warranty Period (the "Warranty Notice Period"). Warranty claims made after the Warranty Notice Period are null and void and Bestop shall have no responsibility with respect to such claims.

THIS SECTION SETS FORTH BESTOP'S SOLE OBLIGATION & YOUR SOLE REMEDY WITH RESPECT TO ANY DEFECTS OR OTHER PRODUCT ISSUE. ANY PRODUCTS REPLACED UNDER TERMS OF THIS WARRANTY WILL BE COVERED UNDER TERMS & BALANCE OF THE DURATION OF THE ORIGINAL LIMITED WARRANTY FOR SUCH PRODUCT.



Installation Instructions 2 Piece Soft Doors

Vehicle Application:
Toyota Land Cruiser FJ-40 1964-1984
Part Number 51774

COVERED PRODUCTS AND WARRANTY PERIODS: The warranty time periods are as follows for Products manufactured by Bestop:

BESTOP® LIMITED LIFETIME WARRANTY

Trektop® Pro Twill Fabric Top Sunrider® for Hardtop Twill Fabric Top
Trektop® NX Glide Twill Fabric Top Replace-a-Top™ Twill Fabric Top
Trektop® NX Twill Fabric Top Supertop® NX Twill Fabric Top
EZFold™ Soft Tonneaus Floor & Cargo Liners
ZipRail™ Soft Tonneaus Pet Barriers
EZRoll™ Soft Tonneaus

BESTOP® 5-YEAR LIMITED WARRANTY

Trektop® NX Glide™ Top (non-Twill) Sunrider® for Hardtop (non-Twill) Replace-a-Top™ Top (non-Twill) Trektop® NX Top (non-Twill)
Sailcloth Replace-a-Top™ Supertop® NX Top (non-Twill)
Tigertop™ and Halftop™ Supertop® Classic Soft Top Sunrider® Complete Soft Top Supertop® for Truck
EZ Fold Hard Tonneau

BESTOP® 3-YEAR/100K MILES LIMITED WARRANTY

Powerboard® & Powerboard® NX
Trekstep®, Side Mount
Trekstep®, Rear Mount

BESTOP® 3-YEAR LIMITED WARRANTY

Pavement Ends Sprint Top

BESTOP® 2-YEAR LIMITED WARRANTY

Trektop® Classic Soft Top
RoughRider™ Soft Storage

BESTOP® 1-YEAR LIMITED WARRANTY

All other Bestop® & Pavement Ends™ products not specified above.

For further information or request for warranty work, please contact:

Bestop Inc. Customer Service

Toll-Free: (800)845-3567

E-mail: customerservice@Bestop.com

Website: www.Bestop.com