





Installation Instructions Tinted Window Kit

Vehicle Application

- Jeep Wrangler Unlimited (JK) 4 Door and Bestop Supertop NX
2011 – Current
Part Number: 58135

www.Bestop.com - We're here to help! Visit our web site and click on ["Ask a Question"](#). Click here for more [Jeep Accessories by Bestop](#).

INSTALLATION TIME	SKILL LEVEL
 1/2 Hour	 1 - Easy

TOOLS





 **CAUTION** Safety glasses should be worn at all times while installing this product.

Installation Tips

Before you begin installing this assembly, read all instructions thoroughly.

For a smooth fit:

For ease in installation, the product should be installed at temperatures above 72° F. Below this temperature, the fabric may contract an inch or more, making it difficult to fit to the vehicle. It is normal for fabric to contract and wrinkle when stored in the shipping carton. Within a few days after the installation, the fabric will relax and the wrinkles will disappear.

 **WARNING** This product is designed primarily to enhance the appearance of the vehicle and to shield the occupants from ordinary weather conditions. Do not rely in any way on the components of this product to contain occupants within the vehicle, or to protect against injury or death in the event of an accident. This product will not protect the occupants from falling objects. Never operate the vehicle in excess of manufacturer's specifications.

WEAR SEAT BELTS AT ALL TIMES

Read and follow, precisely, all installation instructions provided when installing product. Failure to do so may result in a poor fit and could place occupants of the vehicle in a potentially dangerous situation.

JK Unlimited Tinted Windows – Installation Instructions

Parts List

Quarter Window, Right	Qty - 1
Quarter Window, Left	Qty - 1
Rear Window	Qty - 1

1 Remove Quarter Windows and Rear Window

Remove the Quarter Windows and the Rear Window. Remove the metal Tailgate Bar from the bottom of the Rear Window and set it aside.

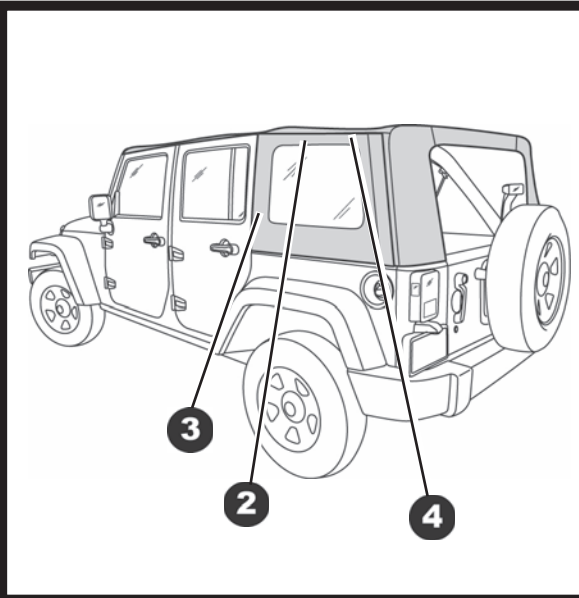

2 Attach Quarter Window Zippers

Start the zipper on the Quarter Window and close it 1-2 inches.

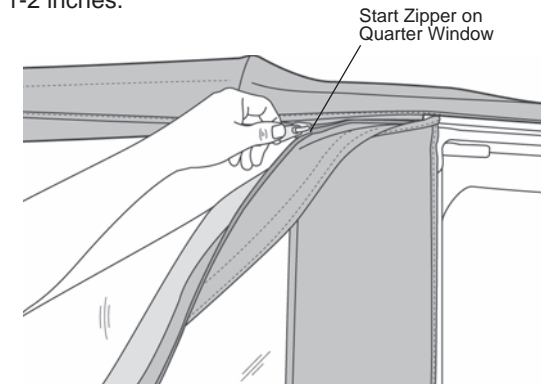

3 Secure Front of Quarter Window

Roll the plastic strip along the front of the Quarter Window into the channel in the Door Surround.

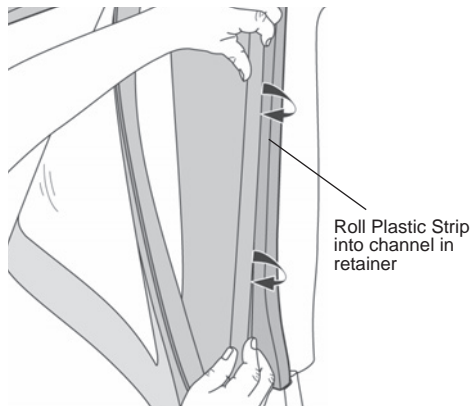

When installed correctly, there will be only one (1) stitch line visible and it will be facing the door opening

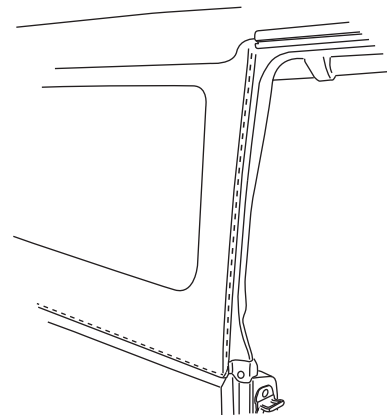

4 Secure Quarter Window

Close the zipper and slip the plastic along the bottom of the Side Window into the channel on the vehicle.

Fasten the hook and loop strip above the window to the top.

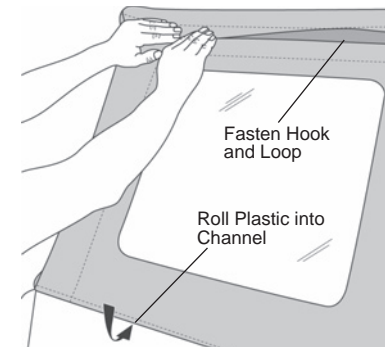

JK Unlimited Tinted Windows – Installation Instructions

5 Install Tailgate Bar on Rear Window

Remove the Rear Window from the box and lay it flat with the backing side up. Locate the Tailgate Bar set aside in Step One. The bar has a “C” shaped channel, when viewed from the end. Orient the bar with the round seal down and slide the “C” channel on the retainer onto the tubed strip sewn to the backing side of the Rear Window.

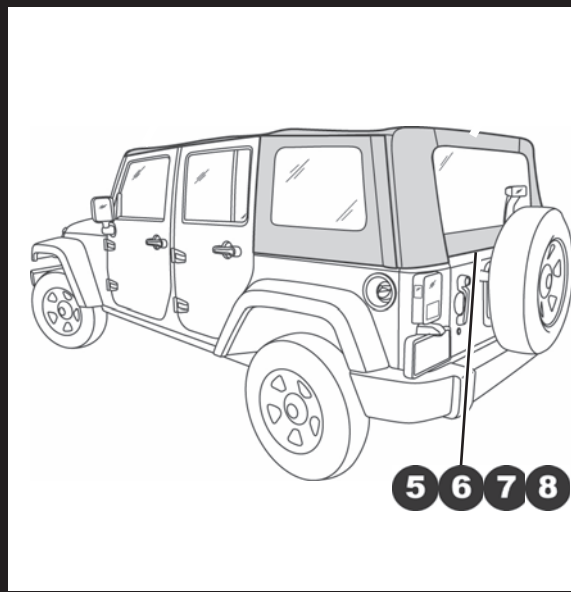
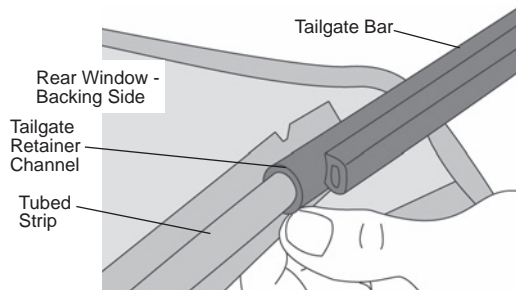

8 Secure Rear Window Flaps

Inside the top locate the flaps sewn to the top on each side of the rear window opening. Pull the flaps over to cover the zipper and fasten the hook strip on the top flap to the loop on the Rear Window.

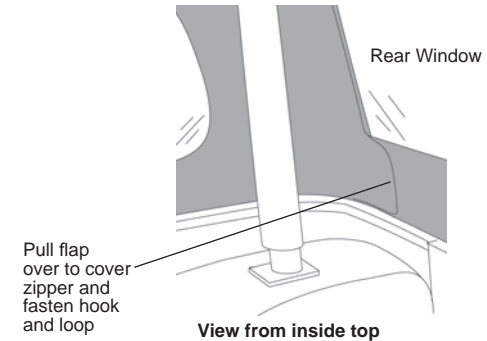

6 Install Tailgate Bar on Vehicle

Insert the Tailgate Bar into the mounts on each side of the tailgate opening with the vinyl side of the Rear Window toward the outside of the vehicle.

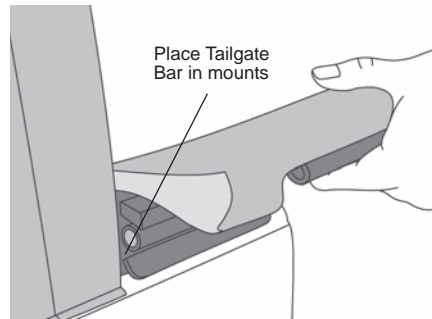

7 Secure Rear Window Zippers

To start the zipper, pull the two sliders as far down as possible on the driver's side of the window in order to catch the sliders to the pin.

Once the zipper is caught, start the top slider 1/2". Then hold up the top of the window with one hand and close the zipper with the other. The zipper is sandwiched between layers of fabric in the corners so be careful not to catch extra fabric in the zipper. Close the zipper.

Make sure that the Tailgate Bar is centered and is securely in the mounts. Then tuck the flaps on the Rear Window under the top fabric.

Slip the plastic at the bottom edge on both sides into the tailgate mounts.

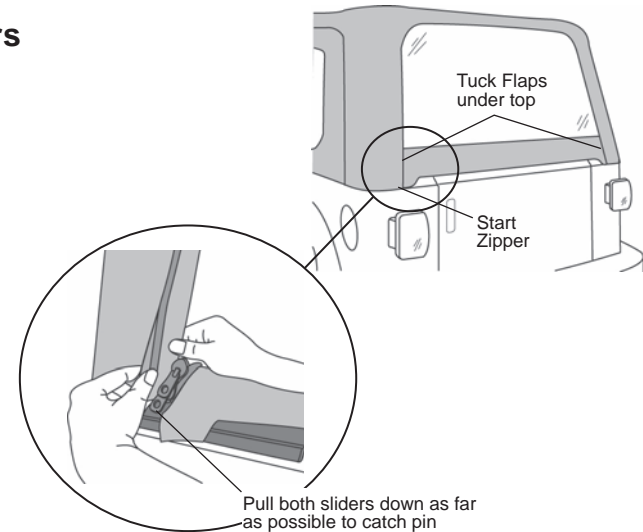



Care and Maintenance of your Bestop Product

Your Bestop product is made of the finest materials available. To keep it looking new and for the maximum possible wear, it will need periodic cleaning and maintenance.

Fabric: The fabric should be washed often using soap, warm water and a soft bristle brush. Rinse with clear water to remove all traces of soap. Bestop recommends using Bestop Cleaner (part no. 11201-00) and Bestop Protectant (part no. 11202-00) for Vinyl fabric and Bestop Twill Protectant (part no. 11207-00) for Twill fabric. Bestop Cleaner and Bestop protectant are specially formulated to provide a total cleaning and protection system. Bestop Cleaner safely removes the toughest stains, will not harm vehicle finishes, is biodegradable and environmentally friendly. Bestop Protectant protects against UV-fading, cracking and hardening, and repels dust, grease, dirt and mildew.

Windows: Keep windows clean to avoid scratching. DO NOT use a brush on the windows! Wash with a water-soaked cloth or sponge and a mild dishwashing detergent. Bestop recommends Bestop Vinyl Window Cleaner (part no. 11203-00), which safely cleans and protects vinyl windows and helps prevent UV damage. NEVER WIPE THE WINDOWS WHEN THEY ARE DRY. Be careful when cleaning snow or frost from the vinyl windows since they are easily scratched and may crack at low temperatures. DO NOT roll the sides or rear window in cold weather. The windows become stiff and will crack. Cracks caused by misuse in cold temperatures are not covered under warranty.

Water: Seeping through at the seams may be stopped by applying 3-M Scotchgard® on the inside of the seams.

Snaps: Keep snaps cleaned and lubricated with silicone to help prevent snaps from sticking to the studs. If a snap does become stuck to a stud, use a screwdriver and GENTLY pry apart to prevent permanent damage to the snap or the top fabric.

Zippers: Keeping zippers cleaned and lubricated with Bestop's Zipper Cleaner (part no. 11206-00) will help prevent damage and keep the zippers in smooth working condition. If a zipper opens behind the slider, the slider may have been spread apart. This problem can usually be repaired by using an ordinary pair of pliers to bring the sides back into parallel. Return slider to the end of the zipper in the normal Open position. Squeeze lightly at first and test the zipper. If the zipper continues to remain open squeeze more firmly with the pliers and try the zipper again. Repeat this procedure until the zipper operates correctly.

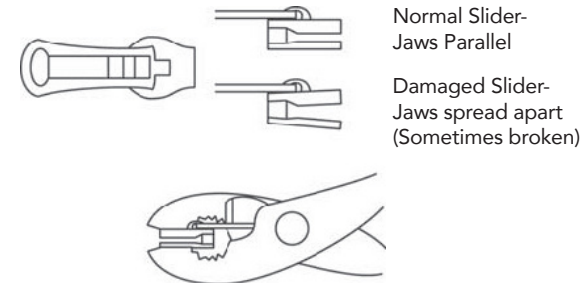

For Bestop Warranty Information, Please go to;
<https://www.bestop.com/help/warranty-information/>

