



Installation Instructions

JL 4 Door Replacement Window (Tint)

Vehicle Application:
JL Wrangler Unlimited 2018-Current
(Left Side)
Part Number 58303

Before you begin installing your new Replacement Window, please read all the instructions thoroughly..

WARNING

Do not rely in any way on the components of this product to protect against injury or death in the event of an accident. Never operate the vehicle in excess of manufacturer's specifications.

Read and follow, precisely, all installation instructions provided when installing this product. Failure to do so may result in a poor fit and could place occupants of the vehicle in a potentially dangerous situation.

"For easier installation, the window should be installed at a temprature above 72° F. Below this temprature, the fabric may contract making it difficult to fit the vehicle."

CAUTION

Safety glasses should be worn at all times when installing this product.

WEAR SEAT BELTS AT ALL TIMES

Tools		Time and Difficulty	
 Safety Glasses	 T15, Torx Driver	 15 Minutes	 2 - Moderatly Easy

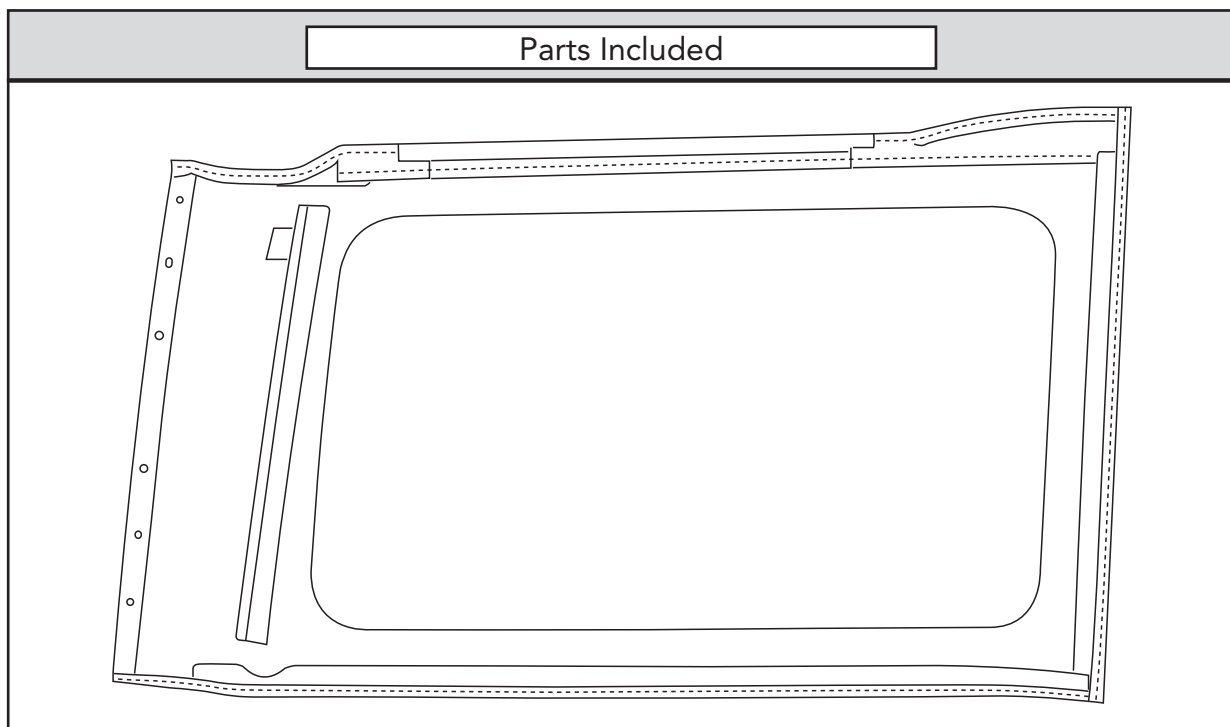

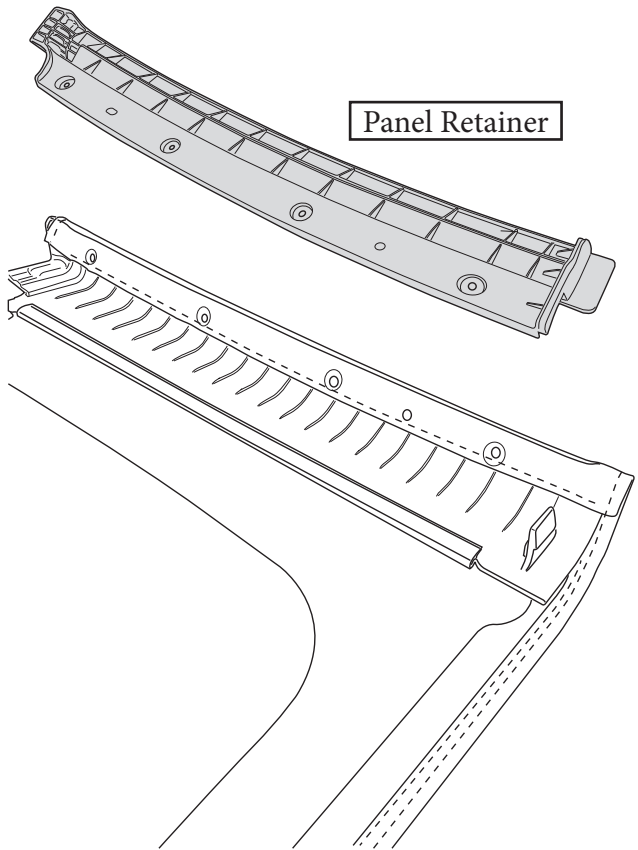
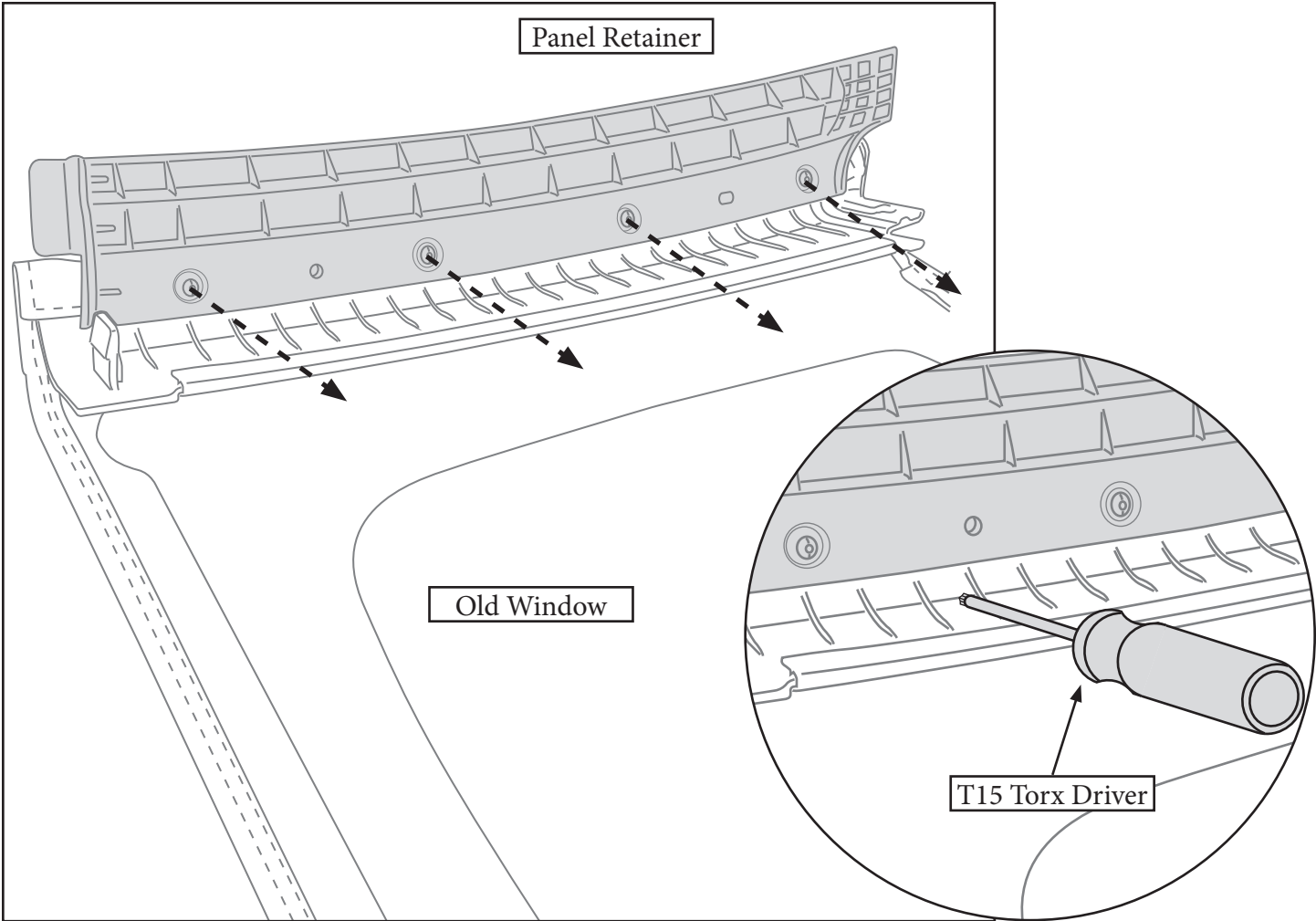

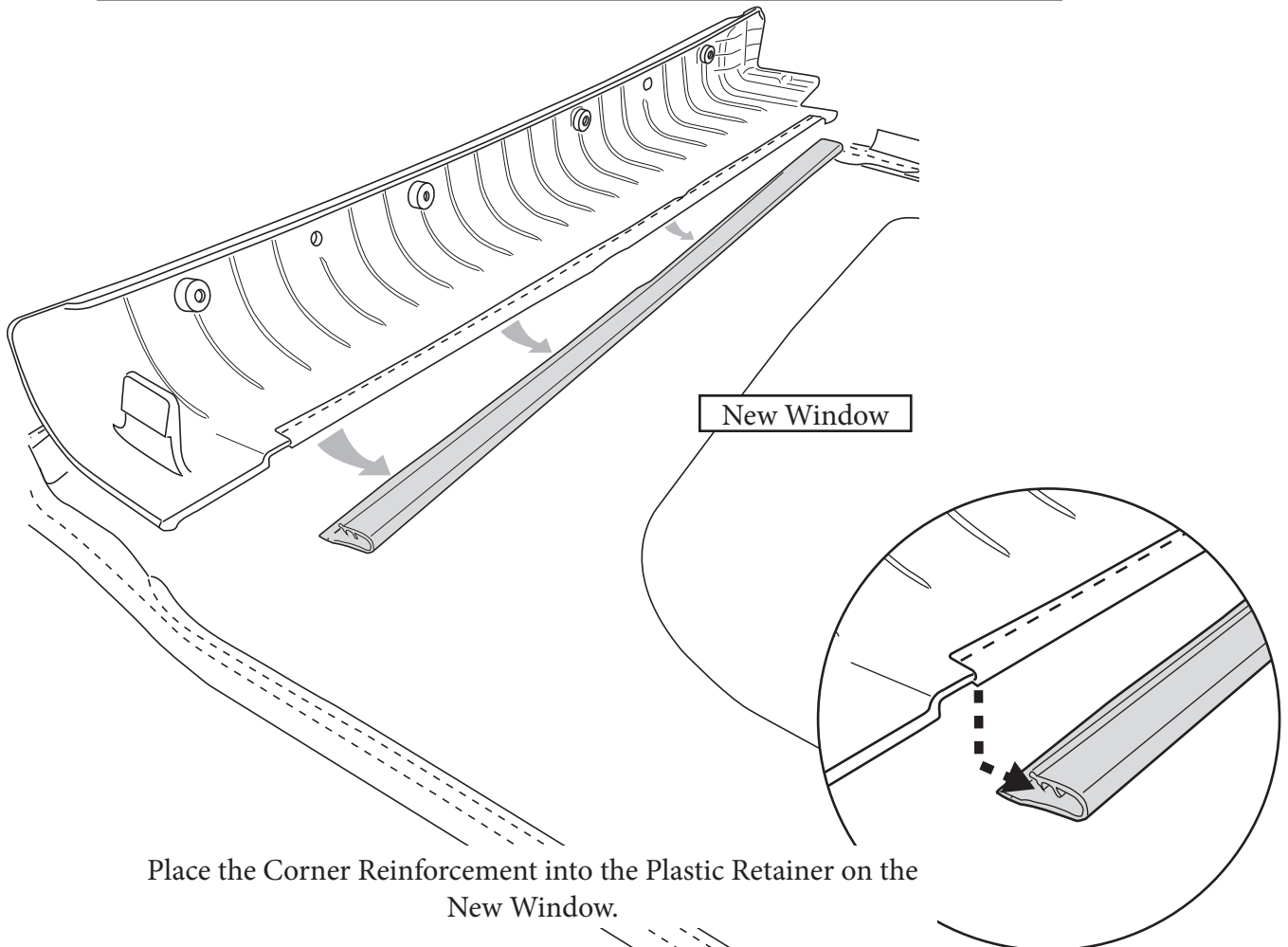
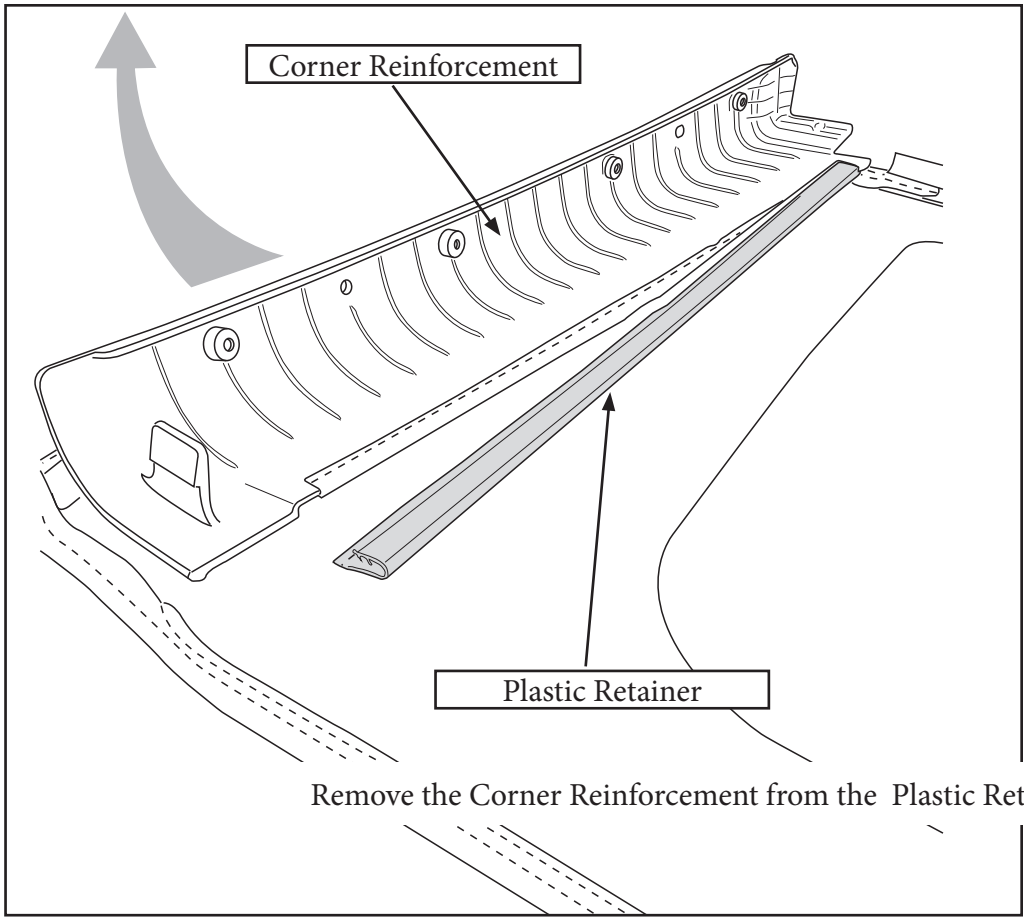

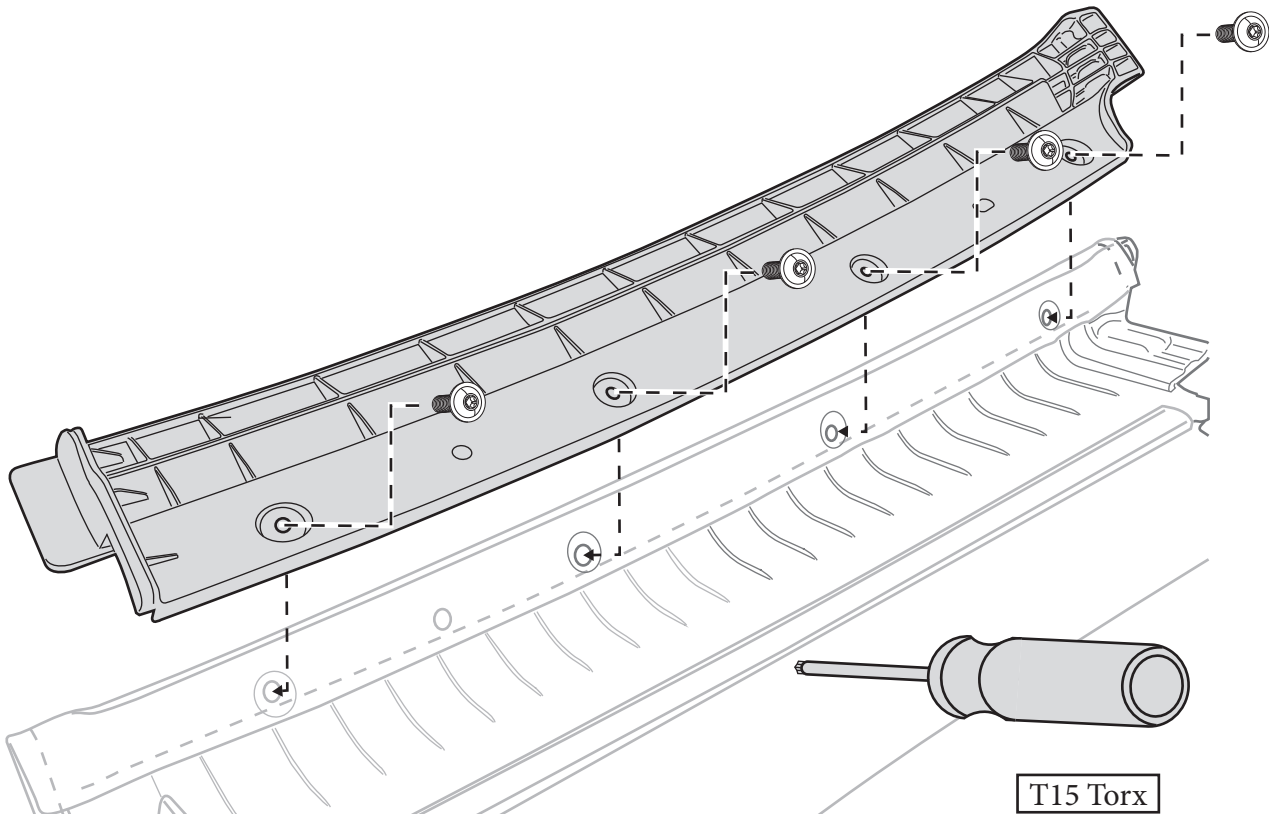
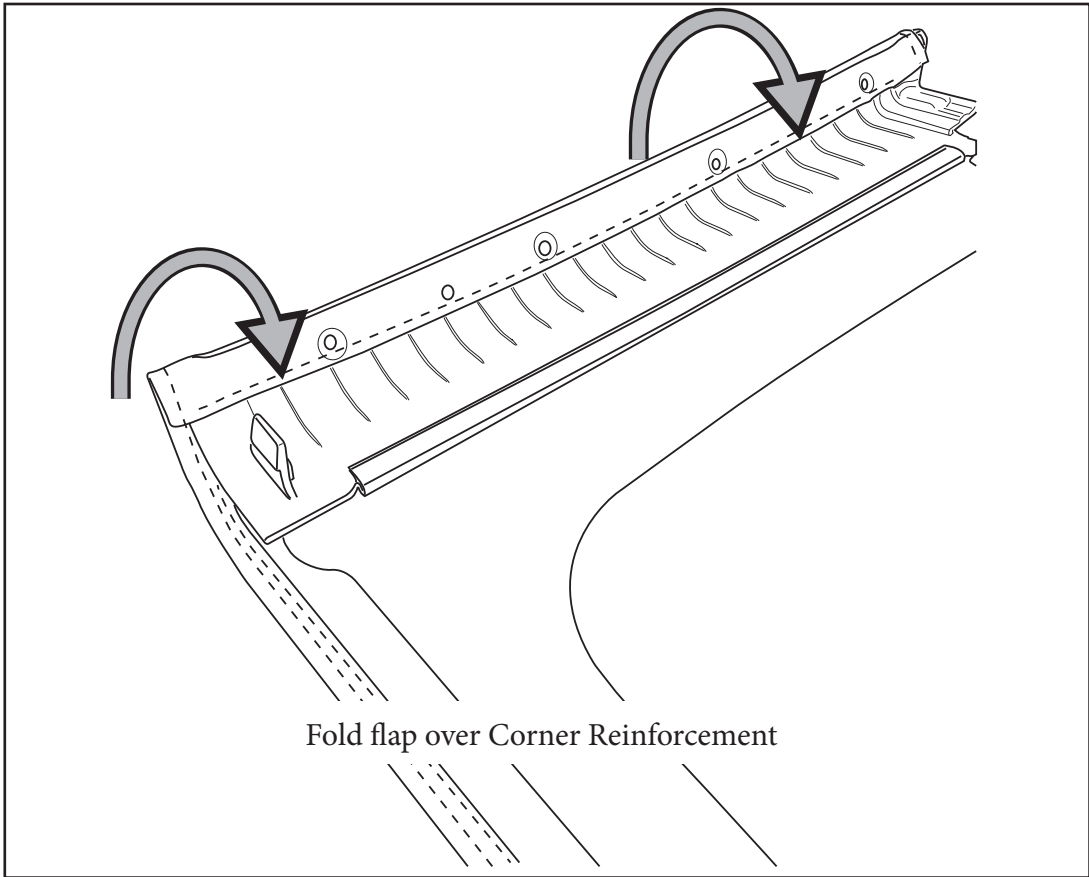

Warranty Information

WHAT BESTOP WARRANTS

Subject to the terms and conditions of sale, including any terms and conditions set forth by Bestop, Inc. ("Bestop" or "us" or "we") in our then-current terms of sale on our website (collectively, the "Terms"), Bestop represents and warrants that: the covered products listed in the "Covered Products and Warranty Periods" section (a "Product") will substantially be free from defects in materials and workmanship for the specified warranty periods set forth in that section.

THE WARRANTY IS LIMITED AND CONDITIONAL

This warranty applies to the original purchaser of the Product only. The warranty is valid only as long as the original retail purchaser owns the vehicle upon which the Product is installed. The warranty expires should the Product be removed from the original vehicle or if the original vehicle is transferred to another owner. This warranty is not transferable or assignable. The warranty does not apply to Product bought from auction-style or price-bid websites.

THE LIMITED WARRANTY AND STATED REMEDIES ARE SOLE AND EXCLUSIVE AND IN LIEU OF ALL OTHER WARRANTIES AND REMEDIES, AND COMPANY EXPRESSLY DISCLAIMS ALL IMPLIED OR STATUTORY OR OTHER WARRANTIES, INCLUDING WITHOUT LIMITATIONS WARRANTIES OF MERCHANTABILITY, NON-INFRINGEMENT OR FITNESS FOR A PARTICULAR PURPOSE. IN NO EVENT WILL COMPANY BE LIABLE FOR ANY SPECIAL, INCIDENTAL, CONSEQUENTIAL, PUNITIVE, INDIRECT OR EXEMPLARY DAMAGES OF ANY KIND, INCLUDING LOST PROFITS OR REVENUE, HOWEVER CAUSED, WHETHER FOR BREACH OR REPUDIATION OF CONTRACT, TORT, BREACH OF WARRANTY, NEGLIGENCE, OR OTHERWISE, WHETHER OR NOT COMPANY WAS ADVISED OF THE POSSIBILITY OF SUCH LOSS OR DAMAGES.

Some states do not allow exclusion or limitation, so this may not apply to you. This warranty gives you specific legal rights, and you may have other rights which vary from state to state.

EXCLUSIONS TO THE WARRANTY

The Limited Warranty excludes, and Bestop is not liable in any way for any warranty claims, damages, or defects related to:

- Misuse, abuse, accidents, vandalism, negligence, fire, or improper installation or modification, or improper or inadequate maintenance;
- Failure to comply with any Product documentation, Bestop instructions, or applicable law or regulations; use in extreme conditions
- Force Majeure including but not limited to, earthquake, hurricane, tornado, flooding, or other disasters natural or man-made, civil unrest, strikes, declared or undeclared war, or lack of performance by, or discontinued product of, supply chain partners whose products, software, operations or management is beyond the control of Bestop;
- Damage resulting in breakage (including without limitation, spontaneous breakage, accidental breakage or breakage by any other means) of a Product or any component part;
- Damage to vinyl windows due to misuse, or cracking due to varying weather conditions.

YOUR SOLE REMEDY

During the applicable warranty period, Bestop shall, at its option, either repair or replace any Product that it confirms, in its discretion, is non-compliant with the warranties herein. Bestop will not pay for labor charges associated with installation or removal of the Product. Should a specific Product be discontinued, Bestop may, at its option, replace the discontinued Product with a current product or like product.

Please retain your proof of purchase. Original proof of purchase for the Product must accompany any warranty claim. If you have a warranty claim, first you must email Bestop Customer Service at csbestop@bestop.com for instructions. All claims must be emailed to csbestop@bestop.com within 30 days of

discovery of a defective Product, but in no event later than thirty days after the end of the applicable Warranty Period (the "Warranty Notice Period"). Warranty claims made after the Warranty Notice Period are null and void and Bestop shall have no responsibility with respect to such claims.

THIS SECTION SETS FORTH BESTOP'S SOLE OBLIGATION & YOUR SOLE REMEDY WITH RESPECT TO ANY DEFECTS OR OTHER PRODUCT ISSUE. ANY PRODUCTS REPLACED UNDER TERMS OF THIS WARRANTY WILL BE COVERED UNDER TERMS & BALANCE OF THE DURATION OF THE ORIGINAL LIMITED WARRANTY FOR SUCH PRODUCT.

Warranty Information

COVERED PRODUCTS AND WARRANTY PERIODS: The warranty time periods are as follows for Products manufactured by Bestop:

BESTOP® LIMITED LIFETIME WARRANTY

Trektop® Pro Twill Fabric Top Sunrider® for Hardtop Twill Fabric Top
Trektop® NX Glide Twill Fabric Top Replace-a-Top™ Twill Fabric Top
Trektop® NX Twill Fabric Top Supertop® NX Twill Fabric Top
EZFold™ Soft Tonneaus Floor & Cargo Liners
ZipRail™ Soft Tonneaus Pet Barriers
EZRoll™ Soft Tonneaus

BESTOP® 5-YEAR LIMITED WARRANTY

Trektop® NX Glide™ Top (non-Twill) Sunrider® for Hardtop (non-Twill) Replace-a-Top™ Top (non-Twill) Trektop® NX Top (non-Twill)
Sailcloth Replace-a-Top™ Supertop® NX Top (non-Twill)
Tigertop™ and Halftop™ Supertop® Classic Soft Top Sunrider® Complete Soft Top Supertop® for Truck
EZ Fold Hard Tonneau

BESTOP® 3-YEAR/100K MILES LIMITED WARRANTY

Powerboard® & Powerboard® NX
Trekstep®, Side Mount
Trekstep®, Rear Mount

BESTOP® 3-YEAR LIMITED WARRANTY

Pavement Ends Sprint Top

BESTOP® 2-YEAR LIMITED WARRANTY

Trektop® Classic Soft Top
RoughRider™ Soft Storage

BESTOP® 1-YEAR LIMITED WARRANTY

All other Bestop® & Pavement Ends™ products not specified above.

For further information or request for warranty work, please contact:

Bestop Inc. Customer Service
Toll-Free: (800)845-3567
E-mail: csbestop@Bestop.com
Website: www.Bestop.com