



BX1135

2014 Jeep Cherokee Limited/Latitude/Sport (includes Adaptive Cruise) Installation Instructions

Attachment Tab Height: 19-1/2"

Attachment Tab Width: 33-1/4"

Serial Number

Please read BOTH these Installation Instructions and the General Instructions prior to installing or operating this equipment.

- Blue Ox® towing products and accessories are intended to be installed by Blue Ox® Dealers who are familiar with our products and have the equipment and knowledge necessary to do "fit work". If needed, Blue Ox® Dealers can be found at www.blueox.com or by contacting our Customer Care Department at (402) 385-3051.
- Many Blue Ox® baseplates are designed to use existing holes and hardware to mount the baseplate to the towed vehicle. Even though bolts are there, do not assume they are adequate for baseplate mounting. Always use the hardware supplied in the hardware kit and existing hardware as specified in the installation instructions.



If the front of your vehicle looks different than this, please contact us at (402)385-3051.

Reference your vehicle owner's manual for manufacturer's towing specifications.

Bolt Torque Specifications

Torque in Foot-Pounds for Inch Bolts

Bolt Size	Grade 5	Grade 8
1/4"	10	14
5/16"	19	29
3/8"	33	47
7/16"	54	78
1/2"	78	119
5/8"	154	230
3/4"	257	380

Bolt Torque Specifications

Torque in Foot-Pounds for Metric Bolts

Bolt Size	Grade 8.8	Grade 10.9
6MM	6	8
8MM	16	22
10MM	31	40
12MM	54	70
14MM	89	117
16MM	161	230
18MM	222	318



WARNING

Failure to read and follow these instructions could result in separation of the towed vehicle from the tow bar, causing property damage, loss of towed vehicle, personal injury or death.

BX1135
2014 Jeep Cherokee Limited/Latitude/Sport (includes Adaptive Cruise)
Installation Instructions

Instruction Notes: The fascia cover and fascia are removed and reinstalled for the baseplate installation. Some drilling and trimming is required.

Place all components that are removed on a flat, sturdy surface. All items will be reinstalled unless otherwise noted after the baseplate is installed.

The dimensional variations between otherwise identical vehicles can be considerable. While the baseplate was designed for easy installation, it may be necessary to tailor the baseplate slightly to compensate for vehicle manufacturer's tolerances.

The BX8848 4-Diode Wiring Kit is recommended for this vehicle.

NOTICE

- Handling of some cosmetic parts when installing this product may require the use of protective covers, rags, specialty tools, etc. to prevent damage.
- When using power drills be aware of the dangers of torque and drill bit length.
- When using a reciprocating saw be aware of objects behind the cutting surface.
- Use a good quality paint to spray cut edges of frame to prevent rusting.
- Be sure that **ALL** electrical connections are plugged in and accessories are functioning properly before reinstalling the fascia.
- The baseplate is computer tested to your vehicle's GVWR, exceeding this weight will void the manufacturer's warranty.
- Be sure to use Loctite® Red on all bolts before tightening. Tighten all bolts according to the torque chart provided.
- Dealer or installer be certain the user receives these instruction sheet.
- If the baseplate is in an accident, it must be replaced. **DO NOT** use it again! An accident can cause unseen damage and using it again could result in more damage or serious injury. **DO NOT** use the baseplate if it is damaged or missing parts.

BX1135

2014 Jeep Cherokee Limited/Latitude/Sport (includes Adaptive Cruise)

Installation Instructions

Tools Required

Flat Screwdriver
 Utility Knife
 Torque Wrench
 Tape Measure
 Loctite® RED
 7MM Socket
 8MM Socket
 10MM Socket
 15MM Socket

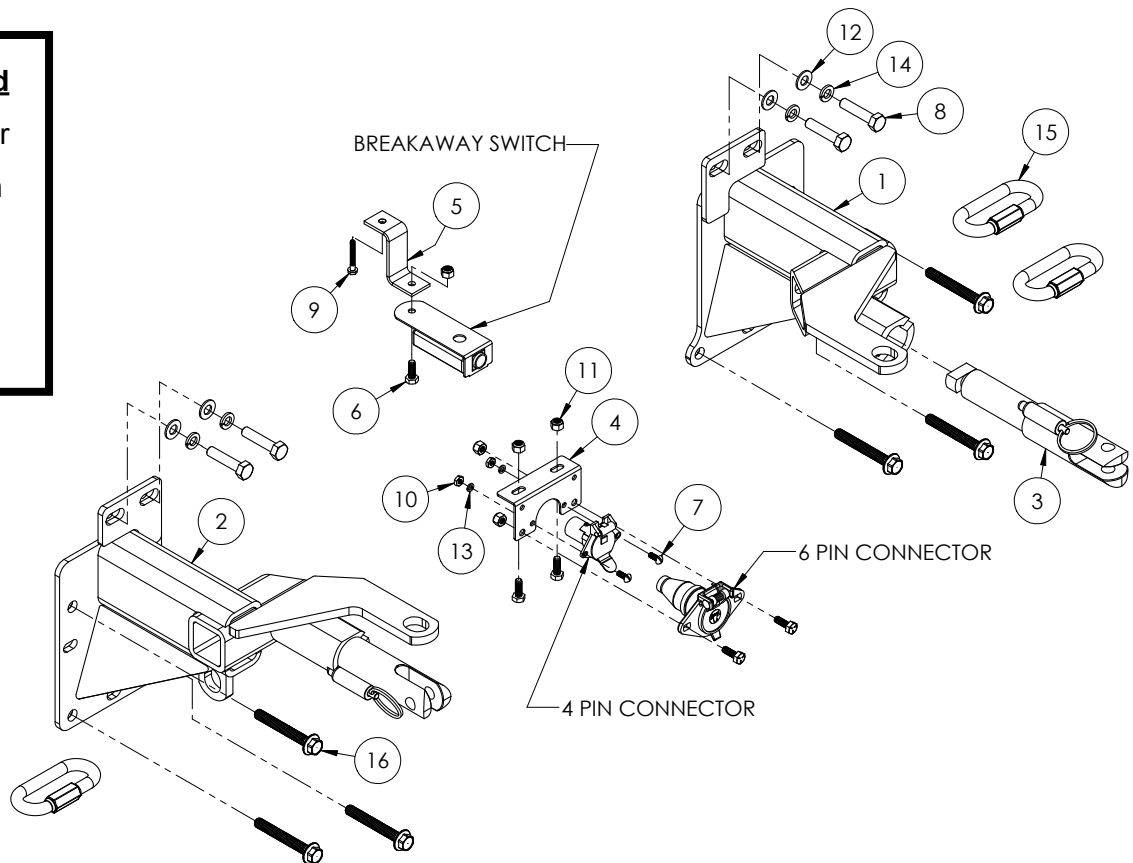

Item No.	Part No.	Description	Qty.
1.....	61-7291	BX1135 DS Baseplate	1
2.....	61-7292	BX1135 PS Baseplate	1
3.....	62-3469	Attachment Tab Assembly with Hole	2
4.....	101-6135.....	Electrical Bracket.....	1
5.....	102-7056	Breakaway Bracket	1
6.....	201-0050	1/4"-20 x 3/4" Hex Head Bolt, Grade 5, ZP	5
7.....	201-0192	#10-32 1/2" Round Slotted Head Screw.....	2
8.....	201-0594	10MM-1.25 x 40MM Hex Head Bolt, Grade 8.8, ZP.....	4
9.....	201-0654	#10-16 x 1" Self Drilling Screw, ZP.....	1
10.....	202-0047	#10-32 Hex Nut	2
11.....	202-0102	1/4"-20 Hex Nylon Nut, ZP	5
12.....	203-0003	3/8" Flat Washer, ZP.....	4
13.....	203-0054	#10 Lock Washer, ZP	2
14.....	203-0104	10MM Lock Washer, ZP	4
15.....	229-0512	1/2" Quicklink, ZP	3
16.....	Existing.....	10MM Bolt	6
17.....	226-0049(not shown)	Class IV Safety Cables.....	2
18.....	290-0437(not shown)	Black Cap Plug Receiver.....	2

Important:

Use only genuine factory replacement parts on your baseplate. Do **NOT** substitute homemade or non-typical parts. If a bolt is lost or in need of replacement, for your safety and the preservation of your baseplate, be sure to use a replacement bolt of the same grade (In most cases it will be Grade 5, please reference the parts list above). Replacement parts may be ordered through your nearest Blue Ox® Dealer or Distributor. Failing to follow and/or altering these installation instructions in either installation or required equipment will void the manufacturer's warranty. Towing behind a non-motorized vehicle will void the warranty.

2014 Jeep Cherokee Limited/Latitude/Sport (includes Adaptive Cruise)
Installation Instructions

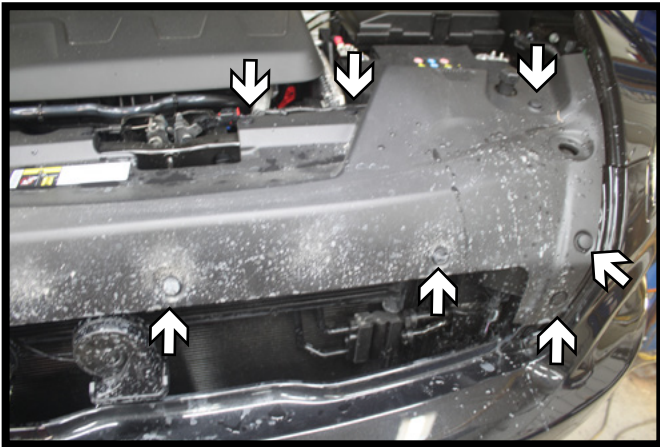

1. Remove the twelve (12) push pins from the top edge of the fascia cover and set aside.

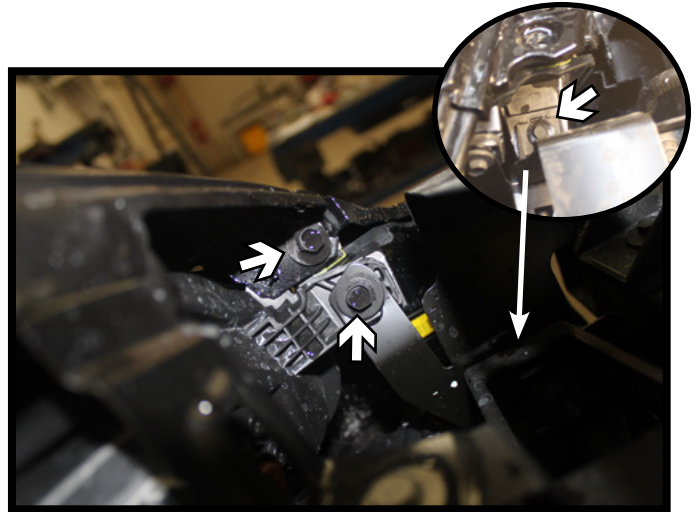

2. Using a 10MM socket, remove the three (3) screws from the backside of the fascia next to the fender. There are two (2) in the corner and one (1) directly below the bracket (inset). Do this on both sides of the vehicle.



3. Using a 8MM socket, remove the three (3) screws from the edge of the wheel well. Using a 7MM socket, remove the one (1) screw at the fascia/trim joint (gray). Using a 10MM socket, remove the screw behind the trim (inset). Do this on both sides of the vehicle.



4. Remove the four (4) rivets from the underside corners of the fascia (inset). There are two (2) on each side. Using a 10MM socket, remove the four (4) screws from the middle portion of the fascia.

BX1135

2014 Jeep Cherokee Limited/Latitude/Sport (includes Adaptive Cruise) Installation Instructions



5. Lift the corners of the fascia up towards the fender (white) and out to release (gray). Continue along under the headlights unsnapping the fascia from the vehicle. Set the fascia aside.

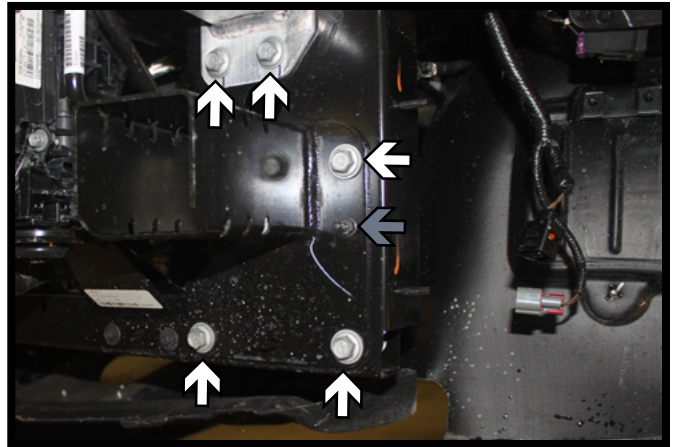

6. Using a 15MM socket, remove the three (3) bolts from the frame extension and two (2) bolts from the bottom side of the bumper (white). Using a 10MM socket, remove the nut from the fascia extension (gray). Do this on both sides of the vehicle. The extensions will not be reinstalled.

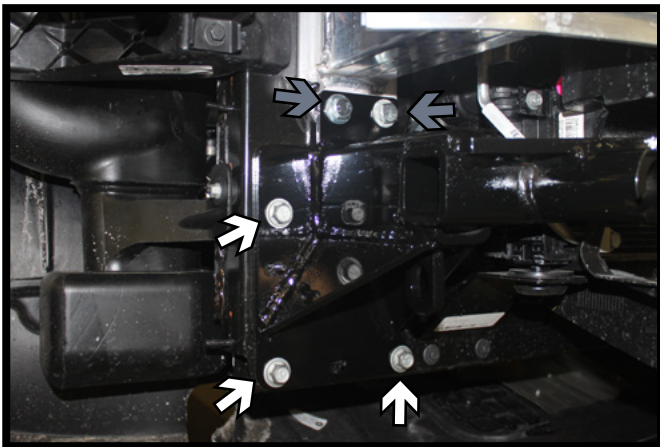

7. Install the baseplate to the vehicle using the three (3) existing extension bolts (white). Install 10MM-1.25 x 40MM bolts with 3/8" flat washers and 10MM lock washers into the lower bumper bolts (gray). Fully tighten all fasteners. Do this on both sides of the vehicle.

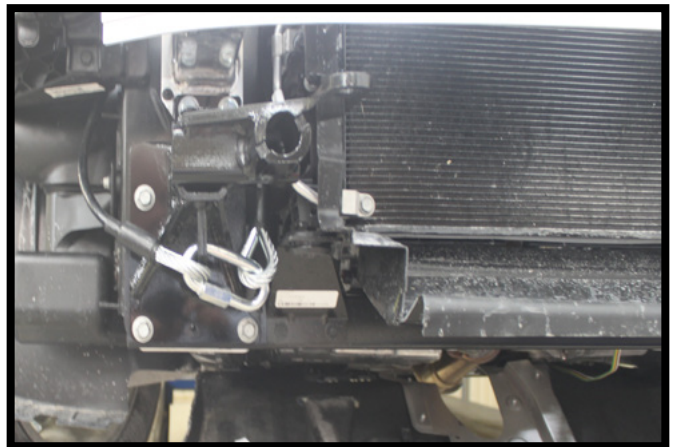

8. Attach the permanent baseplate safety cables to the provided convenience link on the baseplate. The photo above shows the recommended installation of the cables to frame of vehicle. Additional options may interfere with suggested mounting; in this case, secure the cables to a solid piece of the frame as described in the instructions included with the permanent baseplate safety cables. Be sure the safety cables do not rub against any hoses or moving parts. Do this on **BOTH** sides of the vehicle. Note: the driver side requires two (2) quicklinks.

BX1135
2014 Jeep Cherokee Limited/Latitude/Sport (includes Adaptive Cruise)
Installation Instructions

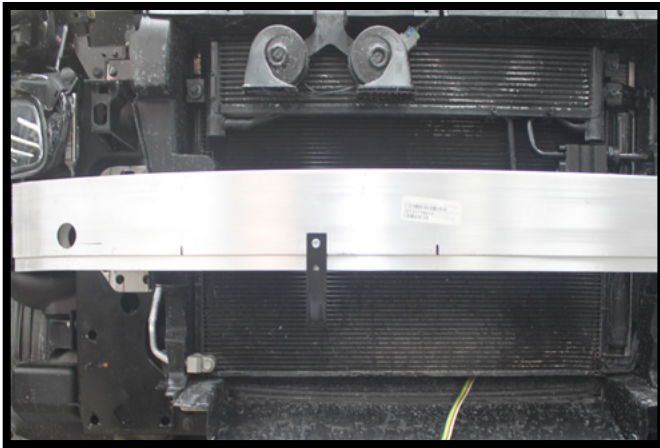

9. **Optional:** If installing a breakaway, screw the breakaway bracket to the bumper at the desired location with the #10-16 x 1" self drilling screw. Attach the breakaway to the bracket with a 1/4"-20 x 3/4" bolt and 1/4"-20 lock nut.

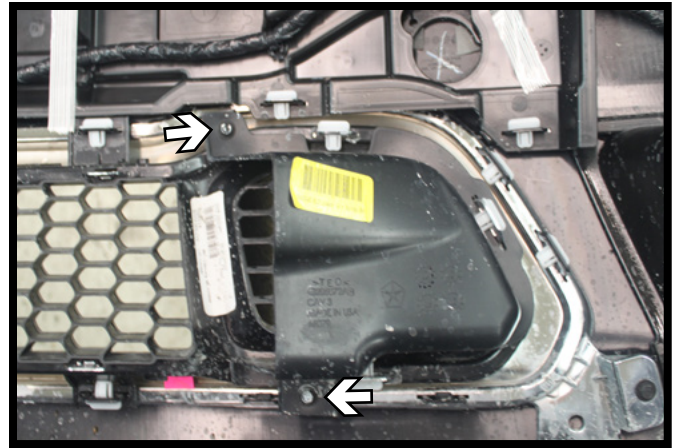

10. Using a 7MM socket, remove the two (2) screws from the cover on the backside of the fascia and unsnap the cover from the fascia. Do this on both sides of the fascia. The covers will not be reinstalled.



11. Hold the fascia as close to its original position, mark and trim the fascia around the convenience links and attachment tabs. Reinstall the fascia and fascia cover.



12. Install the new plastic rivets into the underside of the fascia, where the factory rivets were removed.

BX1135
2014 Jeep Cherokee Limited/Latitude/Sport (includes Adaptive Cruise)
Installation Instructions

CUSTOMER SERVICE COMMITMENT

Blue Ox® is committed to providing you with exceptional customer care throughout your lifetime with our products. Our team is here to assist you with any questions you may have regarding the performance of your product. Simply call (402) 385-3051 and you can speak with our customer care team.

Additionally, please visit our website to see which rallies our Destination America team will be attending. For a nominal fee, our service technician will service your towing system to ensure it's in proper working condition. Also, as a commitment to our customers, should you visit our factory, you can stay at our full service Blue Ox® campground at no charge along with enjoying a factory tour.

Again, thank you for being our customer and for the confidence you have shown in the performance of our products. It is because of customers like you we enjoy the success we have today.

© 2014 Blue Ox
One Mill Road, Industrial Park
Pender, Nebraska 68047
Phone: (402) 385-3051
Fax: (402) 385-3360
www.blueox.com