



BX1512

2006-11 Buick Lucerne Installation Instructions

Serial Number

Please read BOTH these Installation Instructions and the General Towing Instructions before attempting to install or operate this equipment.

- Blue Ox® towing products and accessories are intended to be installed by Blue Ox® Dealers who are familiar with our products and have the equipment and knowledge to do “fit work”. When necessary, Blue Ox® Dealers can be found at www.blueox.com or by contacting our Customer Care Department at (402) 385-3051.
- Many Blue Ox® Baseplates are designed to use existing holes and hardware to mount the baseplate to the towed vehicle. Even though bolts are there, do not assume they are adequate for baseplate mounting. Always use hardware supplied in the hardware kit or existing hardware specified in the Baseplate Installation Instructions.

Attachment Tab Height: 12-1/2”

Attachment Tab Width: 30”

Bolt Torque Specifications
Torque in Foot-Pounds for Metric Bolts

Bolt Size	Grade 8.8	Grade 10.9
6MM	6	8
8MM	16	22
10MM	31	40
12MM	54	70
14MM	89	117

Confirm the towability and pre-towing procedures for your vehicle with the owner’s manual or contact the vehicle’s manufacturer for specific towing procedures.

Bolt Torque Specifications
Torque in Foot-Pounds for Inch Bolts

Bolt Size	Grade 5	Grade 8
1/4”	10	14
5/16”	19	29
3/8”	33	47
7/16”	54	78
1/2”	78	119
5/8”	154	230



If the front of your vehicle looks different than this, call us at (402) 385-3051.

WARNING

Failure to read and follow these instructions could result in separation of the towed vehicle from the tow bar, causing property damage, loss of towed vehicle, personal injury or death.

BX1512
2006-11 Buick Lucerne
Installation Instructions

Parts List

Ref. No.	Qty.	Part #	Description
1	1	61-6302	Weldment, Cross Tube, BX1512
2	1	61-6279	Weldment, Plate End, DS, BX1511
3	1	61-6280	Weldment, Plate End, PS, BX1511
4	2	61-3799	1/2-13 Nut Plate, with 10" Wire
5	4	61-5208	3/8-16 Nut Plate with 14" Wire
6	2	201-0153	1/2-13 x 2 1/2" Bolt, Grd. 5, ZP
7	4	201-0011	1/2-13 x 1 1/4" Bolt, Grd. 5, ZP
8	4	201-0336	3/8-16 x 2 1/2" Bolt, Grd. 5, ZP
9	6	203-0012	1/2" Lock Washer, ZP
10	4	203-0010	3/8" Lock Washer, ZP
11	2	202-0005	1/2-13 Hex Nut, ZP
12	1	101-6135	Electrical Bracket, 90 Degr.
13	4	201-0050	1/4-20 x 3/4 Hex Bolt, Grd. 5, ZP
14	4	203-0008	1/4" Lock Washer
15	2	203-0001	1/4" Flat Washer
16	4	202-0069	1/4-20 Whiz Hex Nut, ZP
17	2	201-0192	#10-32 x 1/2 Slot, Rd. Hd. Screw
18	2	203-0054	#10 Lock Washer
19	2	202-0047	#10-32 Hex Nut
20	2	101-5822	Adapter, 4 Way Connector
21	2	62-3469	Attachment, Assembly, SF/LB (R)
	2	201-0443	3/8-16 x 1" Hex Bolt, Grd. 5, ZP (Not Shown)
	2	202-0071	3/8-16 Hex Flange Whiz Lock Nut, ZP (Not Shown)
	2	226-0046	Baseplate Safety Cable, 36" CL III (Not Shown)
	2	229-0359	Quicklink, 3/8, ZP (Not Shown)
	2	290-0437	Receiver, Cap Plug, Blk. (Not Shown)

Tools Required

3/4" Socket/Wrench
10mm Socket
13mm Socket
15mm Socket
13/32" Drill Bit
Reciprocating Saw
Tape Measure
Utility Knife
Loctite® RED

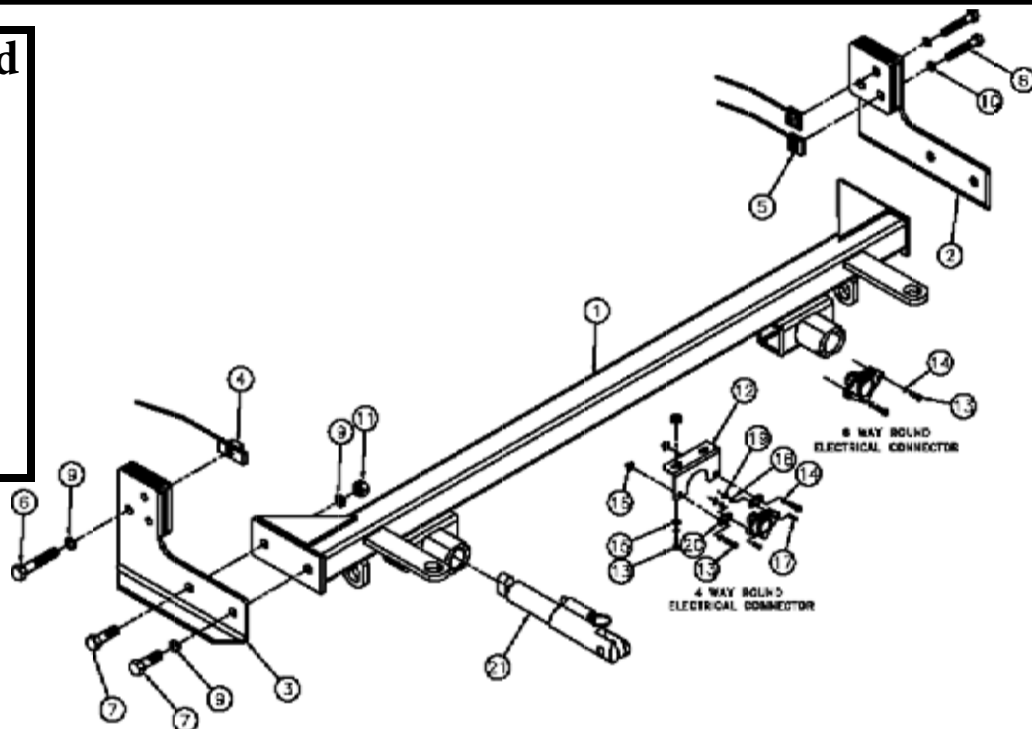

Important:

Use only genuine factory replacement parts on your baseplate. Do **NOT** substitute homemade or non-typical parts. If a bolt is lost or in need of replacement, for your safety and the preservation of your baseplate, be sure to use a replacement bolt of the same grade (In most cases it will be Grade 5, please reference the parts list above). Replacement parts may be ordered through your nearest Blue Ox® Dealer or Distributor. Failing to follow and/or altering these installation instructions in either installation or required equipment will void the manufacturer's warranty. Towing behind a non-motorized vehicle will void the warranty.

BX1512
2006-11 Buick Lucerne
Installation Instructions

Attachment Tabs:

Due to the design of the removable tabs, the RangeFinderII and Ambassador tow bars can not be used. Adapters, except the BX8833 and BX88151, can not be used with this baseplate.

Installation Notes:

The radiator cover, fascia, belly pan and metal bumper are removed for installation. The fascia support is trimmed. Drilling is required. Bumper bracket bolts are not reinstalled.

The dimensional variations between otherwise identical vehicles can be considerable. While the baseplate was designed for easy installation, it may be necessary to tailor the baseplate slightly to compensate for auto manufacturer's tolerances. These minor adjustments may include filing a hole slightly, bending electrical rods or bending end plates.

The BX8869 Bulb and Socket Wiring Kit is recommended for this vehicle.

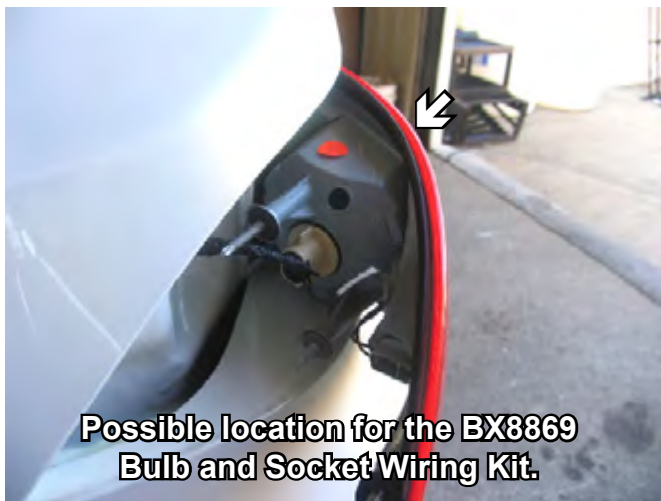

Installation Instructions

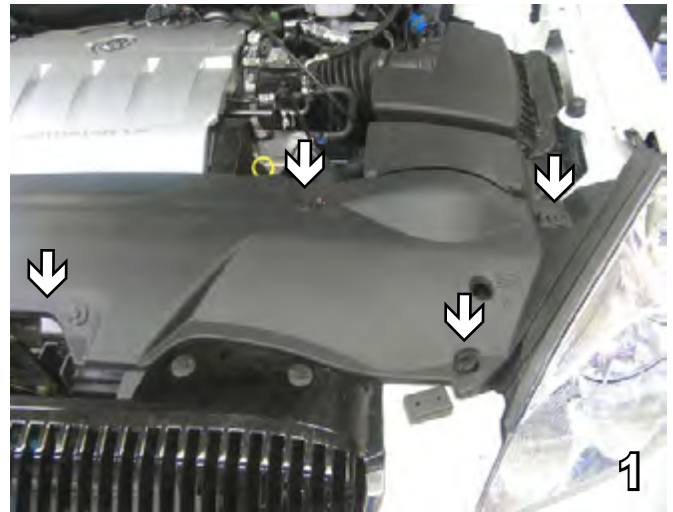

1. Remove four (4) pushpins from the radiator cover and lift to remove. Do this to both sides of the vehicle. Set pushpins and radiator cover aside to be reinstalled later.

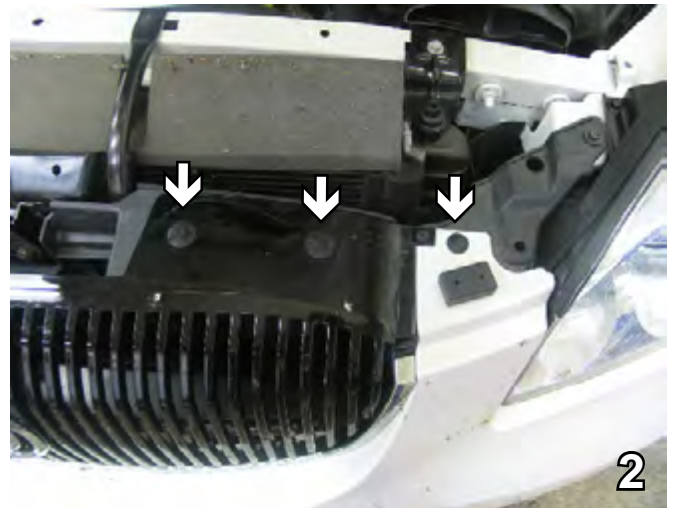

2. Remove three (3) pushpins from the top of the fascia. Do this to both sides of the vehicle. Set pushpins aside to be reinstalled later.

Handling of some cosmetic parts when installing this product may require the use of protective covers, rags, specialty tools, etc. to prevent damage.

BX1512
2006-11 Buick Lucerne
Installation Instructions



3. Remove five (5) pushpins just forward of the front tire, on the edge of fascia. Do this to both sides of the vehicle. Set pushpins aside to be reinstalled later.

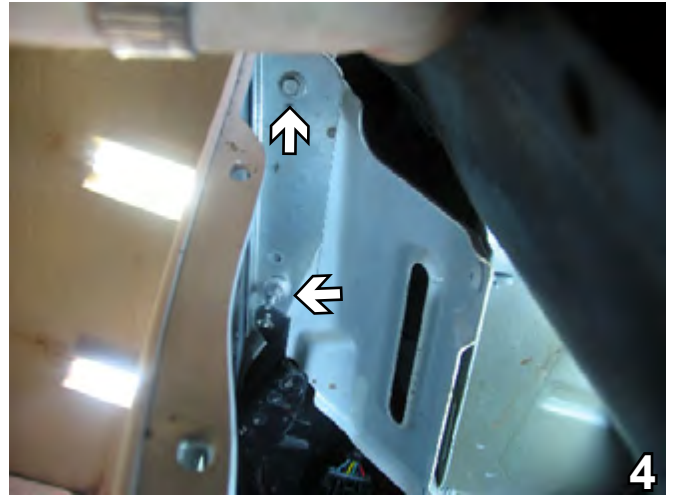

4. Pull wheel well cover aside and remove two (2) metric bolts from back side of fascia using the 10mm socket. Do this to both sides of the vehicle. Set bolts aside to be reinstalled later.

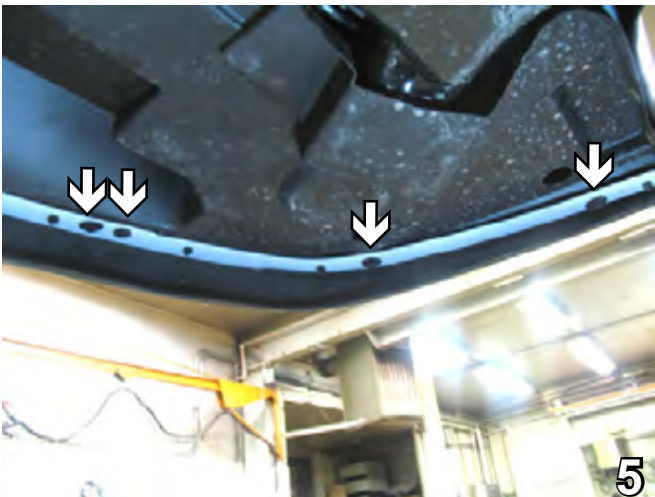

5. Remove four (4) pushpins from the bottom corner of fascia. Do this to both sides of the vehicle. Set pushpins aside to be reinstalled later.



6. Remove two (2) pushpins from the bottom center of fascia. Pull fascia forward to remove. Set pushpins and fascia aside carefully to be reinstalled later.

BX1512
2006-11 Buick Lucerne
Installation Instructions

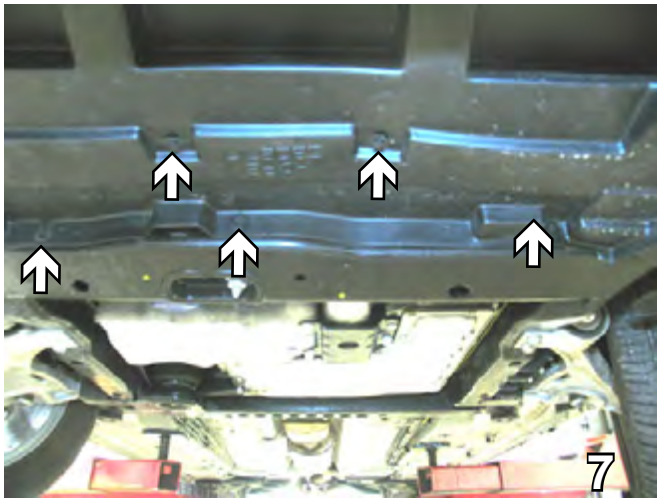

7. Remove five (5) pushpins from the belly pan. Set pushpins and belly pan aside to be reinstalled later.

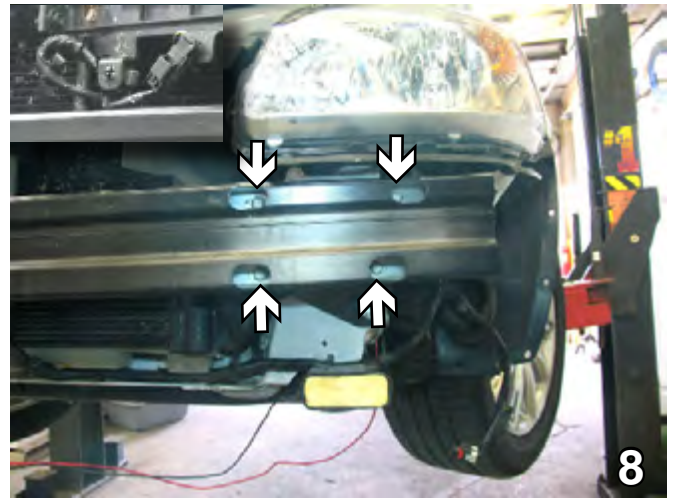

8. Under hood latch area (see inset), disconnect two (2) electrical connections and move out of the way. Using the 13mm socket, remove four (4) metric bolts from the metal bumper. Do this to both sides of the vehicle. Set bolts aside to be reinstalled later.



9. Remove one (1) pushpin fastening the lower section of air dam to the top of the metal bumper. Do this to both sides of the vehicle. Pull metal bumper forward to remove. Set pushpins and metal bumper aside to be reinstalled later.



10. Mark a rectangle on the lower portion of bumper bracket. Start horizontally below the upper portion of bumper bracket (see white arrow) and continue just beyond the lower bolt hole. Then, mark straight down until reaching bottom of frame rail. This vertical marking should be flush with frame rail edge (behind bumper bracket). Using the reciprocating saw, cut marked area through the bumper bracket and frame rail.

BX1512
2006-11 Buick Lucerne
Installation Instructions



11. Using the utility knife, remove three (3) tabs from the lower edge of fascia support. *Note: To prevent scratching, fascia should be lying on a smooth surface.*

BE SURE TO USE LOCTITE® RED ON ALL BOLTS BEFORE TIGHTENING. TIGHTEN ALL BOLTS ACCORDING TO THE TORQUE CHART ON THE FRONT PAGE OF THESE INSTRUCTIONS OR ON PAGE 3 OF THE BASEPLATE TOWING GENERAL INSTRUCTIONS.

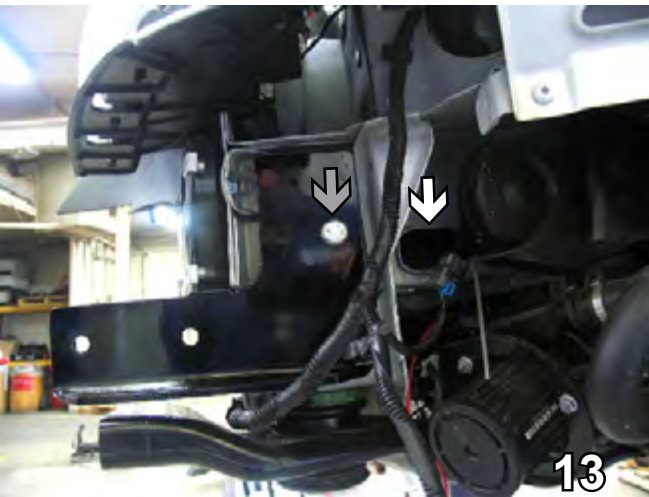

13. Align endplate with existing hole of the frame rail. Insure top of endplate is parallel with frame rail. Insert 1/2"-13 nut plate into frame rail opening (see white arrow) and align to pre-existing hole. Insert 1/2"-13 x 2-1/2" bolt and 1/2" lock washer and tighten (see grey arrow). Do this to both sides of the vehicle.



12. Remove the fascia support from the back of the fascia. Using the utility knife, start a vertical cut 7-1/2" in from the fascia support's inside edge. Cut upward until stopped by molding. Then, cut horizontally until reaching the inside edge. Do this to both sides of the vehicle. Reinstall fascia support to the back of fascia.

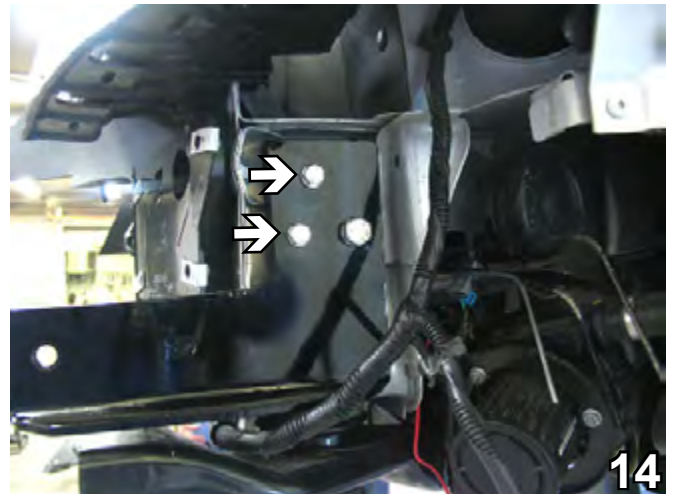

14. Using the endplate as a template, drill two holes into the frame with the 13/32" drill bit. Insert 3/8"-16 nut plates into frame rail opening and align to drilled holes. Insert 3/8"-16 x 2-1/2" bolts and 3/8" lock washers into holes and tighten. Do this to both sides of the vehicle.

When using power drills be aware of the dangers of torque and drill bit length.

BX1512
2006-11 Buick Lucerne
Installation Instructions

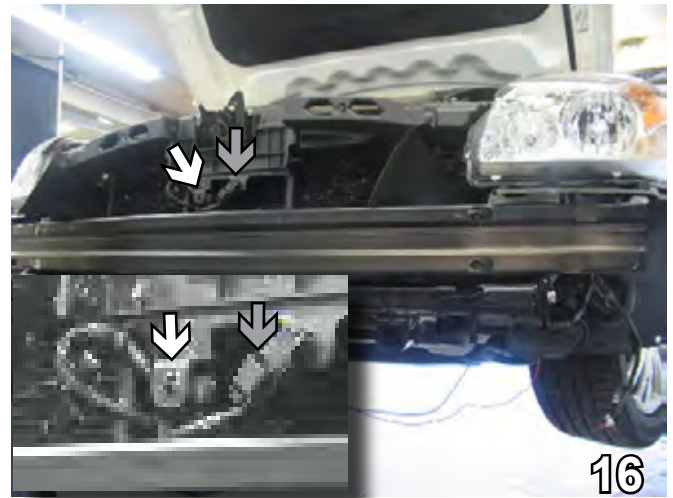

15. Place cross tube between the endplates (see grey arrows). Insert 1/2"-13 x 1-1/4" bolts into the endplate's two (2) front holes (see white arrows of inset). Tighten the forward most bolt and 1/2" lock washer to the weld nut in the cross tube. Tighten the other front bolt to the 1/2" lock washer and 1/2"-13 hex nut. Do this to both sides of the vehicle.

16. When reinstalling electrical connections under hood latch area, the tab-style connector goes to it's original location (see grey arrow). Snap the other connector into place (see white arrow), entering from the backside of it's bracket, (rather than from the front).

Be sure that **ALL** electrical connections are plugged in properly and functioning **BEFORE** installing the fascia.

DEALER or INSTALLER:
Be certain the user receives the instruction sheets for their products.

17. Reinstall belly pan, metal bumper, fascia, radiator cover, pushpins and bolts.

Install the tow bar and safety cables according to the instructions provided in their packages. When demonstrating this to the customer, be sure to include all the contents and packages.

Do **NOT** substitute other devices if the tow bar pins and clips are misplaced.

18. When replacing the fascia on the vehicle, the fascia will need to be trimmed to fit the removable tabs through.



BX1512
2006-11 Buick Lucerne
Installation Instructions

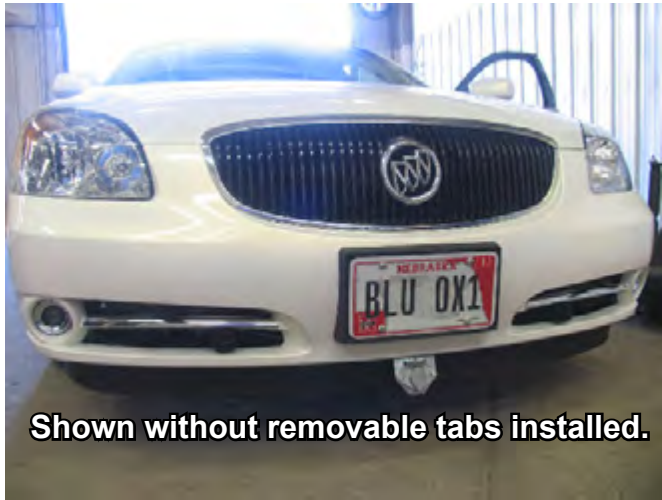

Shown without removable tabs installed.

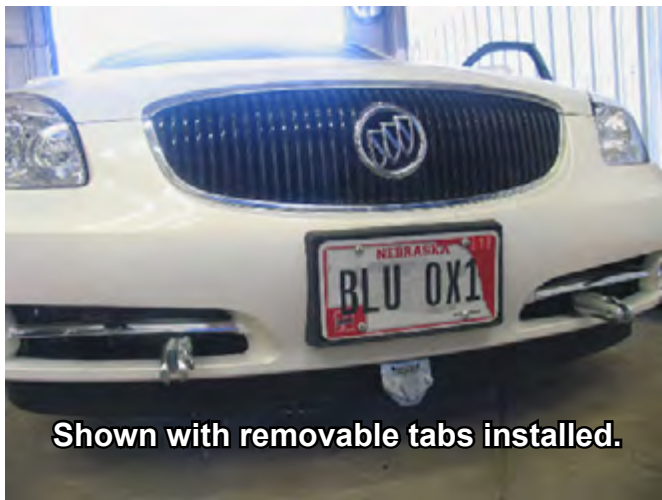

Shown with removable tabs installed.

If the baseplate is in an accident, it must be replaced. DO NOT use it again! An accident can cause unseen damage and using it again could result in more damage or serious injury. DO NOT use the baseplate if it is damaged or missing parts.

CUSTOMER SERVICE COMMITMENT

Blue Ox is committed to providing you with exceptional customer care throughout your lifetime with our products. Our team is here to assist you with any questions you may have regarding the performance of your product. Simply call (402) 385-3051 and you can speak with our customer care team.

Additionally, please visit our website to see which rallies our Destination America team will be attending. For a nominal fee, our service technician will service your towing system to ensure it's in proper working condition. Also as a commitment to our customers, should you visit our factory you can stay at our full service Blue Ox campground at no charge along with enjoying a factory tour.

Again thank you for being our customer and for the confidence you have shown in the performance of our products. It is because of customers like you we enjoy the success we have today.



© 2006, 07, 08, 09, 10 Blue Ox
One Mill Road, Industrial Park
Pender, Nebraska 68047
Phone: (402) 385-3051 • Fax: (402) 385-3360
www.blueox.com